

# picture this

For intuitive, intelligent and easy non-destructive testing imaging, focus on GE. Our portfolio covers a full range of inspection modalities—from ultrasonic and radiographic to remote visual and eddy current.

Our advanced technology solutions, software and services can help you acquire the data you need to make informed decisions about productivity, safety and quality.

Now part of the picture is **phoenix|x-ray**, a leader in high-resolution CT and x-ray technology. **phoenix|x-ray** joins AGFA NDT, Everest VIT, Hocking NDT, Krautkramer, Nutronik and Seifert to become the company with all your inspection solutions—GE Sensing & Inspection Technologies.



[www.geinspectiontechnologies.com/en](http://www.geinspectiontechnologies.com/en)



# Industrial Radiography

Image forming techniques

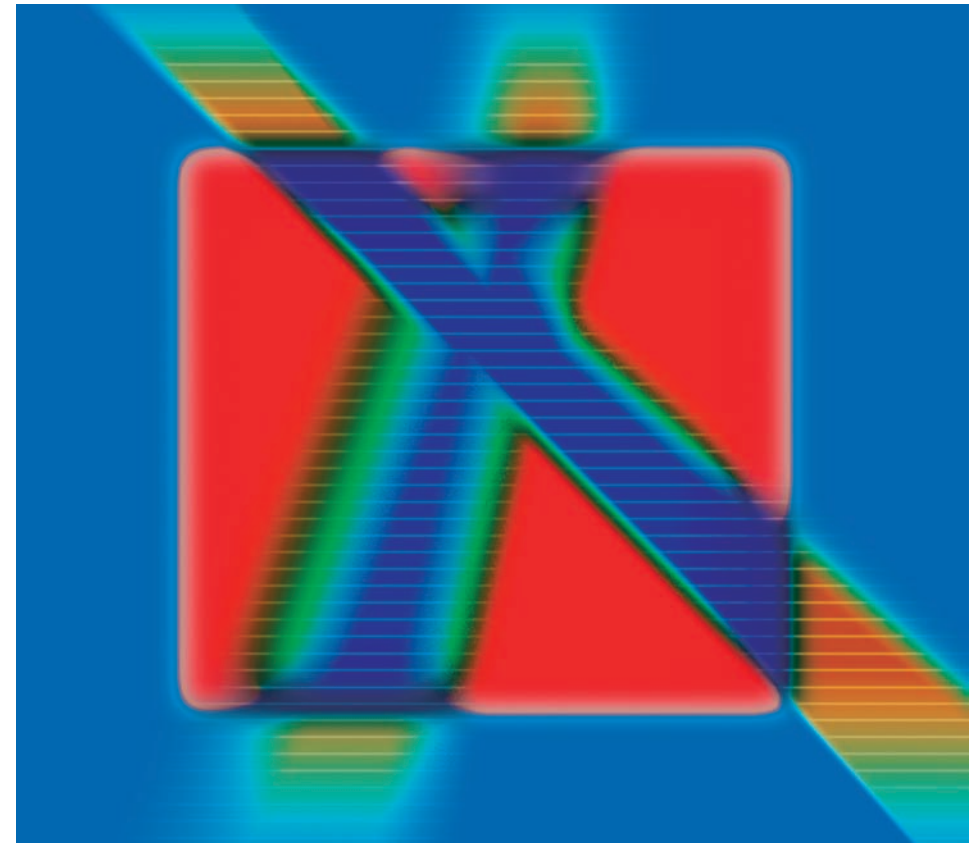



# Industrial Radiography Image forming techniques

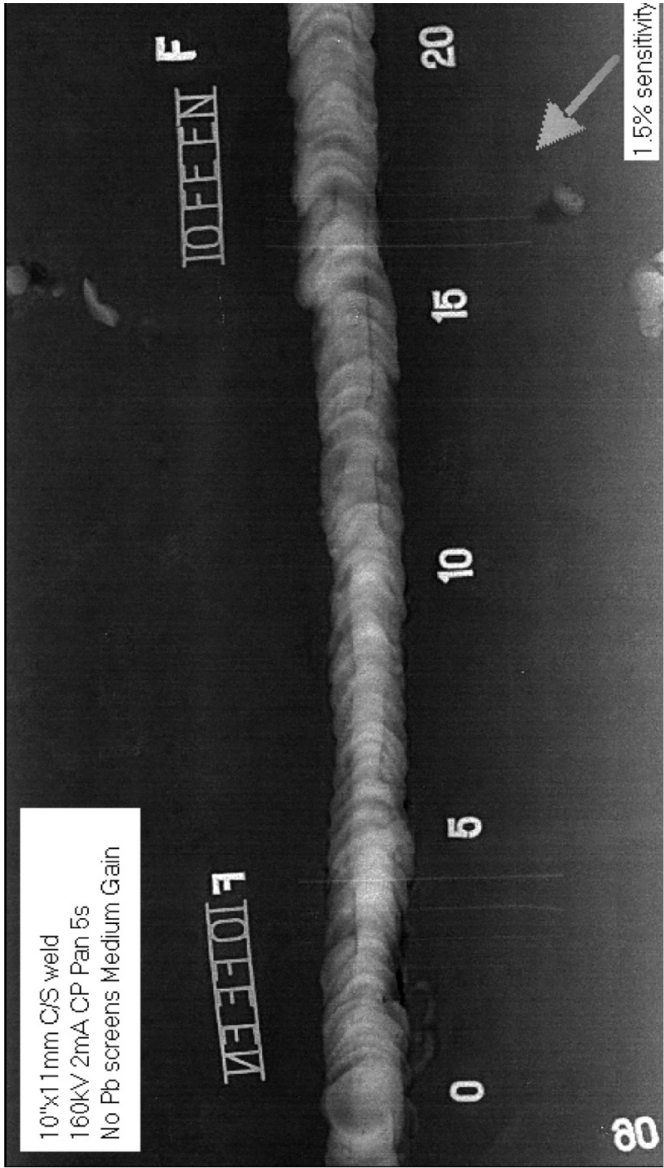

Digital radiography

CR-image of a weld  
see acknowledgements\*



# Introduction to the overview of “Industrial Radiography”

## Image forming techniques

*The first issue of “Industrial Radiography” was published by Agfa in the sixties, for educational and promotional purposes. Some improved editions have been released since, providing information on the latest image forming radiographic techniques. The booklet has been published in a number of languages and has been very much in demand. The latest edition was compiled in the seventies but is now obsolete, because of the large number of computer-aided NDT techniques which have entered the market in recent years.*

*In 2007 a new edition in the English language was published by GE Inspection Technologies. That edition was compiled by Mr. J.A. de Raad, NDT-expert and consultant, who has a considerable number of publications on the subject of Non-Destructive Testing to his name. Mr. A. Kuiper, an experienced specialist and tutor on industrial radiography, assisted him. Both had been involved in Non-Destructive Testing during their professional careers at Applus RTD NDT & Inspection headquartered in Rotterdam, the Netherlands.*

*Apart from the developments in conventional radiography, primarily regarding X-ray equipment and films, the 2007 issue describes the now mature methods of digital radiography using radiation-sensitive plate- and panel detectors, including digitisation of traditional film. Several other computer-assisted methods such as the CT technique are also included as well as a separate chapter describing a variety of applications.*

*In this latest 2008 edition we considerably extended the chapters on digital radiography and special techniques, such as microfocus and X-ray microscopy. In addition, the impact and (non) existence of norms, codes and standards on new NDT-technologies and their applications are addressed.*

*We trust that this new issue of “Industrial Radiography” will fulfil a need once again.*

**GE Inspection Technologies, 2008**

*The author expresses his appreciation to all employed by GE Inspection Technologies and Applus RTD NDT & Inspection who cooperated and provided ample information to update this new edition.*





# Contents

Introduction to the overview of “Industrial Radiography”

Image forming techniques

Preface 13

**1. Introduction to industrial radiography 15**

**2. Basic properties of ionising radiation 19**

2.1 Wavelengths of electromagnetic radiation 19

2.2 X-rays 20

2.3 Gamma-rays ( $\gamma$ -rays) 21

2.4 Main properties of X-rays and  $\gamma$ -rays 22

2.5 Radiation energy-hardness 22

2.6 Absorption and scattering 23

Photoelectric effect

Compton effect

Pair production

Total absorption/attenuation

2.7 Penetrating power 25

2.8 Filtering (hardening) 26

2.9 Half-value thickness 26

**3. Units and definitions 29**

3.1 Units 29

3.2 Definitions 30

Radioactivity

Ionisation dose rate

Ionisation dose

Absorbed energy dose

Equivalent dose (man dose)

**4. Radiation sources 33**

4.1 X-ray tube 33

4.2 The anode 33

Cooling the anode

The focal spot

Effective focal spot size

4.3 Tube voltage and tube current 35

4.4 Radioactive sources (isotopes) 36

Natural radioactive sources

Artificial radioactive sources

4.5 Advantages and disadvantages of artificial radioactive sources 36

4.6 Properties of radioactive sources 37

Activity (source strength)

Specific activity

Specific gamma-ray emission (k-factor)

Half-life of a radioactive source

**5. NDT equipment 39**

5.1 X-ray equipment 39

Types of X-ray tubes

Bipolar X-ray tubes

Unipolar X-ray tubes

Special types of X-ray tubes

5.2 High voltage generators 41

5.3 Megavolt equipment 42

The Bètatron

The linear accelerator (linac)

5.4 Radioactive sources 45

Average energy level (nominal value)

5.5 Source holders (capsules) 46

5.6 Transport- and exposure containers 46

5.7 Checking for container leakage 49

**6. Radiation images, filters and intensifying screens 51**

6.1 Radiation images 51

6.2 Radiation filters 53

6.3 Intensifying screens 53

Lead screens

Steel and copper screens

Fluorescent screens

Fluorescent salt screens

Fluorometallic screens

**7. The X-ray film and its properties 59**

7.1 Structure of the X-ray film 59

7.2 Radiographic image 59

Latent image

Developing the latent image

7.3 Characteristics of the X-ray film 60

Density (optical)

Contrast

7.4 Characteristic curve (density curve) 61



	Gradient of the density curve	
	Average gradient	
	Effect of developing conditions on the density curve	
7.5	Film speed (sensitivity)	65
7.6	Graininess	65
<b>8.</b>	<b>Film types and storage of films</b>	<b>67</b>
8.1	The Agfa assortment of film types	67
8.2	Film type selection	70
8.3	Film sizes	70
8.4	Handling and storage of unexposed films	70
<b>9.</b>	<b>Exposure chart</b>	<b>73</b>
9.1	Exposure chart parameters	73
	Type of X-ray equipment	
	The radioactive source	
	Source-to-film distance	
	Intensifying screens	
	Type of film	
	Density	
	Developing process	
9.2	Densitometer	75
9.3	Producing an exposure chart for X-rays	75
9.4	The exposure chart	78
9.5	Use of the exposure chart	78
9.6	Relative exposure factors	80
9.7	Absolute exposure times	80
9.8	Use of the characteristic (density) curve with an exposure chart	81
<b>10.</b>	<b>Processing and storage of X-ray films</b>	<b>85</b>
10.1	The darkroom	85
	Entrance and colour	
	Darkroom lighting	
	Darkroom layout	
	Tanks	
10.2	Chemicals and film-development	86
	Making-up processing solutions	
	Developer	
	Fixer	
	Developing time and bath temperatures	
	Film agitation	
	Replenishing	

	Stopbath	
	Fixing	
	Final wash	
	Drying in the drying cabinet	
	Roller dryers	
10.3	Recommendations for the darkroom	90
10.4	Silver recovery	90
10.5	Automatic film processing	91
	NDT-U (universal) film processor	
	NDT-E (economy) film processor	
10.6	Checking the developing process and film archiving properties	93
	PMC-strips to check the developing process	
	Thiosulphate-test to check the film archival properties	
10.7	Storage of exposed films	95
<b>11.</b>	<b>Defect discernibility and image quality</b>	<b>97</b>
11.1	Unsharpness	97
	Geometric unsharpness	
	Inherent (film) unsharpness	
	Total unsharpness	
11.2	Selection source-to-film distance	101
11.3	Other considerations with regard to the source-to-film distance	102
	Inverse square law	
	Selection of radiation energy (kV)	
	Selection of gamma source	
11.4	Radiation hardness and film contrast	104
11.5	Summary of factors that influence the image quality	105
<b>12.</b>	<b>Defect orientation, image distortion and useful film length</b>	<b>107</b>
12.1	Defect detectability and image distortion	107
12.2	Useful film length	108
<b>13.</b>	<b>Image quality</b>	<b>111</b>
13.1	Factors influencing image quality	111
13.2	Image quality indicators (IQI)	112
	Wire type IQI according to EN 462-1	
13.3	List of common IQI's	114
	ASTM IQI's	
	AFNOR IQI's	
	Duplex IQI's	
13.4	Position of the IQI	117
13.5	IQI sensitivity values	117
<b>14.</b>	<b>Film exposure and handling errors</b>	<b>119</b>





<b>15.</b>	<b>Film interpretation and reference radiographs</b>	<b>123</b>
15.1	Film interpretation	123
15.2	The film-interpreter	124
15.3	Reference radiographs	124
	Weld inspection	
	Casting radiography	
	Examination of assembled objects	
<b>16.</b>	<b>Digital Radiography (DR)</b>	<b>145</b>
16.1	Introduction to DR	145
16.2	Digital image formation	146
16.3	Digitisation of traditional radiographs	146
16.4	Computed Radiography (CR)	148
	Two-step digital radiography	
	The CR imaging plate	
	Image development	
	Scanners-Readers	
	CR cassettes	
	Dynamic range-Exposure latitude	
	Exposure time and noise	
	Fading	
	Optimisation	
	Improvements	
16.5	Genuine Digital Radiography (DR)	153
	One-step digital radiography	
16.5.1	Detector types	153
	Direct versus indirect detection	
	Linear detectors	
	2D detectors	
16.5.2	Fill Factor	155
16.5.3	Flat panel and flat bed detector systems	156
	Amorphous silicon flat panels	
	CMOS detectors and flat bed scanners	
	Limitations	
16.6	Image quality and exposure energy	158
16.6.1	Exposure energy	158
16.6.2	Determination of image quality	159
16.6.3	Indicators of image quality- MTF and DQE	160
	Factors influencing image quality	
	Image quality definitions	
	Exposure parameters	
	MTF (Modulation Transfer Function)	
	DQE (Defective Quantum Efficiency)	
	Noise, image averaging and DQE	

16.7	Resolution number of bits	163
	Bit depth	
	Lateral resolution	
16.8	Comparison of film, CR- and DR methods	164
16.9	Impact and status of CR- and DR standards	165
	Development of standards	
	Status of CR standards	
	Status of DR standards	
	Impact of standards	
	Standards for weld inspection	
	Data exchange and tamper proof standard	
16.10	Selection of CR- and DR methods	167
16.11	Applications for CR- and DR methods	168
	Corrosion detection	
	Weld inspection	
	Dose reduction and controlled area	
	Automated/mechanised inspection	
	Girth weld inspection	
	Useful life of plate and panel	
16.12	Work station	171
	Hardware and software	
	Versatility of the software	
	Archiving and reliability of images	
	Exchange of data	
<b>17.</b>	<b>Special radiographic techniques</b>	<b>177</b>
17.1	Image magnification techniques	177
17.1.1	Common image magnification technique	177
17.1.2	High resolution X-ray microscopy	178
	Magnification factors	
	Microfocus and nanofocus X-ray tubes	
	Tube heads	
	System set-up	
	Effect of focal dimensions	
	Imaging systems for high resolution radiography	
17.2	Fluoroscopy, real-time image intensifiers	182
	Stationary real-time installations	
	Portable real-time equipment	
17.3	Computer Tomography (CT)	185
	Unique features	
	Computing capacity and scanning time	
	Reverse engineering	
	CT metrology	
	High resolution and defect sizing	



17.4	CT for defect detection and sizing Effect of defect orientation 3D CT for sizing of defects in (welded) components	187
17.5	Neutron radiography (neutrography)	190
17.6	Compton backscatter technique	190
<b>18.</b>	<b>Special radiographic applications</b>	<b>193</b>
18.1	Measuring the effective focal spot	193
18.2	Radiographs of objects of varying wall thickness	194
18.3	Radiography of welds in small diameter pipes Elliptical technique Perpendicular technique	195
18.4	Determining the depth position of a defect	197
18.5	Determining the depth position and diameter of reinforcement steel in concrete	198
18.6	On-stream inspection - profiling technique Projection technique Tangential technique Selection of source, screens and filters Exposure time	198
18.7	Flash radiography	201
18.8	Radiography of welds in large diameter pipes	202
<b>19.</b>	<b>Radiation hazards, measuring- and recording instruments</b>	<b>207</b>
19.1	The effects of radiation on the human body 179	207
19.2	Responsibilities The client The radiographer	207
19.3	The effects of exposure to radiation	208
19.4	Protection against radiation	208
19.5	Permissible cumulative dose of radiation	209
19.6	Radiation measurement and recording instruments Radiation measuring instruments Dose rate meters Scintillation counter Personal protection equipment Podosimeter (PDM) Thermoluminescent dose meter (TLD-badge) Film dose meter (film-badge)	210
19.7	Dose registration	212
19.8	Radiation shielding Distance Absorbing barrier and distance	212

## **20. Standards, literature / references, acknowledgements and appendices 215**

European norms (EN-standards)  
Literature and references  
Acknowledgements  
Appendices: tables and graphs.





## Preface

To verify the quality of a product, samples are taken for examination or a non-destructive test (NDT) is carried out. In particular with fabricated (welded) assemblies, where a high degree of constructional skill is needed, it is necessary that non-destructive testing is carried out.

Most NDT systems are designed to reveal defects, after which a decision is made as to whether the defect is significant from the point of view of operational safety and/or reliability. Acceptance criteria for weld defects in new constructions have been specified in standards.

However, NDT is also used for purposes such as the checking of assembled parts, the development of manufacturing processes, the detection of corrosion or other forms of deterioration during maintenance inspections of process installations and in research.

There are many methods of NDT, but only a few of these allow the full examination of a component. Most only reveal surface-breaking defects.

One of the longest established and widely used NDT methods for volumetric examination is radiography: the use of X-rays or gamma-rays to produce a radiographic image of an object showing differences in thickness, defects (internal and surface), changes in structure, assembly details etc. Presently, a wide range of industrial radiographic equipment, image forming techniques and examination methods are available. Skill and experience are needed to select the most appropriate method for a particular application. The ultimate choice will be based on various factors such as the location of the object to be examined, the size and manoeuvrability of the NDT equipment, the existence of standards and procedures, the image quality required, the time available for inspection and last but not least financial considerations.

This book gives an overview to conventional industrial radiography, as well as digital (computer-aided) techniques and indicates the factors which need to be considered for selection of the most suitable system and procedures to be followed.

At the end of the book a chapter is added describing aspects of radiation safety.





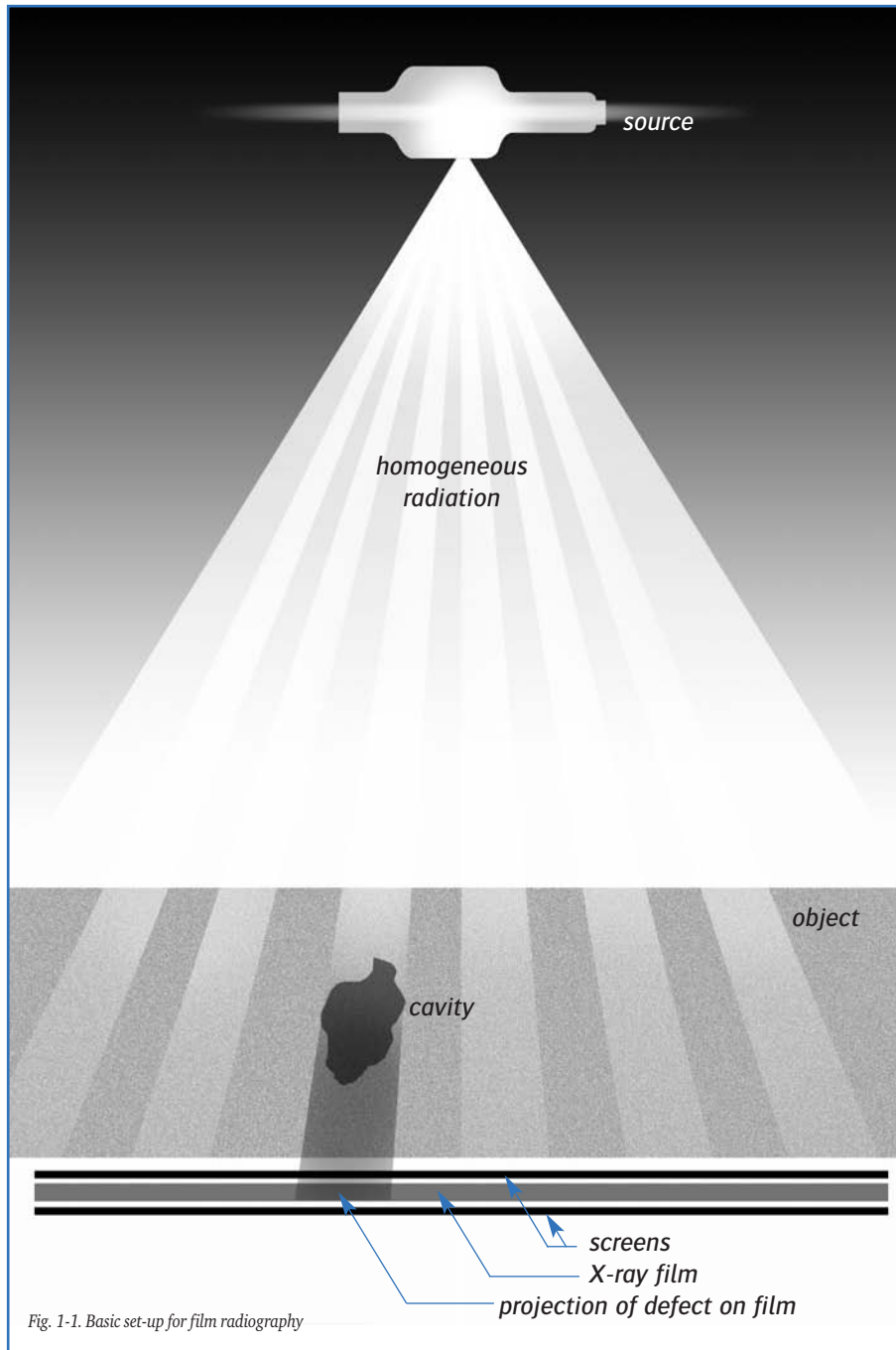

Fig. 1-1. Basic set-up for film radiography

## 1 Introduction to industrial radiography Image forming techniques

In industrial radiography, the usual procedure for producing a radiograph is to have a source of penetrating (ionising) radiation (X-rays or gamma-rays) on one side of the object to be examined and a detector of the radiation (the film) on the other side as shown in figure 1-1. The energy level of the radiation must be well chosen so that sufficient radiation is transmitted through the object onto the detector.

The detector is usually a sheet of photographic film, held in a light-tight envelope or cassette having a very thin front surface that allows the X-rays to pass through easily. Chemicals are needed to develop the image on film, which is why this process is called the classic or “wet” process.

Nowadays, different kinds of radiation-sensitive films and detectors not requiring the use of chemicals to produce images, the so-called “dry” process, are used increasingly. These techniques make use of computers, hence the expressions; digital or computer aided radiography (CR) or genuine (true) digital radiography (DR), see chapter 16.

A DR related technique that has been available for many decades is the one in which images are formed directly with the aid of (once computerless) radiation detectors in combination with monitor screens (visual display units: VDU's), see chapter 17. This is in fact is an early version of DR.

These through transmission scanning techniques (known as fluoroscopy) the storage of images and image enhancement are continually improved by the gradual implementation of computer technology. Nowadays, there is no longer a clear division between conventional fluoroscopy with the aid of computers and the entirely computer-aided DR. In time DR will, to some extent, replace conventional fluoroscopy.

Summarising, the image of radiation intensities transmitted through the component can be recorded on:

The conventional X-ray film with chemical development, the “wet” process, or one of the following “dry” processes:

- A film with memory phosphors and a work station for digital radiography, called computer-assisted radiography or CR.
- Flat panel and flat bed detectors and a computer work station for direct radiography, called DR.
- A phosphorescent or fluorescent screen (or similar radiation sensitive medium) and a closed-circuit television (CCTV) camera as in conventional fluoroscopy, an early version of direct radiography.



- By means of radiation detectors, e.g.: crystals, photodiodes or semiconductors in a linear array by which in a series of measurements an image is built up of a moving object. This method is applied in systems for luggage checks on airports.

The source of radiation should be physically small (a few millimetres in diameter), and as X-rays travel in straight lines from the source through the specimen to the film, a sharp “image” is formed of the specimen and discontinuities. This geometric image formation is identical to the shadow image with a visible light source. The sharpness of the image depends, in the same way, on the radiation source diameter and its distance away from the surface on which the image is formed.

The “classic” film in its light-tight cassette (plastic or paper) is usually placed close behind the specimen and the X-rays are switched on for an appropriate time (the exposure time) after which the film is taken away and processed photographically, i.e. developed, fixed, washed and dried. In direct radiography (DR), a coherent image is formed directly by means of an computerised developing station.

The two methods have a negative image in common. Areas where less material (less absorption) allows more X-rays to be transmitted to the film or detector will cause increased density. Although there is a difference how the images are formed, the interpretation of the images can be done in exactly the same way. As a result, the DR- technique is readily accepted.

The “classic” film can be viewed after photochemical treatment (wet process) on a film viewing screen. Defects or irregularities in the object cause variations in film density (brightness or transparency). The parts of the films which have received more radiation during exposure – the regions under cavities, for example – appear darker, that is, the film density is higher. Digital radiography gives the same shades of black and white images, but viewing and interpretation is done on a computer screen (VDU).

The quality of the image on the film can be assessed by three factors, namely :

1. Contrast
2. Sharpness
3. Graininess

As an example, consider a specimen having a series of grooves of different depths machined in the surface. The density difference between the image of a groove and the background density on the radiograph is called the image contrast. A certain minimum image contrast is required for the groove to become discernible.

With increased contrast:

- a. the image of a groove becomes more easily visible
- b. the image of shallower grooves will gradually also become discernible

Assuming the grooves have sharp-machined edges, the images of the grooves could still be either sharp or blurred; this is the second factor: image blurring, called image unsharpness.

At the limits of image detection it can be shown that contrast and unsharpness are inter-related and detectability depends on both factors.

As an image on a photographic film is made up of grains of silver, it has a grainy appearance, dependent on the size and distribution of these silver particles. This granular appearance of the image, called film graininess, can also mask fine details in the image.

Similarly, in all other image forming systems these three factors are fundamental parameters. In electronic image formation, e.g. digital radiography or scanning systems with CCTV and screens, the factors contrast, sharpness and noise are a measure for the image quality; pixel size and noise being the (electronic) equivalent of graininess .

The three factors: contrast, sharpness and graininess or noise are the fundamental parameters that determine the radiographic image quality. Much of the technique in making a satisfactory radiograph is related to them and they have an effect on the detectability of defects in a specimen.

The ability of a radiograph to show detail in the image is called “radiographic sensitivity”. If very small defects can be shown, the radiographic image is said to have a high (good) sensitivity. Usually this sensitivity is measured with artificial “defects” such as wires or drilled holes. These image quality indicators (IQIs) are described in chapter 13.



## 2 Basic properties of ionising radiation

In 1895 the physicist Wilhelm Conrad Röntgen discovered a new kind of radiation, which he called X-rays. The rays were generated when high energy electrons were suddenly stopped by striking a metal target inside a vacuum tube – the X-ray tube. It was subsequently shown that X-rays are an electromagnetic radiation, just like light, heat and radiowaves.

### 2.1 Wavelengths of electromagnetic radiation

The wavelength  $\lambda$  of electromagnetic radiation is expressed in m, cm, mm, micrometer ( $\mu\text{m}$ ), nanometer (nm) and Ångstrom ( $1 \text{ \AA} = 0.1 \text{ nm}$ ).

Electromagnetic radiation	Wavelength $\lambda$	m	Type	
	10 km	$10^4$		
	1 km	$10^3$		
	100 m	$10^2$		
	10 m	$10^1$		
	1 m	1		
	10 cm	$10^{-1}$		
	1 cm	$10^{-2}$		
	1 mm	$10^{-3}$		
	100 $\mu\text{m}$	$10^{-4}$		
	10 $\mu\text{m}$	$10^{-5}$		Heat-rays, Infra-red rays, microwaves
	1 $\mu\text{m}$	$10^{-6}$		
X-ray energy	100 nm	$10^{-7}$	Visible light and Ultraviolet (UV)	
100 eV	10 nm	$10^{-8}$		
1 keV	1 nm	$10^{-9}$	X-rays and Gamma-rays (Radiography)	
10 keV	0.1 nm	$10^{-10}$		
100 keV	0.01 nm	$10^{-11}$		
1 MeV	1 pm	$10^{-12}$		
10 MeV	0.1 pm	$10^{-13}$		
100 MeV	0.01 pm	$10^{-14}$		

Table 1-2. Overview of wavelength, energy and type of electromagnetic radiation



## 2.2 X-rays

The radiation which is emitted by an X-ray tube is heterogeneous, that is, it contains X-rays of a number of wavelengths, in the form of a continuous spectrum with some superimposed spectrum lines.

See fig. 1-2.

The shortest wavelength of the spectrum is given by the Duane-Hunt formula:

$$\lambda_{\min} = \frac{1.234}{\text{kV}}$$

In which :

$\lambda$  = wavelength in nanometers ( $10^{-9}\text{m}$ )  
 kV = voltage in kilovolts

The average shape of the X-ray spectrum is generally the same however not truly identical for different X-ray sets; it depends chiefly on the energy range of the electrons striking the X-ray tube target and, therefore, on the voltage waveform of the high-voltage generator. A constant potential (CP) X-ray set will not have the same spectrum as a self-rectified set operating at the same nominal kV and current. The spectrum shape also depends on the inherent filtration in the X-ray tube window (glass, aluminium, steel or beryllium).

The energy imparted to an electron having a charge  $e$ , accelerated by an electrical potential  $V$  is (eV) so the energy of the electrons can be quoted in eV, keV, MeV. These same units are used to denote the energy of an X-ray spectrum line.

The energy of a single wavelength is :

$$E = h \cdot \nu \quad \lambda \cdot \nu = c$$

In which:

$E$  = the energy in electronVolt (eV)

$h$  = Planck's constant

$\nu$  = frequency

$c$  = the velocity of electromagnetic radiation, such as light (300,000 km/s)

The heterogeneous X-rays emitted by an X-ray tube do not however have a single wavelength, but a spectrum, so it would be misleading to describe the X-rays as (say) 120 keV X-rays. By convention therefore, the 'e' in keV- is omitted and the X-rays described as 120 kV, which is the peak value of the spectrum.

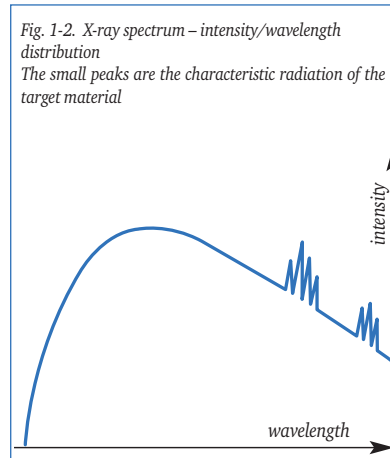

## 2.3 Gamma-rays ( $\gamma$ -rays)

Radioactivity is the characteristic of certain elements to emit alpha ( $\alpha$ ), beta ( $\beta$ ) or gamma ( $\gamma$ ) rays or a combination thereof. Alpha and beta rays consist of electrically charged particles, whereas gamma rays are of an electromagnetic nature.

Gamma rays arise from the disintegration of atomic nuclei within some radioactive substances, also known as isotopes. The energy of gamma-radiation cannot be controlled; it depends upon the nature of the radioactive substance. Nor is it possible to control its intensity, since it is impossible to alter the rate of disintegration of a radioactive substance.

Unlike X-rays, generated to a continuous spectrum, Gamma-rays are emitted in an isolated line spectrum, i.e. with one or more discrete energies of different intensities.

Figure 2-2 shows the energy spectrum lines for Selenium75, Cobalt60 and Iridium192. In practical NDT applications, sources (radio active isotopes) are allocated an average nominal energy value for calculation purposes, see section 5.4. Spectrum components with the highest energy levels (keV values) influence radiographic quality the most.

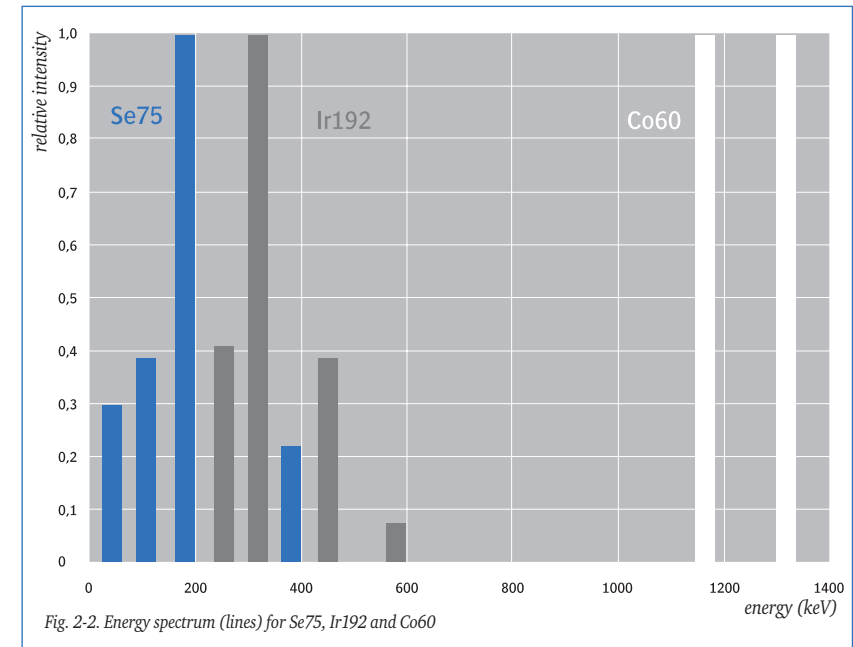

## 2.4 Main properties of X-rays and $\gamma$ -rays

X-rays and  $\gamma$ -rays have the following properties in common:

1. invisibility; they cannot be perceived by the senses
2. they travel in straight lines and at the speed of light
3. they cannot be deflected by means of a lens or prism, although their path can be bent (diffracted) by a crystalline grid
4. they can pass through matter and are partly absorbed in transmission
5. they are ionising, that is, they liberate electrons in matter
6. they can impair or destroy living cells

## 2.5 Radiation energy-hardness

Radiation hardness (beam quality) depends on wavelength. Radiation is called hard when its wavelength is small and soft when its wavelength is long. In industry the quality of the X-ray tube ranges from very soft to ultra hard. The beam quality is related to a tube voltage (kV) range, or keV for isotopes.

The first two columns of table 2-2 below indicate the relationship hardness/tube voltage range applied in NDT. The third column gives the related qualification of the radiation effect, i.e. half-value thickness (HVT), described in detail in section 2.9.

Radiation quality Hardness	Tube voltage	Global half-value thickness for steel (mm)
Very soft	Less than 20 kV	
Soft	20 – 60 kV	
Fairly soft	60 – 150 kV	0.5-2
Hard	150 – 300 kV	2-7
Very hard	300 – 3000 kV	7-20
Ultra hard	more than 3000 kV	> 20

Table 2-2. Comparative values of radiation quality (hardness) against tube voltage.

## 2.6 Absorption and scattering

The reduction in radiation intensity on penetrating a material is determined by the following reactions :

1. Photoelectric effect
2. Compton effect
3. Pair production

Which of these reactions will predominate depends on the energy of the incident radiation and the material irradiated.

### Photoelectric effect

When X-rays of relatively low energy pass through a material and a photon collides with an atom of this material, the total energy of this photon can be used to eject an electron from the inner shells of the atom, as figure 3-2 illustrates. This phenomenon is called the photoelectric effect and occurs in the object, in the film and in any filters used.

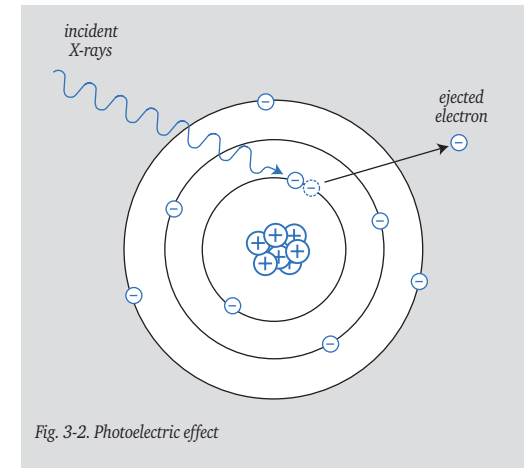

Fig. 3-2. Photoelectric effect

### Compton effect

With higher X-ray energies (100 keV to 10 MeV), the interaction of photons with free or weakly bonded electrons of the outer atom layers causes part of the energy to be transferred to these electrons which are then ejected, as illustrated in figure 4-2. At the same time the photons will be deflected from the initial angle of incidence and emerge from the collision as radiation of reduced energy, scattered in all directions including backward, known as “backscatter”, see section 17.6. In this energy band, the absorption of radiation is mainly due to the Compton effect and less so to the photoelectric effect.

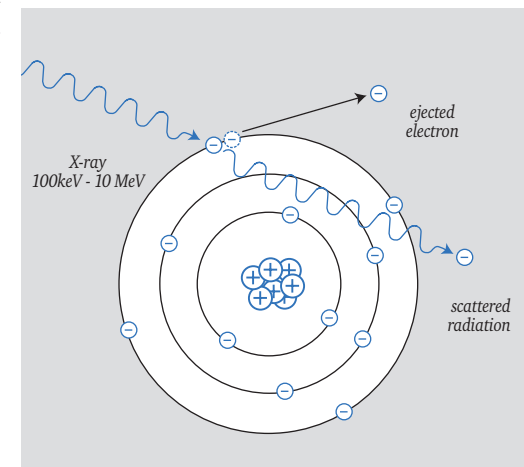

Fig. 4-2. Compton effect



### Pair production

The formation of ion pairs, see figure 5-2, only occurs at very high energy levels (above 1 MeV). High-energy photons can cause an interaction with the nucleus of the atom involved in the collision. The energy of the photon is here converted to an electron (e-) and a positron (e+).

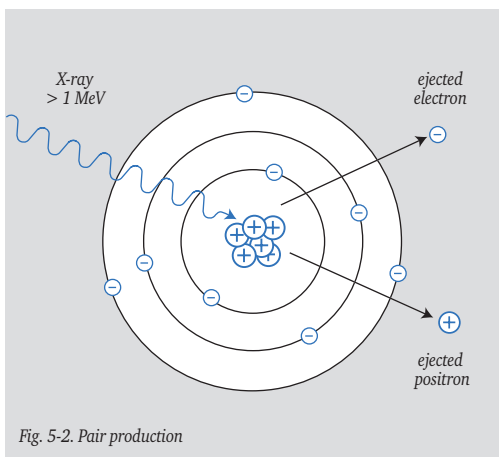

Fig. 5-2. Pair production

### Total absorption/attenuation

The total linear absorption or attenuation of X-rays is a combination of the three absorption processes described above, in which the primary X-ray energy changes to a lower form of energy. Secondary X-ray energy arises of a different wavelength and a different direction of travel. Some of this secondary (scattered) radiation does not contribute to radiographic image forming and may cause loss of image quality through blurring or fog. The contribution of the various causes of X-ray absorption to the total linear absorption coefficient ( $\mu$ ) for steel plotted against radiation energy, are shown in figure 6-2.

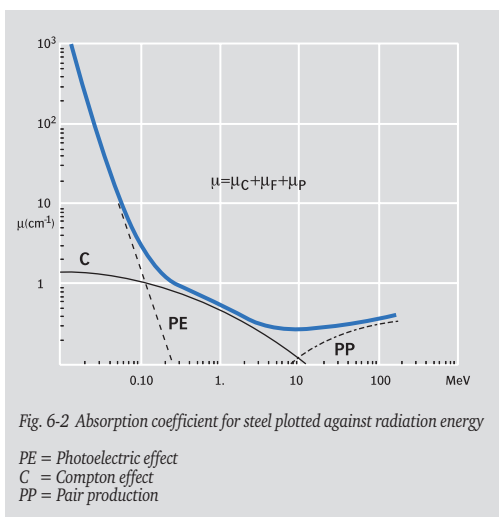

Fig. 6-2 Absorption coefficient for steel plotted against radiation energy

PE = Photoelectric effect  
C = Compton effect  
PP = Pair production

### 2.7 Penetrating power

The penetrating power of X-radiation increases with the energy (hardness). The relationship of energy and penetrating power is complex as a result of the various mechanisms that cause radiation absorption. When monochromatic (homogeneous - single wave length) radiation with an intensity  $I_0$  passes through matter, the relative intensity reduction  $\Delta I/I_0$  is proportional to the thickness  $\Delta t$ . The total linear absorption coefficient ( $\mu$ ) consisting of the three components described in section 2.6 is defined by the following formula:

$$\frac{\Delta I}{I_0} = \mu \cdot \Delta t$$

Expressed differently:

$$I = I_0 \cdot e^{-\mu t}$$

In which:

$I_0$  = intensity at material entry       $t$  = thickness  
 $I$  = intensity at material exit       $e$  = logarithm: 2.718  
 $\mu$  = total absorption coefficient

Figure 7-2 shows the resulting radiation intensity (logarithmic) as a function of increased material thickness, for soft and hard **homogeneous** radiation.

When radiation is **heterogeneous** the graphs are not straight, see figure 7-2, but slightly curved as in figure 8-2.

The slope of the curves becomes gradually shallower (because of selective absorption of the softer radiation) until it reaches the so-called "point-of-homogeneity". After passing this point the coefficient of absorption remains virtually unchanged, as if the radiation had become homogeneous.

The position of the point of homogeneity varies with the nature of the material irradiated. The graph shows that with increasing material thickness, softer radiation is filtered out, more than hard radiation. This effect is called "hardening".

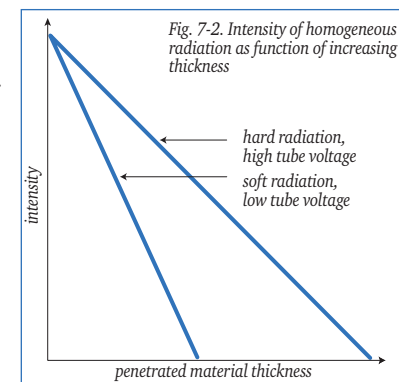

Fig. 7-2. Intensity of homogeneous radiation as function of increasing thickness

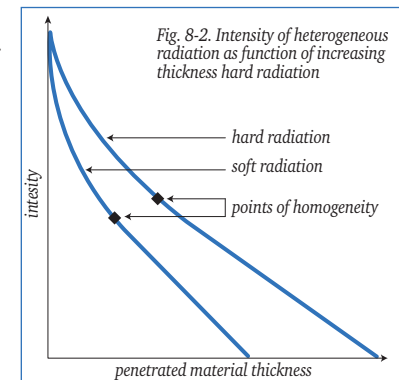

Fig. 8-2. Intensity of heterogeneous radiation as function of increasing thickness hard radiation





## 2.8 Filtering (hardening)

All materials, for example a metal layer between the radiation source and the film, cause absorption and filtering. The position of the metal layer plays an important role in the effect it has. A metal layer in front of the object will “harden” the radiation because it filters out the soft radiation. The degree of hardening depends on the type and the thickness of the material. This phenomenon is used to reduce excessive contrast (variation in density) when examining objects of which the thickness varies greatly.

A metal layer between the object and the film filters the soft scattered radiation that occurs in the object, thereby increasing the contrast and consequently the image quality. This method of filtering is for example applied in the use of Cobalt60 in combination with exposure time reducing intensifying screens, which are sensitive to scattered radiation. Lead, copper and steel are suitable filtering materials.

## 2.9 Half-value thickness

A convenient practical notion (number) of the linear absorption coefficient is the introduction of the half-value thickness (HVT). It quantifies the penetrating power of radiation for a particular type of material and is defined as the thickness of a particular material necessary to reduce the intensity of a monochromatic beam of radiation by half, as shown in figure 9-2. This HVT-value depends on the hardness of radiation.

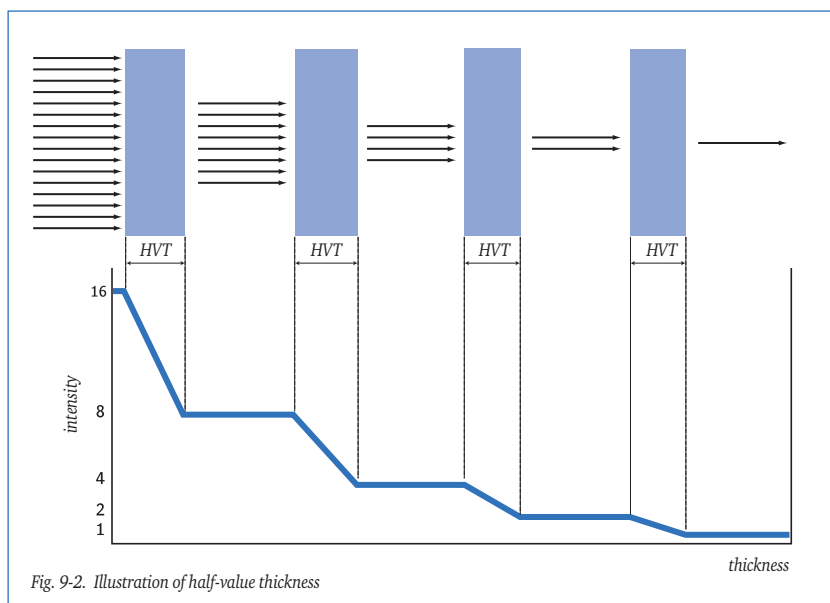

Table 2-2 shows the average HVT-values for steel, table 3-2 shows the values for lead.

Element/Isotope	Symbol	Average energy level in MeV	Half-value thickness in mm lead
Ceasium137	Cs137	0.66	8.4
Cobalt60	Co60	1.25	13
Iridium192	Ir192	0.45	2.8
Selenium75	Se75	0.32	2
Ytterbium169	Yb169	0.2	1
Thulium170	Tm170	0.072	0.6

Table 3-2. Half-value thickness for lead

For a heterogeneous beam the HVT is not constant; the second HVT is slightly larger than the first. In general, in industry where relatively hard radiation is used, a fixed “average” HVT is applied.



## 3 Units and definitions

### 3.1 Units

Until 1978 the “International Commission of Radiation Units and Measurements” (ICRU) used the conventional radiation units of roentgen (R), rad (rd), and curie (Ci). Since 1978 the ICRU has recommended the use of the international system units (SI) with special new units for radiation quantities; the Becquerel, Gray and Sievert.

Table 1-3 shows the relationships of these new units to the older units.

Designation of quantity	SI-units		Formerly used		Conversion
	Name	Unit Designation	Name	Unit Designation	Old to SI
Activity (A)	Becquerel (Bq)	1/s*	Curie	Ci	1 Ci = 37 GBq
Ionisation dose	Coulomb (C)	C/kg	Röntgen	R	1 R = 2.58 x 10 <sup>-4</sup> C/kg
Ionisation dose rate	Coulomb (C) Ampère (A)	C/kg.s or A/kg		R/s	
Absorbed energy dose (D)	Gray (Gy)	J/kg	Rad	Rad	1 Rad = 0.01 Gy
Equivalent dose (H) H = D x RBE**	Sievert (Sv)	J/kg	Rem	Rem	1 Rem = 0.01 Sv

Table 1-3. Overview of new and old units

\* disintegrations per second

C = Coulomb = A.s

J = Joule

\*\* RBE = Relative Biological Effect

A = Ampère

In radiography and radiation safety, units are preceded by prefixes.

Table 2-3 shows the ones mostly used.

Prefix	Meaning	Value	Notation
p	pico	0.000000000001	10 <sup>-12</sup>
n	nano	0.000000001	10 <sup>-9</sup>
μ	micro	0.000001	10 <sup>-6</sup>
m	milli	0.001	10 <sup>-3</sup>
-	1	1	1
k	kilo	1000	10 <sup>3</sup>
M	Mega	1000000	10 <sup>6</sup>
G	Giga	1000000000	10 <sup>9</sup>

Table 2-3. Prefixes



## 3.2 Definitions

---

### Radioactivity

The activity of a radioactive source of radiation (isotope) is equal to the number of disintegrations per second. The SI-unit is the Becquerel (Bq) and is equal to 1 disintegration per second. The Becquerel is too small a unit to be used in industrial radiography. Source strengths are, therefore, quoted in Giga Becquerel (GBq).

1 Curie = 37 GBq, see table 2-3.

### Ionisation dose rate

The output of an X-ray set or isotope per unit of time is generally quoted at one metre distance from the source, and designated in C/kg, see table 1-3.

### Ionisation dose

The ionising effect of radiation in one kilogram of dry air is used to define the ionisation dose. The dose of radiation delivered is equal to the ionisation dose rate multiplied by the amount of time during which radiation takes place.

The designation used is C/kg.sec.

The output of an X-ray set, however, is quoted in Sievert per hour, measured at 1 metre distance.

### Absorbed energy dose

The radiation energy that is absorbed is expressed in Joules per kilogram (J/kg).

The SI-unit is called Gray (Gy) whereby  $1 \text{ J/kg} = 1 \text{ Gy}$ .

### Equivalent dose (man dose)

The Sievert (Sv) is the SI-unit for the biological effect of ionising radiation upon man. It corresponds with the product of the absorbed energy dose gray (Gy) with a factor that has been experimentally determined and that indicates the relative biological effect (RBE) of the ionising radiation. For X- and  $\gamma$ -radiation this factor is equal to one, so that the Sievert is equal to the Gray.



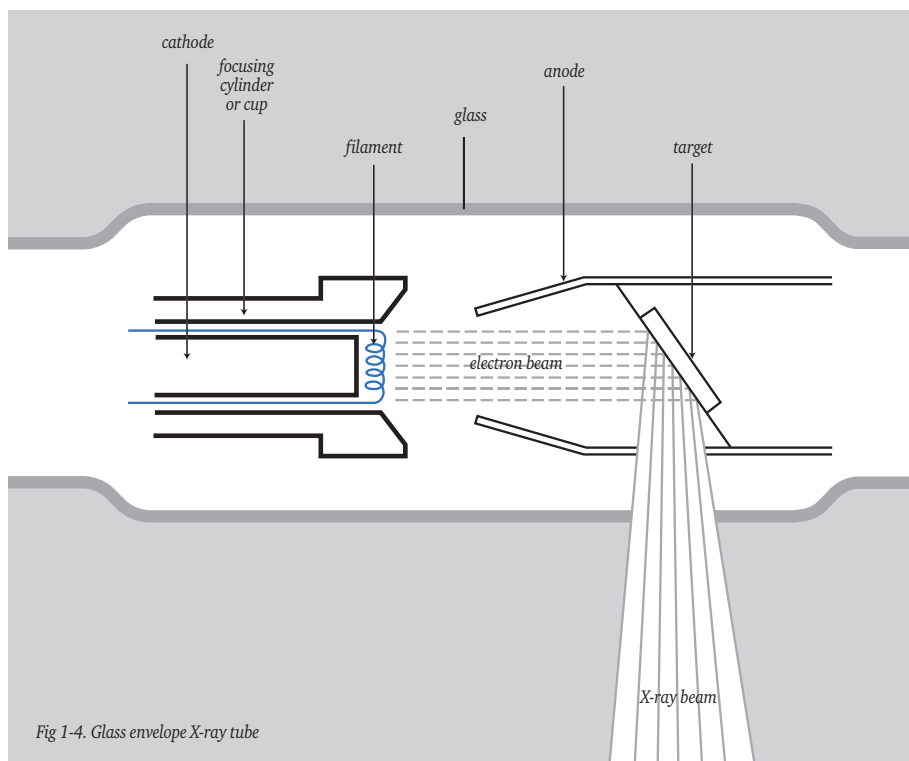
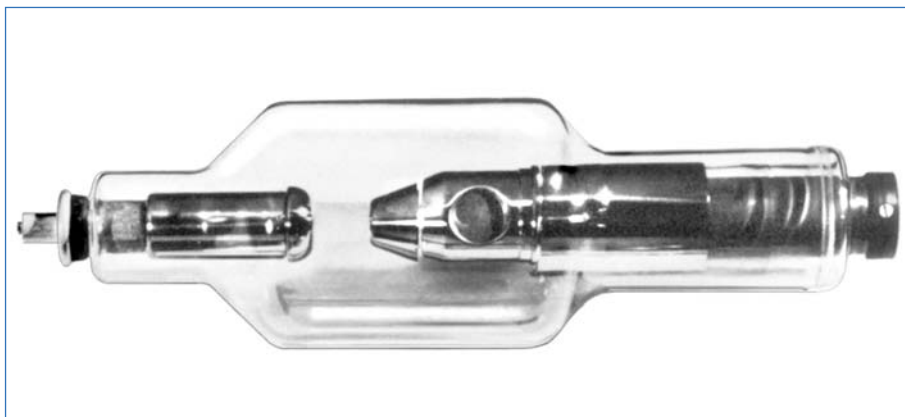

Fig 1-4. Glass envelope X-ray tube

## 4

## Radiation sources

### 4.1 X-Ray tube

The X-ray tube, see figure 1-4, consists of a glass (or ceramic) envelope containing a positive electrode (the anode) and a negative electrode (the cathode) evacuated to an ultra high vacuum [ $10^{-9}$  hPa (hectoPascal)].

The cathode comprises a filament that generates electrons. Under the effect of the electrical tension set up between the anode and the cathode (the tube voltage) the electrons from the cathode are attracted to the anode, which accelerates their speed.

This stream of electrons is concentrated into a beam by a “cylinder” or “focusing cup”. When the accelerated electrons collide with a target on the anode, part of their energy is converted to X-radiation, known as X-rays.

### 4.2 The anode

The target is generally made of tungsten. Not only because it has a high atomic number, but also because of its high melting point (approx.  $3400^{\circ}\text{C}$ ). It is essential to use a material with a high melting point because of the substantial amount of heat dissipated as the electron-“bombardment” is concentrated (focused) on a very small surface. Only a part (approx. 0.1 % at 30 keV; 1 % at 200 keV; 40 % at 30 to 40 MeV) of the kinetic energy of the electrons is converted into X-radiation; the remainder is transformed into heat.

#### Cooling the anode

The heat which accompanies the production of X-radiation is quite considerable, so that the anode has to be cooled. This can be done in a variety of ways :

1. by natural radiation
2. by convection
3. by forced circulation of liquid or gas
4. by conduction

#### The focal spot

The area of the target which is struck by the electrons, see figure 2-4, is called the focal spot or “the focus”. It is essential that this area is sufficiently large to avoid local overheating, which might damage the anode.

From the radiographic point of view, however, the focus has to be as small as possible in order to achieve maximum sharpness in the radiographic image. This “focal loading” is expressed in Joule/ $\text{mm}^2$ . A tungsten target can take a maximum loading of 200 Joule/ $\text{mm}^2$ . A higher loading might damage the anode.



### Effective focal spot size

The projections of the focal spot on a surface perpendicular to the axis of the beam of X-rays is termed the “effective focal spot size” or “focus size”, see figure 2-4. The effective focus size is one of the parameters in radiography, see section 11-1. The effective focus size, principally determining the sharpness in the radiographic image, has to be as small as possible in order to achieve maximum sharpness. The dimensions of the focus are governed by:

1. The size of the focal spot, and
2. The value of angle  $\alpha$ , see figure 2-4.

It should be noted that when in radiography we speak of the “size of the focus” without specifying this more exactly, it is normally the effective focal spot size which is meant. Conventional X-ray tubes have effective focal spot sizes in the range 4 x 4 mm to 1 x 1 mm. There are fine-focus tubes with focal spots from 0.5 x 0.5 mm and microfocus tubes down to 50  $\mu\text{m}$  diameter or even much less, known as nanofocus tubes.

The effective focal spot size can be determined in accordance with the procedures described in EN 12543 replacing the old IEC 336 which however is still in use. For more information on focal spot measurement see section 18.1.

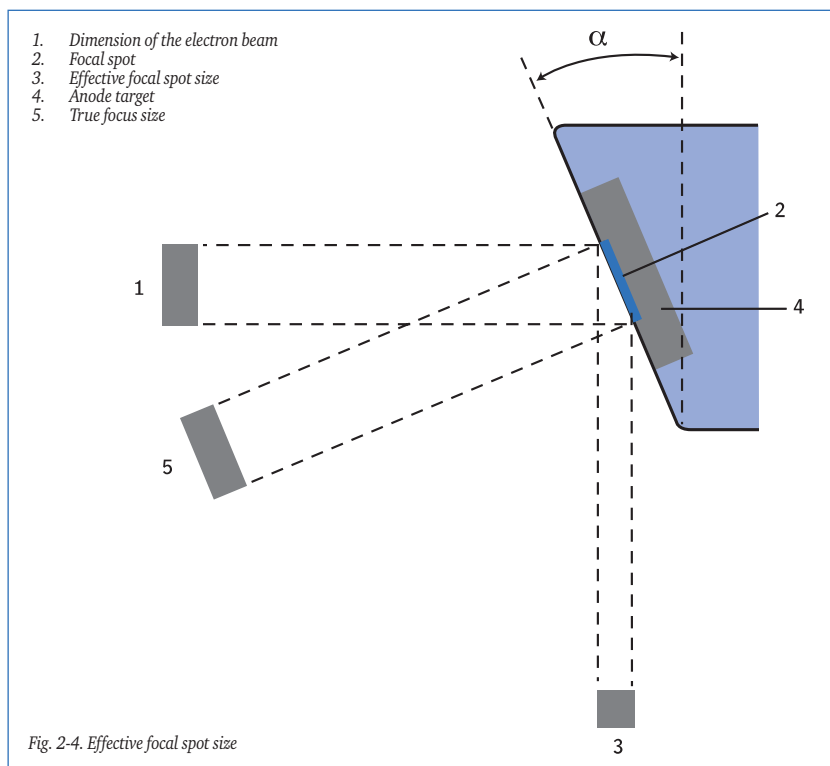

### 4.3 Tube voltage and tube current

The voltage across the X-ray tube determines the energy spectrum and so the hardness of the radiation, see figure 3-4. The intensity is proportional to the tube current, see figure 4-4. This graph shows that, contrary to a change in tube voltage, a change in tube current does not shift the spectrum (in other words: the hardness does not change).

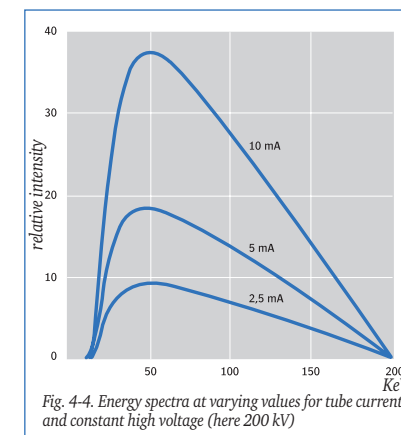
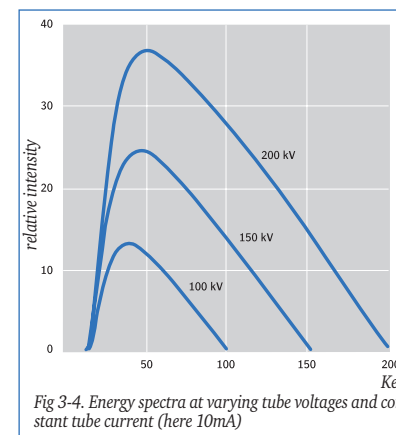

The energy spectrum is also influenced by the characteristics of the high voltage applied to the tube. When the spectrum of one X-ray tube on constant voltage is compared with that of another with a current of pulsating voltage, of the same kV value, both spectra will be slightly different. With a current of pulsating voltage there are, during each cycle, moments of relatively low voltage, during which there will be a greater proportion of “soft” X-rays, with their side-effects. This means that a set working on a constant voltage will provide a higher intensity of hard radiation than one on a pulsating voltage; although both working at the same nominal kV value.

However, even identical X-ray tubes may also show differences in generated energy. The energy generated by one 200 kV X-ray tube will not be true identical to the energy generated by another X-ray tube with the same applied voltage, not even if they are the same type of tube. This behaviour impedes individual calibration in kV of X-ray sets. Another reason why it is hard to calibrate an X-ray tube within a small tolerance band is, that the absolute level and wave characteristics of the supplied high voltage are difficult to measure.

It follows that it is difficult to standardise and calibrate X-ray equipment as far as spectra and kV-settings is concerned, which precludes the exchange of exposure charts, see section 9.1. Each X-ray set therefore requires its own specific exposure chart. Even the exchange of a similar control panel or another (length) of cable between control panel and X-ray tube can influence the level of energy and its spectrum. Usually after exchange of parts or repair the exposure chart for that particular type of X-ray set is normalised (curve-fitting) for the new combination of components. In practice adjusting the zero point of the exposure graph is sufficient.



## 4.4 Radioactive sources (isotopes)

### Natural radioactive sources

The elements from this group which have been used for the purposes of industrial radiography are radium and mesothorium. These give a very hard radiation, making them particularly suitable for examining very thick objects.

A disadvantage of natural sources, next to their high cost, is that it is not possible to make them in dimensions small enough for good quality images and still give sufficient activity.

### Artificial radioactive sources

Artificial radioactive sources for NDT are obtained by irradiation in a nuclear reactor. Since 1947, it has been possible to produce radioactive isotopes this way in relatively large quantities and in a reasonably pure state and particularly of sufficiently high concentration; the latter being extremely important in NDT because the size of the source has to be as small as possible. Among the many factors deciding a source suitability for non-destructive testing are the wavelength and intensity of its radiation, its half-life and its specific radiation. In fact, only a few of the many artificial radio-isotopes available have been found to be suitable for industrial radiography.

## 4.5 Advantages and disadvantages of artificial radioactive sources

### Advantages

1. require no electric power supply; easy to use in the field
2. can be obtained in a range of source diameters, so that if necessary a very short source-to-film distance with a small diameter source can be used, for example, for pipes of small diameter
3. a wide variety of radiation hardnesses
4. higher radiation hardness (more penetration power) than those of conventional X-ray equipment can be selected

### Disadvantages

1. cannot be switched off
2. the energy level (radiation hardness) cannot be adjusted
3. the intensity cannot be adjusted
4. limited service life due to source deterioration (half-life)
5. less contrast than X-ray equipment

## 4.6 Properties of radioactive sources

### Activity (source strength)

The activity of a radioactive substance is given by the number of atoms of the substance which disintegrate per second.

This is measured in Becquerels (Bq), 1 Becquerel corresponds to 1 disintegration per second ( $1 \text{ Bq} = 1/\text{s}$ ).

### Specific activity

The specific activity of a radioactive source is the activity of this substance per weight unit, expressed in Bq/g.

### Specific gamma-ray emission factor (k-factor)

The k-factor is the generally used unit for radiation output of a source and is defined as the activity measured at a fixed distance. It indicates the specific gamma-emission (gamma constant) measured at 1 metre distance.

The higher the k-factor, the smaller the source can be for a particular source strength. A source of small dimensions will improve the sharpness of a radiograph.

Table 1-4 shows the various k-factors and half-life values.

Isotope	Half-life	Specific gamma constant or k-factor
Ytterbium169	31 days	0.05
Iridium192	74 days	0.13
Selenium75	120 days	0.054
Cobalt60	5.3 years	0.35
Caesium137	30 years	0.09

Table 1-4 Various k-factors and half-life values

### Half-life of a radioactive source

Of an Iridium192 source with an activity of 40 GBq for example 10 GBq will remain after two half-lives (148 days), 5 GBq after three half-lives (222 days) etc.





### 5.1 X-ray equipment

X-ray sets are generally divided in three voltage categories, namely:

1. Up to 320 kV, mainly for use on intermittent, ambulatory work. Tubes are generally of the unipolar alternating current type. Higher voltages are hardly possible with this type of equipment because of insulation problems.
2. Up to 450 kV, mainly for use on continuous, stationary or semi-ambulatory work, because of their dimensions, limited manageability and weight. Tubes are of the bipolar direct current type.
3. Up to 16 MeV, so called Megavolt equipment. Virtually exclusively applied to stationary work.

The first two categories are suitable for radiography on most common objects. Objects of extreme thickness, however, require an energy even higher than 450 kV. In this case Megavolt equipment is used, if alternative sources such as Cobalt60 prove unsuitable. It will normally involve stationary installations of large dimensions and high weight. Lately, portable versions have become available meant for ambulatory use.

#### Types of X-ray tubes

Depending on the shape of the anode, X-ray tubes produce :

- a. a beam of radiation in one direction (directional tube)
- b. an annular beam (panoramic tube)

X-ray tubes are either unipolar or bipolar.

#### Bipolar tubes

Figure 1a-5 shows a bipolar tube. The bipolar tube has the advantage that the potential difference with respect to earth on both the anode and the cathode is equal to one-half of the tube voltage, which is a great help from the point-of-view of insulation. The exit window is necessarily situated in the middle of the tube. Bipolar tubes usually operate on direct current and are generally air, oil or water cooled. They are designed to operate at voltages of 100 to 450 kV and a tube current of up to 20 mA.

#### Unipolar tubes

In these (shorter) tubes, as shown in figure 1b-5, the anode is held at earth potential and the cathode only has a potential difference to earth. This makes anode cooling a simpler operation. It also means that for low/medium kilo-voltage sets, up to approx. 300 kV as often used in ambulant applications, a single simpler high voltage supply source will suffice. The radiation window is placed asymmetric which can be advantageous in practice.

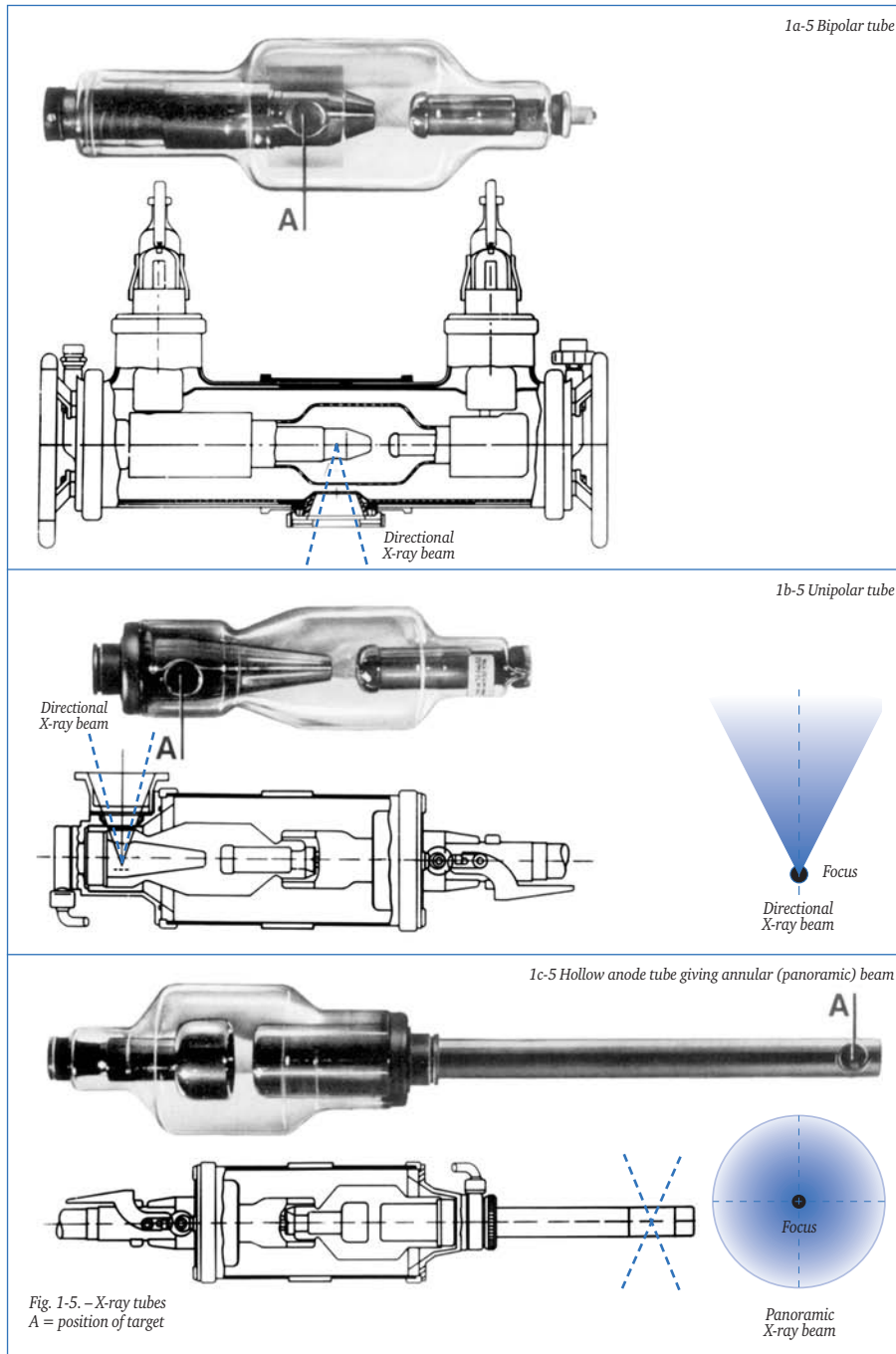

Fig. 1-5. - X-ray tubes  
A = position of target

### Special types of X-ray tubes

Unipolar X-ray tubes with a long hollow anode, as shown in fig. 1c-5, are generally known as “rod anode tube” and can be inserted into pipes or vessels. These tubes produce an annular (panoramic) beam over 360°, so allowing a complete circumferential weld to be radiographed in one exposure.

Figure 2-5 shows the conical anode of a (360°) panoramic tube, which allows a circumferential weld to be radiographed centrally, hence uniformly, from within. With this anode the axis of the electron beam must strike the top of the cone in such a way that the centre of the generated X-ray beam is perpendicular to the longitudinal axis of the tube.

*Note: Anodes shaped so that the centre of the generated X-ray beam is not perpendicular (oblique) to the centre line of the tube (which was acceptable in the past), are no longer allowed when work is to be performed to official standards. Tubes that produce a real perpendicular beam are known as “true panoramics”*

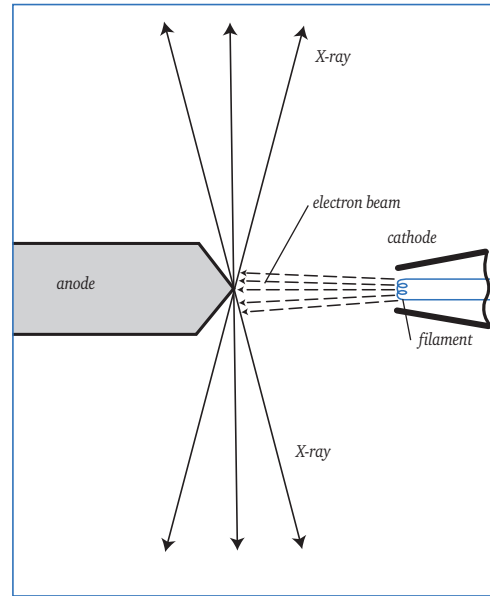

Fig. 2-5. Anode configuration for an annular panoramic tube

There are also panoramic tubes in which the electron beam is focused over an extended length by means of a magnetic lens or an electrostatic lens (Wehnelt-cylinder) to produce a very small focal spot size. These sets are called microfocus rod anode tubes with which a very small focal spot size, of less than 10 micrometers, can be achieved. Since the anode can be damaged relatively easy through overheating the anode is usually interchangeable. This requires a separate vacuum unit in order to restore the vacuum after replacement. The advantage of this construction is that with different types of anodes, different radiation patterns can be obtained for special applications. The maximum energy level is usually below 150 kV.

However, there are 150 kV microfocus tubes with a fixed anode for enlarging or scanning purposes, see section 17.1. With these tubes the tube current has to be kept low, because of heat dissipation limitations of the non-interchangeable anode.

Some X-ray tubes used in the radiography of plastics and aluminium are equipped with a beryllium window to allow the softer radiation generated at the lower tube voltages of 5 to 45 kV, to pass.

## 5.2 High voltage generators

Conventional (trans)portable X-ray equipment for use up to approximately 300 kV are provided with step-up HT transformers, rectifiers and smoothing capacitors. The X-ray tube and the circuitry of this equipment are usually placed in an insulated tank. In most cases these tank type sets use oil for insulation and cooling and weigh approximately 60 kg. Gas is used when weight is important; the set then weighs approximately 30 kg.

Figure 3-5 shows an integrated (all-in-one) tank set for 300 kV with an asymmetric window. At voltages over 300 kV housing everything in one tank becomes very difficult because the high voltage insulation would be inadequate.

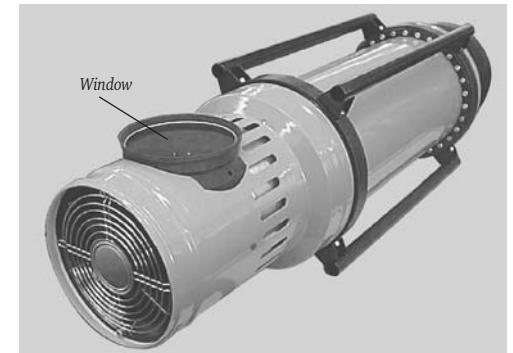

Fig. 3-5. “All-in-one” 300 kV tank set with an asymmetric window

Figure 4-5 shows a direct current X-ray tube with a symmetric window. Equipment up to 450 kV operating on direct current is connected to a separate high tension (HT) supply unit by means of HT leads. As a result this equipment is bigger and heavier than “all-in-one” tank sets and mostly meant for stationary or semi-ambulant use.

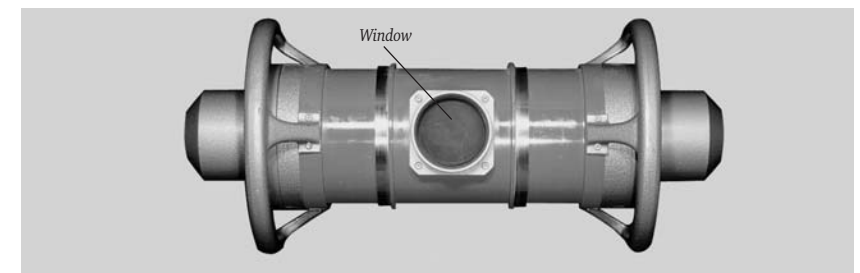

Fig. 4-5. Direct current X-ray tube for 450 kV with a symmetric window

The 300 kV “all-in-one” tank set and the 450 kV direct current X-ray tube **only** are of roughly the same dimensions.

Most tank sets are connected to a mains power supply with a frequency of 50 or 60 Hz. At this frequency the supply voltage can be transformed upward. This is followed by rectifying, which occurs in various forms. With some sets the X-ray tube itself functions as rectifier, so called single-phase rectifying. If there is no smoothing applied, considerable changes in voltage per cycle of alternating current will occur. This periodic and greatly varying high voltage affects the intensity and spectrum of the radiation generated, see section 4.3.



The intensity of radiation is increased by double-phased rectifying and varying degrees of smoothing. At very low voltage ripple these sets are considered constant potential (CP) equipment.

In the latest types of tank sets the mains frequency is first converted to a high frequency alternating current and only then transformed upward, which makes it easier still to smooth the ripple. At very high frequencies, up to 50 kHz, smoothing is hardly necessary anymore and such X-ray sets can be called CP systems. Additional features may be built in, for example an automatic warm-up facility, see note below. This type of circuitry with advanced electronics leads to a higher degree of reliability and significant space and weight reduction compared with earlier power supply systems. As a result of the various improvements that have gradually been implemented, present day (high frequency) AC X-ray sets perform as well as true CP sets.

*Note: Because of the high vacuum prevailing inside the X-ray tube, it carefully has to be warmed-up after a period of rest. During rest the vacuum deteriorates. This warm-up procedure has to be done in accordance with the supplier's instructions, to prevent high voltage short-circuiting which might damage the tube or render it useless.*

### 5.3 Megavolt equipment

The equipment described in sections 5.1 and 5.2 is used to generate X-radiation up to approximately 450 kV. However, sometimes higher energy levels are needed. Several types of equipment have been built to operate in the 1 MeV to 16 MeV range. In industrial radiography almost exclusively Bètatrons or linear accelerators (linacs) are used. Operating high-energy X-ray installations requires (costly) safety precautions.

#### The Bètatron

The Bètatron is an electron accelerator, which can produce X-radiation in the 2-30 MeV energy range. The electrons are emitted into a round-sectioned donut shaped glass vacuum tube, as shown in figure 5-5. After several millions of revolutions the electrons reach maximum energy and are deflected towards the target. On the target, part of the electron energy is converted into a tangentially directed beam of X-radiation.

To obtain a reasonably high radiation intensity, most Bètatrons have been designed to operate in the 10-30 MeV energy range, as these voltages achieve maximum conversion rate of electron energy into radiation. Even so the output of Bètatrons is usually small compared to linacs. Transportable low energy Bètatrons (2-6 MeV) have been built, but these generally have a low radiation output, which limits their application.

One advantage of Bètatrons is that they can be built with very small (micromillimeter) focal spots. A disadvantage is that with these very high energy levels the X-ray beam is usually narrow, and the coverage of larger film sizes is only possible by using increased source-to-film distances. The extended exposure times required can be a practical problem.

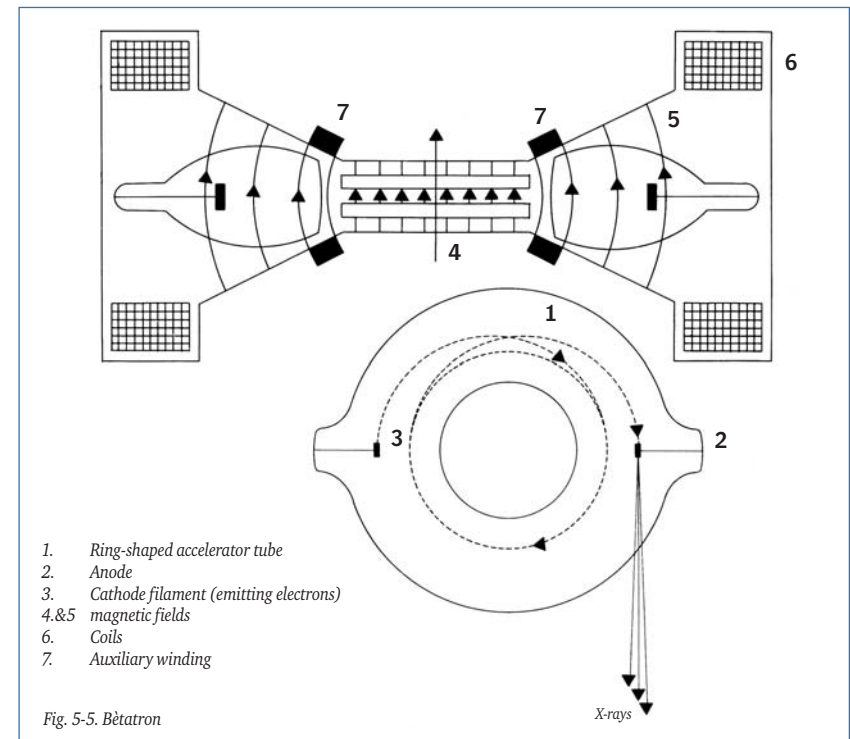

#### The linear accelerator (linac)

The energy levels mostly used for linacs (linear accelerators) are 4 MeV and 8 MeV. Linear accelerators can be constructed for one or two energy levels.

In the travelling-wave linac, the acceleration of electrons from a heated filament to very high energies results from the electrons “riding” a high-frequency (3-10 MHz) electromagnetic wave travelling in a straight line down an acceleration tube (the hollow guide). The electrons are bunched into pulses at a frequency of a few hundred pulses per second. The target, which the electrons strike to generate X-radiation, is at the opposite end of the main wave guide of the filament assembly. This is a transmission type target from which the radiation beam passes in a straight line.

The X-ray output from a linear accelerator is many times higher than from a Bètatron of the same energy. An 8 MeV linac with a 2 mm diameter focal spot can deliver a radiation dose rate of 30 Sv/minute at 1 metre distance from the focus. Small light-weight portable linacs of 3 MeV capacity can have outputs of 1.5 Sv/minute at 1 metre distance.



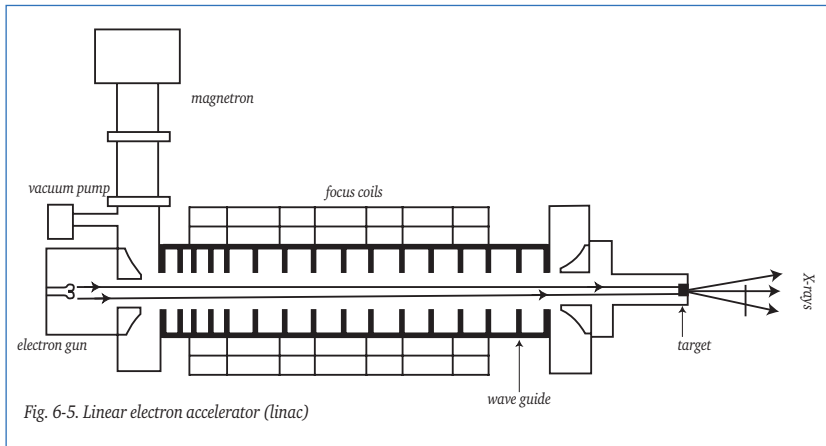

Fig. 6-5. Linear electron accelerator (linac)

The main properties of a linear accelerator are:

1. very high output of radiation
2. very small focal spot dimensions (<2 mm)
3. considerable weight (approx. 1200 kg for an 8 MeV stationary installation)

Figure 7-5 shows an 8 MeV linac in a radiation bunker examining a pump housing.

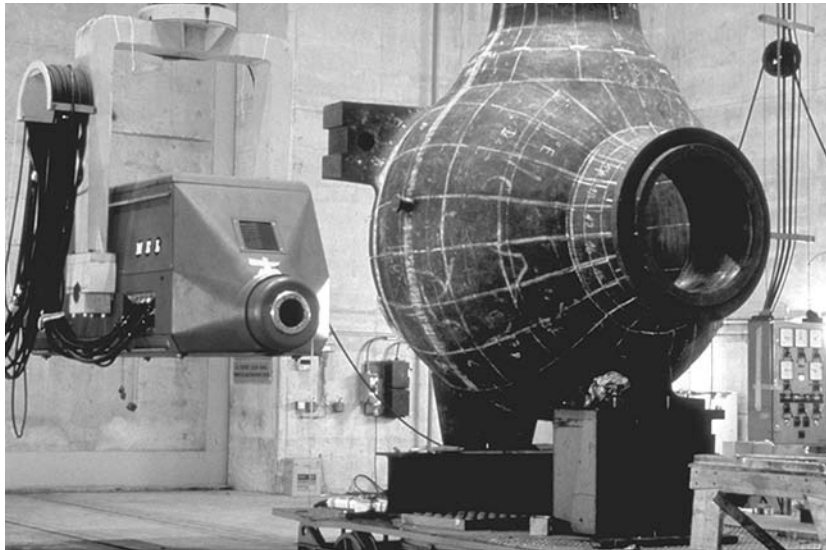

Fig.7-5. Linac and pump house in a radiation bunker

## 5.4 Radioactive sources

Table 1-5 shows various radioactive sources for industrial NDT. The most commonly used ones are Cobalt, Iridium and increasingly Selenium. Selenium is very attractive while it permits lighter containers than Iridium. Due to its average energy level it often is a good alternative for an X-ray tube, also attractive while no electricity is needed.

Element	Symbol	Mass Number	Specific gamma constant k-factor	Average energy level in MeV
Cobalt60	Co	60	0.35	1.25
Caesium137	Cs	137	0.09	0.66
Iridium192	Ir	192	0.13	0.45
Selenium75	Se	75	0.054	0.32
Ytterbium169	Yb	169	0.05	0.2
Thulium170	Tm	170	0.001	0.072

Table 1-5. Radioactive sources used in industrial radiography, in sequence of nominal (average) energy level

### Average energy level (nominal value)

The spectrum of a source has one or more energy lines, as shown in figure 2-2. For sources with multiple energy lines an average energy level is assumed, the so-called nominal value.

Source	Number of spectrum lines	Main energy levels in MeV	Nominal value in MeV
Cobalt60	2	1.17 and 1.34 MeV	1.25 MeV.
Caesium137	1	0.66 MeV	0.66 MeV
Iridium192	>10	0.3; 0.31; 0.32; 0.47 en 0.6 MeV	0.45 MeV.
Selenium75	>4	120, 140 and 400 keV	320 keV.
Ytterbium169	>6	0.06 and 0.2 MeV	200 keV.
Thulium170	2	52 and 84 keV	72 keV.

Table 2-5. Radiation spectra and nominal values

On the basis of these spectra data it is clear that Co60, Cs137 and Ir192 sources produce high-energy radiation and are therefore well suited to irradiate thick materials.

Yb169, on the other hand, is a source that produces relatively soft radiation and is of a very small size (0.5 mm), which makes it particularly suitable for radiographic examination of circumferential welds in pipes of a small diameter and thin wall thickness, with the source centrally positioned so that the weld can be exposed uniformly in one exposure, as shown in figure 8-5.

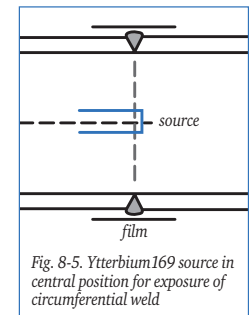

Fig. 8-5. Ytterbium 169 source in central position for exposure of circumferential weld





## 5.5 Source holders (capsules)

All gamma-ray sources for radiography are supplied in hermetically sealed, corrosion resistant source holders (capsules), made out of monel, vanadium or titanium.

The Atomic Energy Authority in the country of origin encapsulates the radioactive material. The supplier will supply the source with a certificate which indicates the type of source, its serial number, the activity at a certain date, and a disintegration graph.

The radiation material proper, also called the source or pellet, ranges in size from 1 to 4 mm. The size is dictated by the specific radiation activity of the source material.

The outside dimensions of the cylindrical capsule are approximately 5.5 x 15 mm, as shown in figure 9-5.

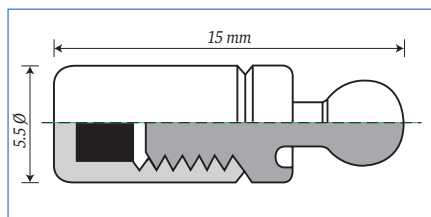

Fig. 9-5. Cross-section of a capsule for a radioactive source



Fig. 10-5. Sealed capsule

## 5.6 Transport- and exposure containers

Transportation and handling of sealed sources are subject to strict international safety regulations, as a source is continuously emitting radiation in all directions, in contrast to an X-ray tube which can be switched off. During transportation and use the source must be surrounded by a volume of radiation absorbing material, which in turn is encapsulated in a container. The level of radioactivity at the outside surface of the container shall not exceed the legally established maximum limit.

Like the transport container, the exposure container needs to be robust and must function safely at all times. The exposure container, also called camera, must be fail-safe and water- and dirt proof. It must also not be effected by impact.

Moreover, if the radiation-absorbing material, for example lead, melts (in a fire) the radiation absorbing qualities must not be lost.

This requires a casing made of a material with a high melting point, for example steel. Besides lead, increasingly a new sintered material with very high tungsten content (97%) is used as shielding material. This material is easily worked and finished and not prone to melting.

Also greatly depleted uranium (with the highest radiation absorption) is used for shielding, resulting in very compact exposure containers. A disadvantage of this material, however, is that it has a certain minimal radioactivity, which is reason that in some countries the use of depleted uranium is not allowed.

Regardless of the shielding material used, all containers have a considerable weight in common.

There are several solutions to the problem of safely storing a source on the one hand, and of putting it in a simple but absolutely safe manner in its radiation position on the other hand. Two regularly used constructions for this purpose are: source S is situated in a rotating cylinder, as shown in figure 11-5, or in an S-channel container as shown in figure 12-5.

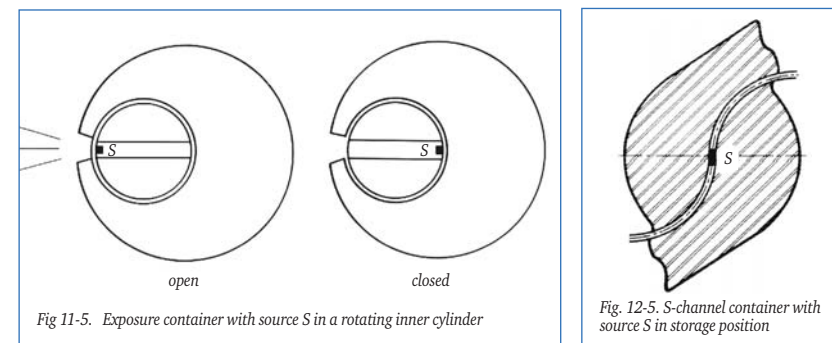

The S-channel container is usually provided with a means to move the source out from a distance (after all, distance is the safest protection from radiation). This may be done by means of a flexible cable in a hose (Teleflex design) as shown in figures 13-5 and 14-5.

With this construction it is possible to extend the flexible hose in such a way that the source can safely be moved several metres out of the container to the most favourable exposure position.

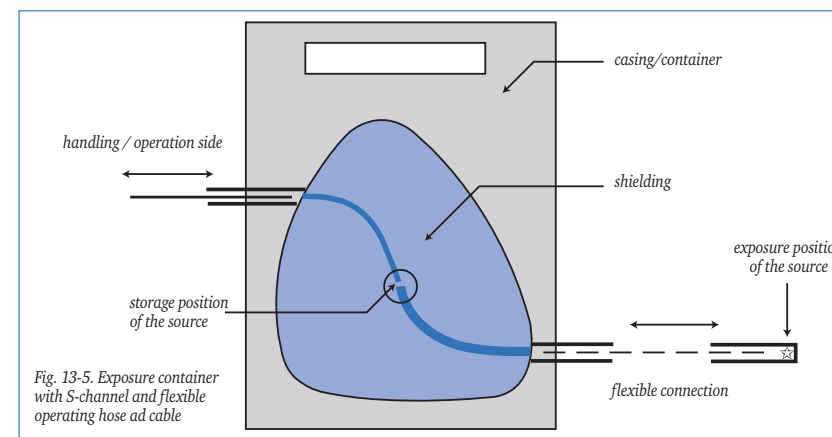

Fig. 13-5. Exposure container with S-channel and flexible operating hose and cable



Figure 14-5 shows an S-channel container with a flexible (metal) hose and cable in rolled up (transport) position.



Fig. 14-5. S-channel container with the flexible cable and deployment mechanism.

Figure 15-5 shows a more recent (2006) S-channel Selenium75 container with operation hoses and pigtail. Selenium75 radio-isotope is becoming popular since new production (enrichment) methods resulted in a much better k-factor. Thus for a certain activity (source strength) a much smaller source size (focus) is achieved. This results in a better/sharper image quality than could be achieved with the old Selenium75 production method.

Due to its average energy level of 320 kV, Selenium75 increasingly replaces X-ray equipment for a thickness range from 5 mm to 30 mm of steel. This eliminates the need for electric power, very attractive in the field for reasons of electrical safety and more convenient at remote- or work locations with difficult access (high, deep, offshore, refineries, etc). Last but not least, a Selenium container is of much lower weight than needed for an Iridium192 container with the same source strength.



Fig. 15-5. S-channel container for Selenium75 with pigtail (at right) and operating hoses (at left)

To enable radiography on work sites with (many) people in the vicinity, for example on offshore installations or in assembly halls, containers with rotating cylinders and collimators were developed so that only the beam of radiation required for the radiograph is emitted.

The remainder of radiation is absorbed by the collimator material which allows people to work safely at a distance of a few metres while radiography is in progress. Such containers with collimators are known by the name of “CARE” (Confined Area Radiation Equipment) or “LORA” (Low Radiation) equipment.

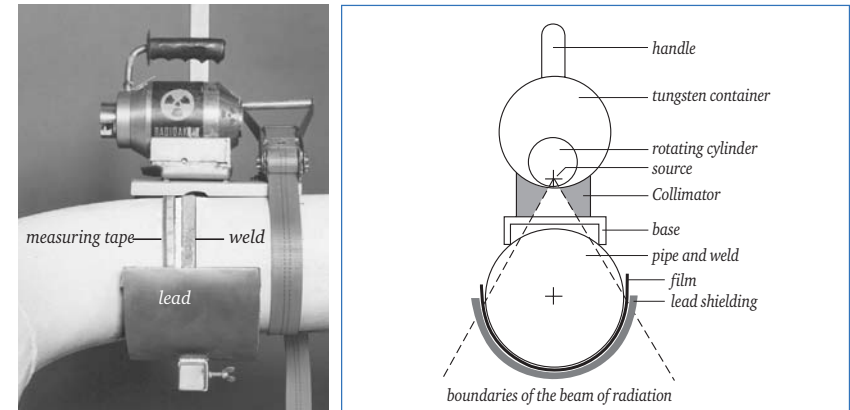

Fig. 16a-5. Gamma container with collimator on a circumferential weld in a pipe

Fig. 16b-5. Cross-section of CARE/LORA container on the pipe

Without collimating the minimum safety distance is considerably more than 10 metres (in all directions!). Such containers with collimators are particularly suitable for frequent and identical repetitive NDT work, for example radiographic testing of welds in pipes of < 300 mm diameter.

Figure 16a-5 shows such a special container with collimator set up for a double wall radiograph. The cross-section drawing of figure 16b-5 shows the boundaries of the beam of radiation. For bigger focus-to-film distances, longer collimators are used to restrict the beam of radiation.

This type of container is suitable for Iridium sources up to 1000 GBq and weighs “only” approx. 20 kg. A similar system (Saferad) with a weight of up to 15 kg exists, using Selenium75, which almost eliminates the usual disruption to construction, maintenance and process operations in the vicinity of the exposure.

## 5.7 Checking for container leakage

A sealed radioactive source (capsule) might start to leak and become an open source as a result of corrosion, mechanical damage, chemical reactions, fire, explosion etc. Regular mandatory “wipe-tests” by specialists serve to detect leakage at an early stage.





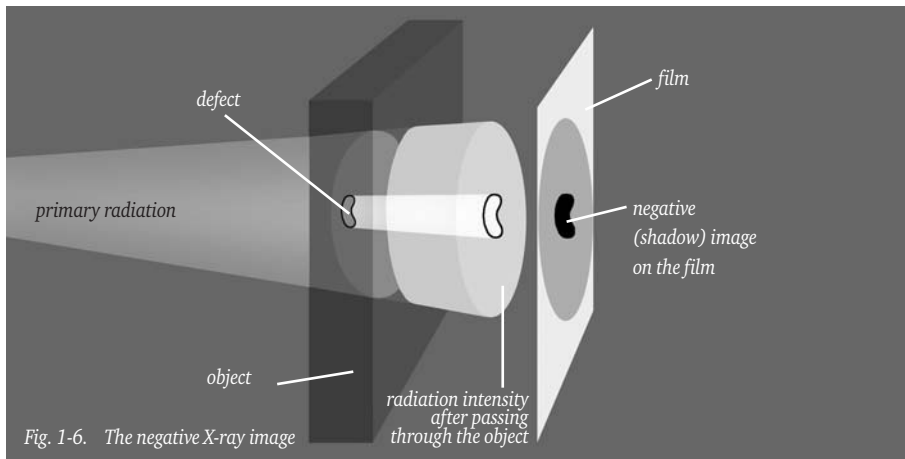

Fig. 1-6. The negative X-ray image

## 6 Radiation images, filters and intensifying screens

To influence the effects of radiation on an image, filters and intensifying screens are used to :

- filter / harden the radiation to influence contrast and/or
- to intensify the effect of radiation to improve contrast

### 6.1 Radiation images

The intensity of a beam of X-rays or gamma-rays undergoes local attenuation as it passes through an object, due to absorption and scattering of the radiation. On a uniform object attenuation of the primary beam will also be uniform and the film evenly exposed. If the object contains defects or is of variable thickness, the surface of the film will be unevenly exposed resulting in a shadow image of the object and the defects in it. When the film is processed the variations in radiation intensity show up as varying film densities; higher radiation intensity producing higher film density resulting in a negative X-ray image as shown in figure 1-6.

When the primary beam is partly absorbed in the object, some radiation, as shown in figure 2-6, will be scattered and reach the film as secondary radiation by an indirect path. The quality of the radiograph is reduced by this scattered radiation, and it is important to keep its effects to a minimum.

At any point P on the film, therefore, the total radiation reaching that point is made up of some transmitted primary radiation forming the image of cavity (N), the “image forming”- or direct radiation intensity  $I_p$ , and some secondary “non-image forming”, scattered radiation, intensity  $I_s$ . Hence, the total radiation intensity at P is  $(I_p + I_s)$ .

The ratio  $I_s/I_p$  is called the “scattered radiation factor” and can be as high as 10 for great wall thicknesses, which means that the scattered radiation is ten times higher than the image-forming radiation. The ratio  $(I_p + I_s)/I_p = 1 + I_s/I_p$  is called the “build-up factor” and is of considerable importance for the detectability of defects. It usually has a value between 2 and 20, depending on radiation energy and object thickness.

It must also be appreciated that any object in the neighbourhood of the object being examined (table, walls, ground and so on) which is struck by the gamma- or X-rays will partially reflect these rays in the form of “backscatter” which is liable to fog the film.

Backscatter coming from the object under examination is less hard than the primary radiation that has caused it and can be intercepted by a metal filter between object and film. Radiation scattered by objects nearby the film can be intercepted by means of a protective sheet of lead at the rear face of the film cassette.

Fig. 2-6. Image forming and non-image forming radiation

Only the radiation from source (S) that reaches the film in straight lines via beam section DE, produces an image of cavity N at P. The remainder, not reaching P directly, is scattered radiation, no defect image forming thus reducing the image quality.

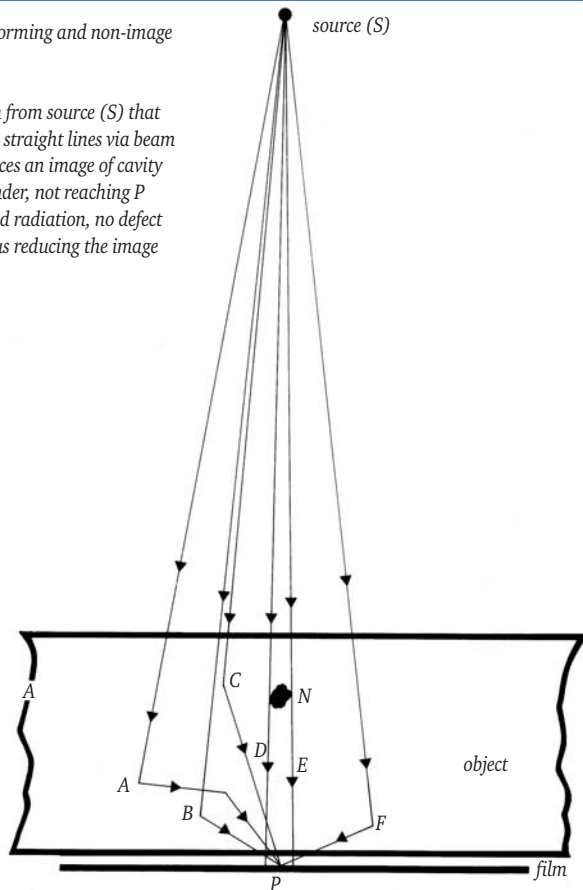

Scattered radiation also occurs in radiographic examination of cylindrical objects, as shown in figure 3-6.

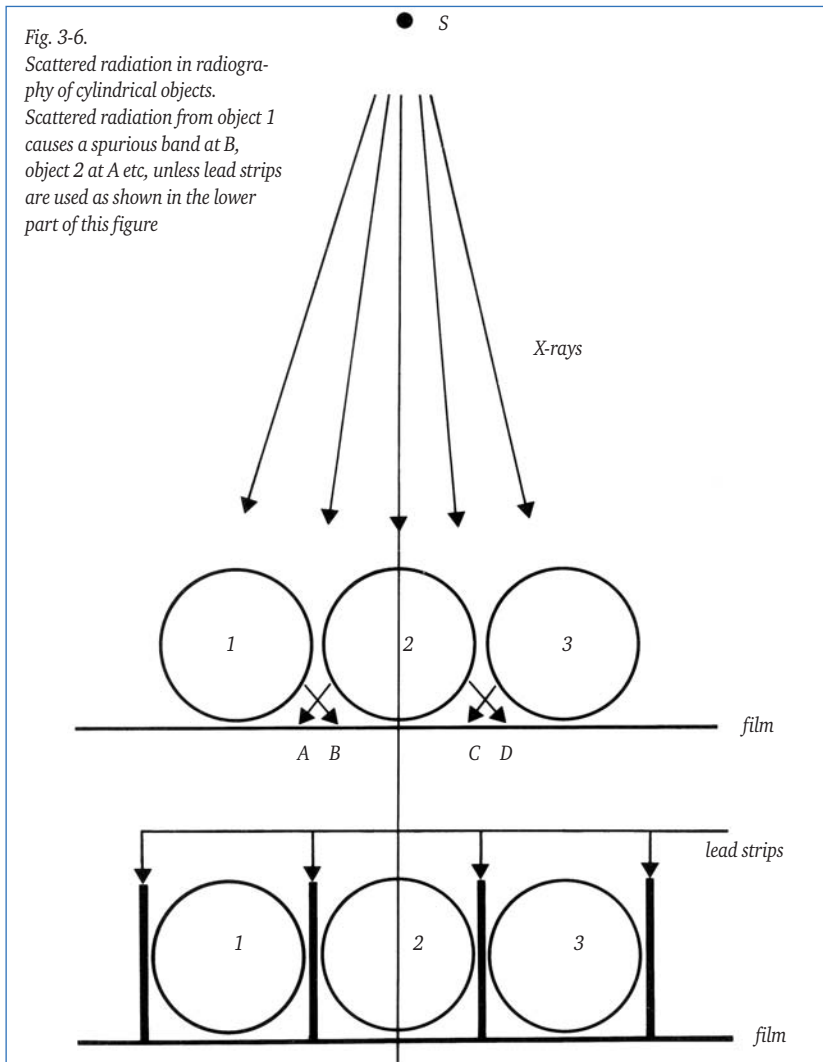

The effects of scattered radiation can be further reduced by :

- limiting the size of the radiation beam to a minimum with a diaphragm in front of the tube window
- using a cone to localise the beam, a so called collimator
- the use of masks: lead strips around the edges of the object.

## 6.2 Radiation filters

When a metal plate, usually lead or copper, is placed between the tube window and the object, radiation “hardening” occurs leading to a lower image contrast. This may be counter-balanced by a metal filter placed immediately behind the object (i.e. between object and film). This filter will cause the (softer) scattered radiation passing through the object to be absorbed by the filter to a greater extent than the primary (harder) radiation. This also improves the image quality.

If the edges of an object being radiographed are not close to the film (as in the case of a cylindrical body in figure 3-6) considerable scatter of the primary radiation can occur, leading to fogging. This scatter can be prevented by positioning sheets of lead foil between the object and the film as illustrated in this figure.

Reducing the contrast by filtration is also desirable when a radiographic image of an object of widely varying thicknesses has to be obtained on a single film see section 18.2.

Typical filter thicknesses are :

- 0.1 – 0.25 mm lead for 300 kV X-rays
- 0.25 – 1.0 mm lead for 400 kV X-rays

## 6.3 Intensifying screens

The radiographic image is formed by only approximately 1 % of the amount of radiation energy exposed at the film. The rest passes through the film and is consequently not used. To utilise more of the available radiation energy, the film is sandwiched between two intensifying screens. Different types of material are being used for this purpose.

### Lead screens

Under the impact of X-rays and gamma-rays, lead screens emit electrons to which the film is sensitive. In industrial radiography this effect is made use of: the film is placed between two layers of lead to achieve the intensifying effect and intensity improvement of approximately factor 4 can be realised. This method of intensification is used within the energy range of 80 keV to 420 keV, and applies equally to X-ray or gamma-radiation, such as produced by Iridium192.

Intensifying screens are made up of two homogeneous sheets of lead foil (stuck on to a thin base such as a sheet of paper or cardboard) between which the film is placed: the so called front and back screens.

The thickness of the front screen (source side) must match the hardness of the radiation being used, so that it will pass the primary radiation while stopping as much as possible of the secondary radiation (which has a longer wavelength and is consequently less penetrating).



The lead foil of the front screen is usually 0.02 to 0.15 mm thick. The front screen acts not only as an intensifier of the primary radiation, but also as an absorbing filter of the softer scatter, which enters in part at an oblique angle, see figure 2-6. The thickness of the back screen is not critical and is usually approx. 0.25 mm.

The surface of lead screens is polished to allow as close a contact as possible with the surface of the film. Flaws such as scratches or cracks on the surface of the metal will be visible in the radiograph and must, therefore, be avoided. There are also X-ray film cassettes on the market with built-in lead screens and vacuum packed to ensure perfect contact between emulsion and lead foil surface.

Figure 4a-6 and figure 4b-6 clearly show the positive effect of the use of lead screens.

Summarizing, the effects of the use of lead screens are :

- improvement in contrast and image detail as a result of reduced scatter
- decrease in exposure time

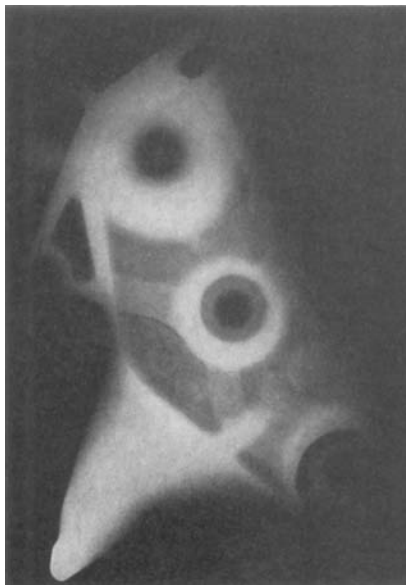

Fig. 4a-6. Radiograph of a casting without lead intensifying screens

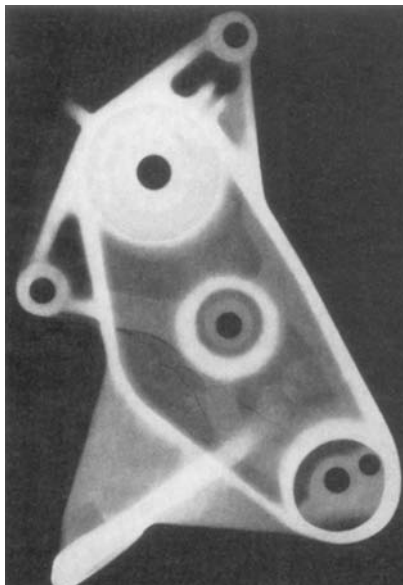

Fig. 4b-6. Radiograph of a casting with lead intensifying screens

### Steel and copper screens

For high-energy radiation, lead is not the best material for intensifying screens. With Cobalt60 gamma-rays, copper or steel have been shown to produce better quality radiographs than lead screens. With megavoltage X-rays in the energy range 5-8 MeV (linac) thick copper screens produce better radiographs than lead screens of any thickness.

### Fluorescent screens

The term fluorescence (often mistaken for phosphorescence) is used to indicate the characteristic of a substance to instantly emit light under the influence of electromagnetic radiation. The moment radiation stops, so does the lighting effect. This phenomenon is made good use of in film based radiography. Certain substances emit so much light when subjected to ionising radiation, that they have considerably more effect on the light sensitive film than the direct ionising radiation itself.

- The term phosphorescence is used to describe the same luminescent phenomenon, but once the electromagnetic radiation ceases, light fades slowly (so called after-glow).
- NDT additionally uses the “memory effect” of some phosphorous compounds to store a latent radiographic image in order to develop it later into a visible image with the aid of laser stimulation, see section 16.4.

### Fluorescent salt screens

Fluorescent screens consist of a thin, flexible base coated with a fluorescent layer made up from micro-crystals of a suitable metallic salt (rare earth; usually calcium tungstate) which fluoresce when subjected to radiation. The radiation makes the screen light up. The light intensity is in direct proportion to the radiation intensity. With these screens a very high intensification factor of 50 can be achieved, which means a significant reduction in exposure time. The image quality, however, is poor because of increased image unsharpness. Fluorescent screens are only used in industrial radiography when a drastic reduction of exposure time, in combination with the detection of large defects, is required.

### Fluorometallic screens

Apart from fluorescent and lead intensifying screens, there are fluorometallic screens which to a certain extent combine the advantages of both. These screens are provided with a lead foil between the film base and the fluorescent layer. This type of screen is intended to be used in combination with so-called RCF-film (Rapid Cycle Film) of the types F6 or F8, see section 8.1.

The degree of intensification achieved largely depends on the spectral sensitivity of the X-ray film for the light emitted by the screens. Due to the considerable exposure time reduction the application is attractive for work on lay barges and in refineries.

To achieve satisfactory radiographs with fluorometallic screens, they should be used in combination with the appropriate F-film type.

When used correctly and under favourable conditions, exposure time can be reduced by a factor 5 to 10, compared with D7 film in combination with lead screens. This is not a constant factor because the energy level applied (radiation hardness) and ambient temperature also affects the extent of fluorescence. For example, at 200 kV a factor 10 can be achieved, but with Iridium192 (nominal value 450 kV) it will only be a factor 5 compared to D7 film. Table 1-6 shows the relative exposure factors for the RCF-technique.

Film system	Relative exposure time	
	200 kV	Ir192 (450 kV)
F6 + RCF screens	0.1	0.2
D7 + lead screens	1.0	1.0

Table 1-6. Relative exposure factors for RCF technique

A total processing cycle of a few minutes is possible with the use of an automatic film processor which makes it a very attractive system to deploy offshore (on lay barges) where weld examination has to be done at a very fast rate and few concessions are made towards image quality. Fig. 5-6 shows that a time saving at  $10^{(3.7-2.8)}$  or  $10^{0.9}$  works out at approximately a factor 8. The actual time saving is often closer to factor 10.

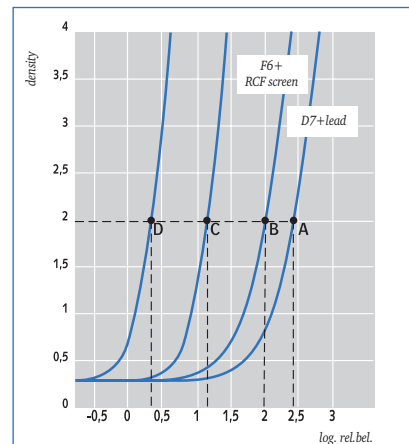

Fig. 5-6. Relative exposure time RCF and lead intensifying screen, for 300kV

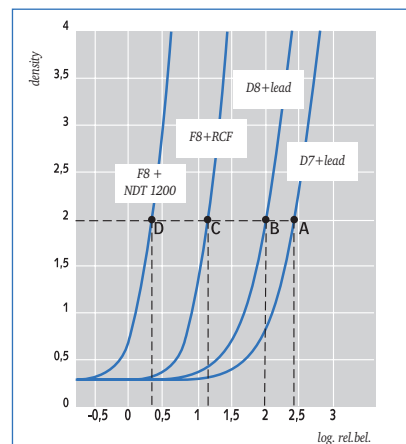

Fig. 6-6. Speed comparison F8 film + NDT1200 and RCF versus D7 and D8 + lead, for 200kV

These RCF screens are also used for “on-stream” examination - also known as profile radiography- (see section 18.6), whereby long exposure times and mostly hard (gamma) radiation are applied because of the penetrating power required. However, the relatively long exposure time (causing reciprocity) and hard radiation (Cobalt60) together considerably reduce the light emission effect, as tables 1-6 and 2-6 show.

On balance for on-stream inspection, the relative time saving is much smaller; usually no more than a factor 2 for an F6-film (at Ir192 and Co60) instead of 10 in the D7 lead screen technique. See the bold figures (2.5 and 1.7) in table 2-6.

Figure 6-6 gives an overview of graphs from which the relative exposure times can be deduced when using different films and screens at 200 kV, (for film-density 2). The graph shows that an F8-film with RCF screen (point C) is approximately 8 times faster than a D8-film with lead (point B) and approximately 15 times faster than a D7-film with lead (point A). Since on-stream examination as well as examination of concrete, and also flash radiography (see section 18.7) allow concessions to image quality, a special fluorometallic screen (NDT1200) has been developed with extremely high light emission. In combination with an F8-film it may result in a reduction in exposure time at a factor 100 at 200 kV, against a D7-film with lead (point D as opposed to point A in figure 6-6), or even a factor 140 to 165, depending on source selection, see table 2-6. The intensification factor of the NDT1200 screens increases significantly at lower temperatures.

Table 2-6 shows the effect of radiation hardness on relative exposure times for the various film/screen combinations compared with D7 film with lead screen. Noticeably, for the NDT1200 screen and F-8 film the factor increases with the increase in energy, but for the F6 film the factor decreases at energy levels exceeding 300 keV.

Relative exposure times						
Energy level	Screen type	Film F8	Factor	Film F6	Factor	Film D7
100 kV	NDT1200	0.01	100	0.05	20	1
	RCF none	0.03	33	0.17	6	
300 kV	NDT1200+Pb	0.008	125	0.04	25	1
	RCF	0.02	50	0.13	8	
	Lead					
Ir192 450 keV	NDT1200+Pb	0.007	<b>140</b>	0.06	17	1
	RCF	0.035	30	0.4	2.5	
	Lead					
Co60 1.25 MeV	NDT1200	0.006	<b>165</b>	0.1	10	1
	RCF	0.04	25	0.6	1.7	
	Lead					

Table 2-6. Relative exposure times for NDT1200, RCF and lead screens.

It is clear from the above tables and graphs that there are many ways to reduce the exposure time or radiation dose needed. The required image quality is decisive (a higher exposure rate automatically means reduced image quality), and next the economic factors, for example the cost of the screens against time saved need to be weighed.



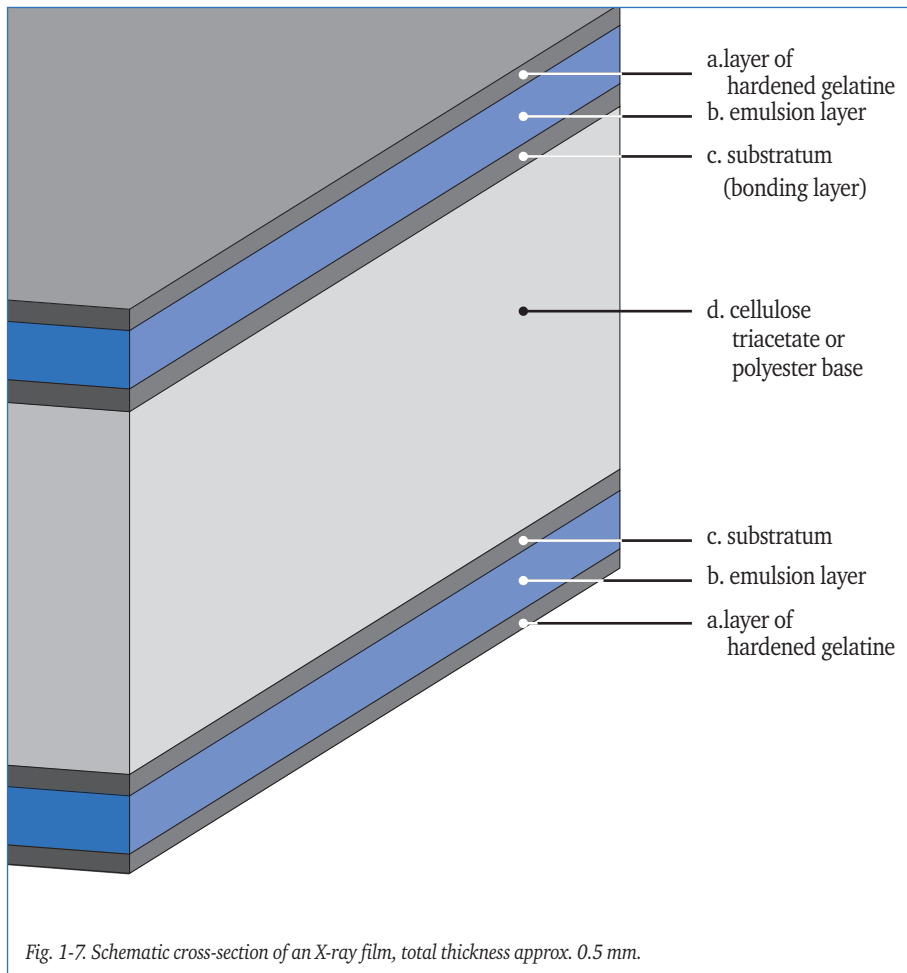

Fig. 1-7. Schematic cross-section of an X-ray film, total thickness approx. 0.5 mm.

## 7 The X-ray film and its properties

### 7.1 Structure of the X-ray film

An X-ray film, total thickness approx. 0.5 mm, is made up of seven layers, see figure 1-7 consisting of :

A transparent cellulose triacetate or polyester base (d). On both sides of this base are applied:

- a layer of hardened gelatine (a) to protect the emulsion
- emulsion layer (b) which is suspended in gelatine, sensitive to radiation
- a very thin layer called the substratum (c) which bonds the emulsion layer to the base

The normal X-ray film, therefore, has two coatings of emulsion doubling the speed compared to a film with a single emulsion layer. Photographic emulsion is a substance sensitive to ionising radiation and light, and consists of microscopic particles of silver halide crystals suspended in gelatine.

*Note: In the past radiography on paper was not unusual. In this ‘instant cycle’ process results became available within 60 seconds. The quality of the images, however, was extremely poor and the life of the film limited to a few months.*

*The availability of better and faster “instant cycle” techniques such as digital radiography (see chapter 16), has made radiography on paper obsolete.*

### 7.2 Radiographic image

#### Latent image

When light or X-radiation strikes a sensitive emulsion, the portions receiving a sufficient quantity of radiation undergo a change; extremely small particles of silver halide crystals are converted into metallic silver.

These traces of silver are so minute that the sensitive layer remains to all appearances unchanged. The number of silver particles produced is higher in the portions struck by a greater quantity of radiation and less high where struck by a lesser quantity.

In this manner a complete, though as yet invisible, image is formed in the light-sensitive layer when exposure takes place, and this image is called the “latent image”.

Before and after exposure, but prior to development of the film, the latent image has a shiny pale green appearance.





### Developing the latent image

Development is the process by which a latent image is converted into a visible image. This result is obtained by selective reduction into black metallic silver of the silver halide crystals in the emulsion. These crystals carry traces of metallic silver and in doing so form the latent image. Several chemical substances can reduce the exposed silver halides to metallic silver: these are called “developing agents”.

## 7.3 Characteristics of the X-ray film

The use of X-ray film and the definition of its characteristics call for an adequate knowledge of sensitometry. This is the science which studies the photographic properties of a film, and the methods enabling these to be measured.

The density (or blackness) of the photographic layer, after development under closely defined conditions, depends on exposure. By exposure is meant a combination of radiation dose striking the emulsion, that is to say intensity (symbol  $I$ ) and the exposure time (symbol  $t$ ). In sensitometry, the relationship between exposure and density ( $I.t$ ) is shown in the so-called characteristic curve or density curve.

### Density (optical)

When a photographic film is placed on an illuminated screen for viewing, it will be observed that the image is made up of areas of differing brightness, dependent on the local optical densities (amount of silver particles) of the developed emulsion.

Density ( $D$ ) is defined as the logarithm to base 10 of the ratio of the incident light  $I_0$  and the transmitted light through the film  $I_t$ , therefore:  $D = \log (I_0 / I_t)$ . Density is measured by a densitometer, see section 9.2.

Industrial radiography on conventional film covers a density range from 0 to 4, a difference corresponding with a factor 10,000.

### Contrast

The contrast of an image is defined as the relative brightness between an image and the adjacent background.

The contrast between two densities  $D_1$  and  $D_2$  on an X-ray film is the density difference between them and is usually termed the “radiographic contrast”.

Film contrast, or emulsion contrast, are rather vague terms used to describe the overall contrast inherent in a particular type of film. When an emulsion type shows most of the image contrasts present, the film is said to be “of high contrast” or “hard”.

For the measurement of film contrast, the term “film gradient” is used, for which the symbol is  $G_D$ . Suffix  $D$  indicates the density at which  $G$  is measured.

## 7.4 Characteristic curve (density curve)

The characteristic or density curve indicates the relationship between increasing exposures and resulting density. By exposure ( $E$ ) is meant the radiation dose on the film emulsion. It is the product of radiation intensity ( $I_0$ ) and exposure time ( $t$ ), therefore:  $E = I_0.t$

The ratio between different exposures and related densities is not usually plotted on a linear scale but on a logarithmic scale; i.e. density  $D$  versus  $\log E$ .

The curve is obtained by applying increasing exposures to a series of successive areas of a strip of film, whereby each following exposure is a certain factor (for example 2) greater than the previous one. After development, the densities ( $D$ ) are measured by means of a densitometer and then plotted against the logarithmic values of the corresponding exposures ( $\log E$ ). The points obtained are then joined together by a continuous line. It is not necessary to know the absolute exposure values; relative values can be used, so at a fixed X-ray intensity only exposure time needs to be changed.

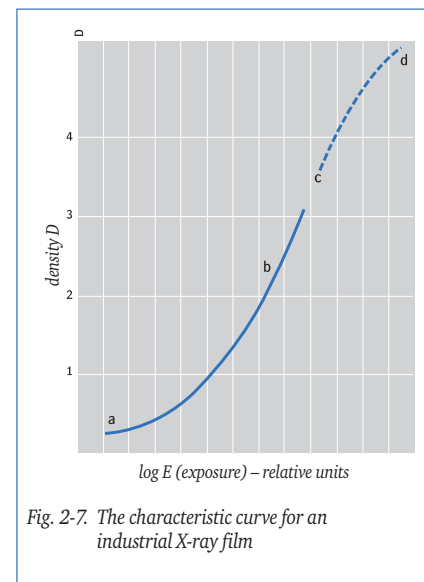

Density ( $D$ ) of a photographic emulsion does not increase linearly with exposure ( $E$ ) over the entire density range, but has a shape as in figure 2-7. The lower part of the curve (a-b) is called the “toe”, the middle part (b-c) is called the “straight line (linear) portion”, and the upper part (c-d) is called the “shoulder”. Usually the characteristic curve of industrial X-ray films shows an S-like shape.

The shoulder of a characteristic curve relating to industrial X-ray film corresponds to densities higher than 4. Since such densities are too high for normal film viewing, the curve from density  $D = 3.5$  upwards is shown as a broken line.

It should be noted that the straight-line portion (b-c) is not truly straight, but slightly continues the trend of the toe of the curve.





### Gradient of the density curve

The density curve shows one of the most important characteristics of a film. The slope of the characteristic curve at any given point is equal to the slope of the tangent line at this point. This slope ( $a/b$  in figure 3-7), is called the “film gradient”  $G_D$ , “film contrast” or the “film gamma”.

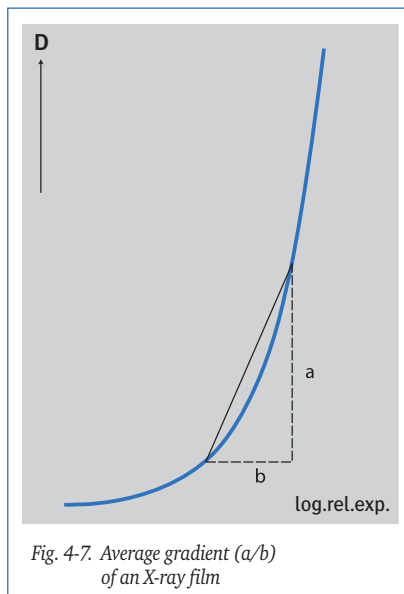
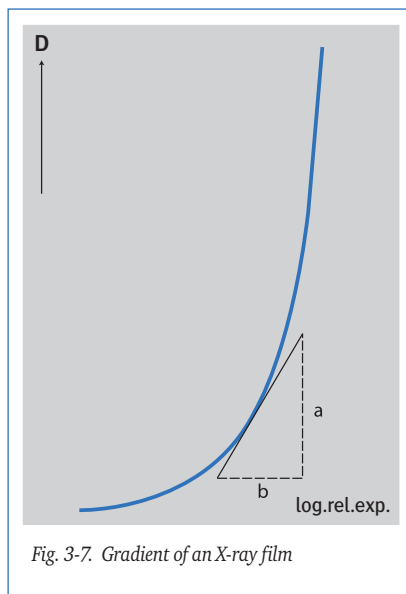

### Average gradient

The straight line connecting two points on a characteristic curve, as figure 4-7 shows, is equal to the “average gradient” of the segment of the curve linking these two points. This gradient ( $G_D$ ) is the average of all gradients in the segment between density values 3.50 and 1.50, and is a standard characteristic of a particular type of radiographic film.

In all films (for example D2 through to D8) the gradient ( $a/b$ ) increases with increasing density within the for conventional viewing screens useful density range of  $D < 5$ .

The various types of films are not identical. This becomes clear if plotting the values of gradient  $G_D$  against the density resulting in the gradient/density curves, as shown in figure 5-7. At higher film sensitivity the gradient is lower and, hence, the density curve less steep.

A steeper gradient means an increase in density difference at equal radiation dose and so a greater contrast, resulting in better defect discernibility. If one requires high contrast, it is therefore necessary to use the highest possible density radiograph, while remaining within the acceptable density range of the viewing screen so as not to impede film interpretation.

Most codes of good practice ask for densities between 2.0 and 3.0 in the relevant area of the image.

Table 1-7 shows the loss in contrast on typical film as density values obtained fall below 3.0 .

Density D	Film contrast as a % of the value at
D = 3.0	
3.0	100
2.5	85
2.0	71
1.5	54
1.0	35

Table 1-7. Contrast loss with reduced film density

The specimen in figure 6-7 containing a small step is radiographed with an exposure time resulting in a density difference of 0.5 (B minus A). If now, using the same type of film and the same tube voltage, a longer exposure time is given, the density difference is 0.9 (D minus C). The second radiograph, therefore, shows more contrast.

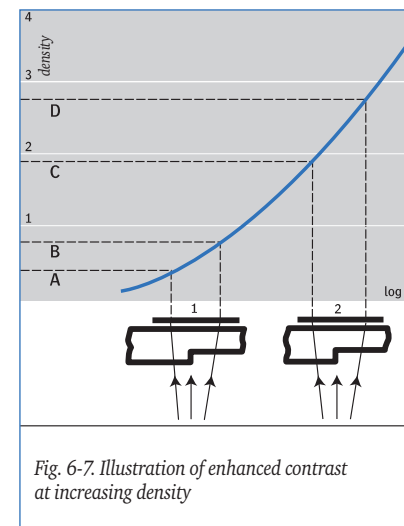
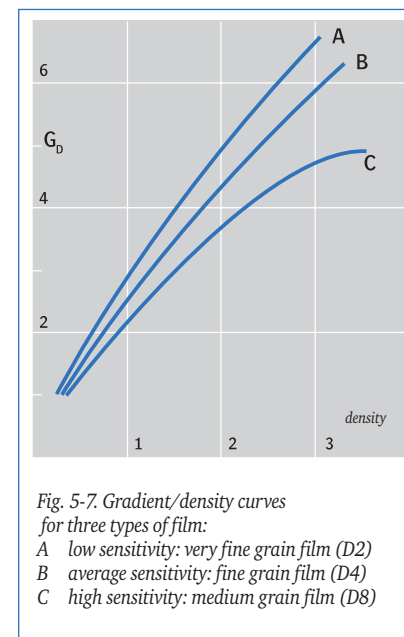

### Effect of developing conditions on the density curve

The characteristic curve of an X-ray film is not only determined by the emulsion characteristics but also by the way the film is developed. Parameters which can influence the characteristic curve are: developing time and its temperature, developer concentration and agitation.

The effect of, for example, the developing time on speed (relative exposure factor), contrast and fog, has been made visible in figure 7-7. Initially, up to approx. 4 minutes, speed and contrast are low but increase rapidly with developing time.

From 8 minutes on, a further increase in developing time increases the background fog, and eventually a decrease in contrast will occur.

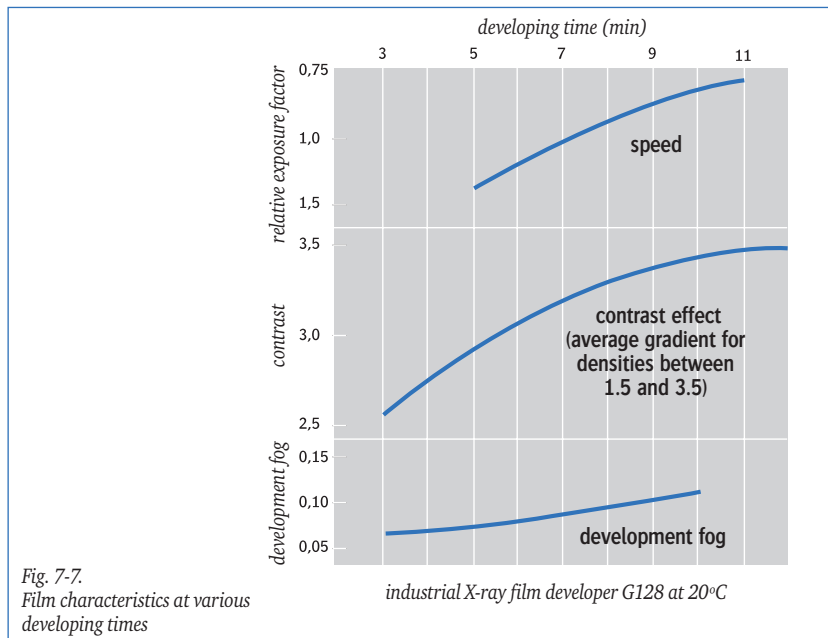

Fig. 7-7.  
Film characteristics at various developing times

Although it is possible to compensate, to a certain extent, for minor variations from the correct radiation exposure by adapting the developing time, normally a fixed time is maintained. In manual developing the standard time is 5 minutes. Developer type, film agitation in the tank and temperature also influence density. That is why the overall developing process should preferably be standardised or automated. In most cases, deviating from the optimum developing conditions leads to reduced image quality.

### 7.5 Film speed (sensitivity)

In radiography the relationship between exposure (in C/kg) and resulting density is commonly referred to as film speed. Other than in normal photography where film speed is indicated by a DIN or ASA number, films for industrial radiography do not carry an internationally recognised speed number.

The generally accepted method of measuring the film speed of radiographic films is to measure the exposure required to achieve a density of 2.0 above base and fog, using a specific processing technique. The various relative exposure values are shown in table 1-8.

### 7.6 Graininess

When a developed X-ray film is viewed in detail on an illuminated screen, minute density variations are visible in a grainy sort of structure. This visual impression is called “graininess” and a measurement of this phenomenon establishes a degree of “granularity”.



Industrial X-ray films are produced by a limited number of manufacturers in an assortment for use with or without intensifying screens and filters. The selection of a particular film type not only depends on economics but in particular on the required, often prescribed, image quality.

### 8.1 The Agfa assortment of film types

The films produced by Agfa are exclusively marketed world-wide by GE Inspection Technologies. The assortment of industrial standard radiographic film comprises the following types in sequence of increased speed and granularity : D2, D3, D4, D5, D7 and D8, complemented with the very fast films F6 and F8.

The ultra-fine-grain D2-film is used in the radiography of very small components, when optical magnification is applied to allow very fine details to be observed. D3 also exists as D3 s.c. (single coating) as alternative for D2 and is extremely suitable for optical enlargements in case of very small components which require large magnification factors of the image. Moreover this type of film is suitable for neutrography, see section 17.5. D8 is used for the examination of big castings and steel reinforced concrete. D10 film is also produced for exposure monitoring purposes, see section 19.6. Figures 1-8 and 2-8 show the relationship between film speed and image quality and film contrast respectively.

In addition to these graphs, figure 27-16 gives a graphical representation of relative image quality as a function of relative dose and exposure time (film speed) for D-films and computer-assisted CR and DR techniques.

Agfa has developed special intensifying screens specifically for use in combination with F6 and F8 films, see section 6.3. These so-called rapid cycle film screens are usually referred to as RCF-screens indicated as Agfa NDT1200. F8 has the highest film speed. Depending on quality requirements, F6 is mostly used for weld inspection on lay barges and on-stream application (profile radiography); since it shortens examination time by a factor 10, see section 6.3. This combination can also be used for (hand held) flash radiography to enable lowest possible dose to make a quick but nevertheless suitable image.

Film and screens are available in a wide variety of sizes and packings. For example as separate items to create a specific combination of film and screen or fully prepared for the job in daylight packing including lead screens and evacuated (Vacupac) to guarantee the best possible contact between film and screens. Films with screens are available on a roll (Rollpac) to cut suitable lengths, or even precut at a specified length for large jobs which require large numbers of identical film lengths, e.g. for girth weld inspection of long distance pipelines. Last but not least films can be made in sizes on customer demand.

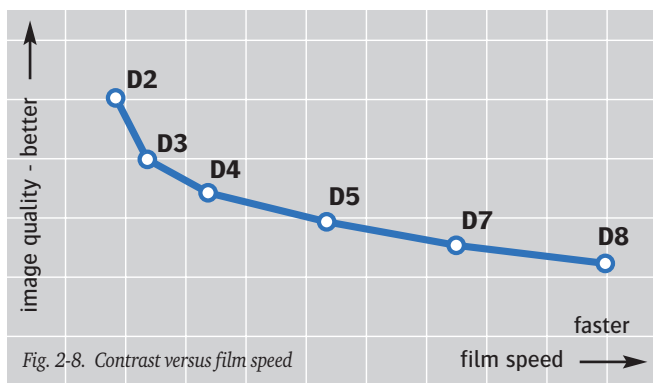
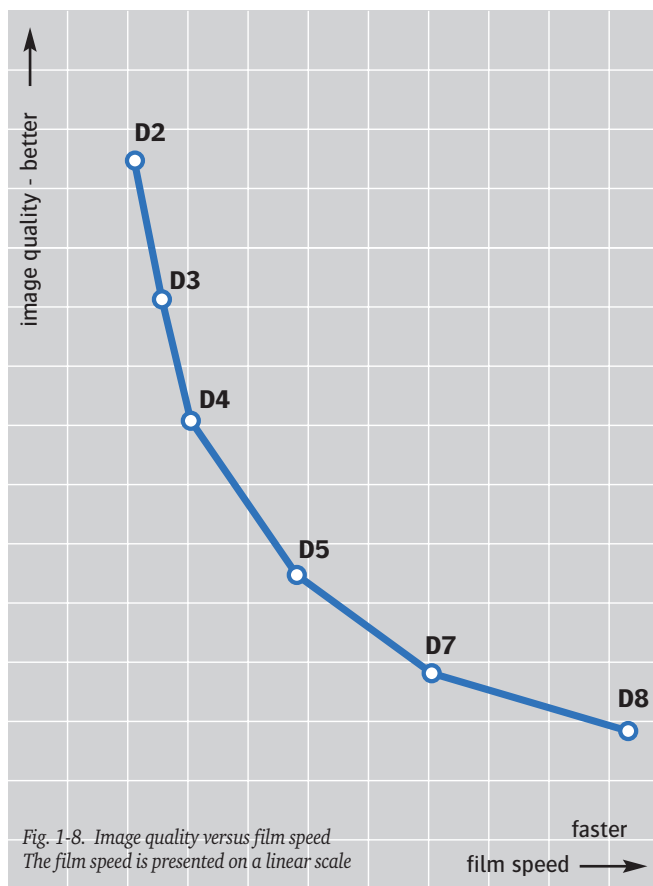
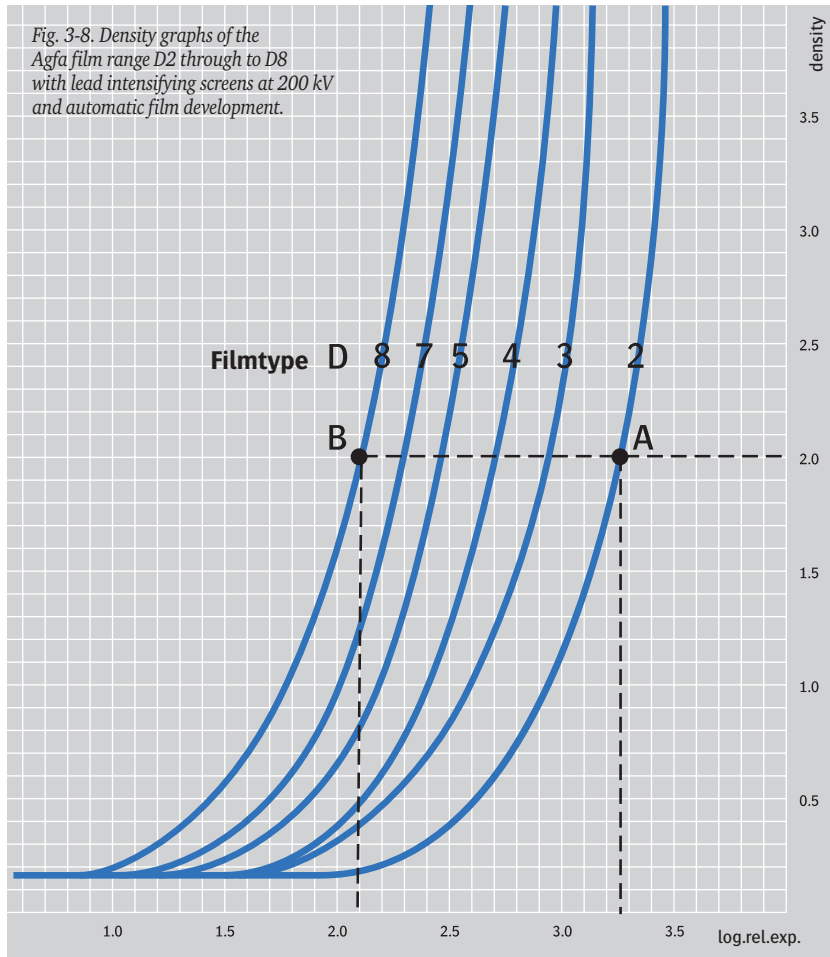

Figure 3-8 shows graphs of relative exposure time versus density for the entire Agfa D-film range. For density 2, the difference between a D8 and a D2 film is a factor 14 ( $10^{(3.25-2.1)}$ ), at 200 kV.



Note: Developing process for figure 3-8 above:  
Automatic, 8 min cycle, 100 seconds immersion time in developer G135 at 28 °C.

Part of the Agfa film range with relative exposure factors and code classification has been listed in table 1-8 for various radiation intensities :

Film type	Relative exposure factors					Film system Class	
	100 kV (1)	200 kV (2)	300 kV (3)	Ir192 (4)	Co60	EN 584 -1	ASTM E 1815
D2	9.0	7.0		8.0	9.0	C1	Special
D3	4.1	4.3		5.0	5.0	C2	1
D4	3.0	2.7		3.0	3.0	C3	1
D5	1.7	1.5		1.5	1.5	C4	1
<b>D7</b>	<b>1.0</b>	<b>1.0</b>	<b>1.0</b>	<b>1.0</b>	<b>1.0</b>	C5	2
D8	0.6	0.6		0.6	0.6	C6	3
F6+RCF (5)	0.174		0.132	0.389	0.562		
F8+RCF (5)	0.03		0.022	0.035	0.040		

Table 1-8.  
Listing of various Agfa films and their relative exposure factors and film system classification

Note I: It is common practice to compare relative exposure factors with those of D7 film, which are shown bold as reference value 1.0 in the table.

Note II: The numbers (1) to (5) used in the table indicate the use of the following screen types:

- 1 without lead screens
- 2 with lead screen 0.027 mm thickness
- 3 with lead screen 0.027 mm thickness
- 4 with lead screen, front 0.10 mm, back 0.15 mm thickness
- 5 with fluorometallic screen (RCF)

Note III: Developing process for table 1-8: automatic, 8 minute-cycle, 100 seconds immersion time in developer G135 at 28 °C.

Note IV: The relative exposure factor depends not only on radiation intensity, but also on exposure time and is, therefore, not a constant value.



## 8.2 Film type selection

---

Most procedures and codes of good practice for the performance of industrial radiography base the choice of type of film for a specific application on the EN or ASTM classification systems. For weld inspection, when one is attempting to detect small cracks, a film of class C2 or C3 would be specified. For the examination of castings or general radiography a film of class C4 or C5 would normally be used. For small component inspection, where the image might be viewed under magnification to reveal small details, a film of class C2 or possibly even a single emulsion film of class C1 would be desirable.

In megavoltage radiography, because most equipment have a very high radiation output, class C3 films can be used for objects of great wall thickness. This has the advantage that a high film gradient can be achieved.

## 8.3 Film sizes

---

Film sizes in industrial radiography are to a large extent standardised according to ISO 5565. Non-standard sizes are possible. Standard film sizes and metal screens are supplied separately, but can also be supplied vacuum-packed so that the risk of film faults is considerably reduced. For weld inspection there is so-called Rollpac film strip on the market which is available on a roll together with the lead screen. For very large projects the strip film can even be pre-cut to suit a particular weld length or pipe/vessel circumference.

## 8.4 Handling and storage of unexposed films

---

The conditions under which unexposed films are handled and stored play a very important role in the final quality of the exposed film. Recommendations for handling and storage are contained in, for example, ASTM E1254. "Pre-exposure" as a result of background radiation must be avoided as it causes unacceptable fogging of the film.

If films are to be kept for a longer period, the following storage conditions must be adhered to:

- background radiation levels below 90 nGray
- temperatures below 24 °C
- relative humidity levels below 60 %
- away from X-ray film chemicals
- preferably stacked on edge

In the long run, minor fogging will occur to films stored. Background fog to a maximum density of 0.3 is considered acceptable.





*X-ray photograph of a Van Gogh painting, presumably a self-portrait, on canvas.  
X-rays are made to prove a paintings authenticity, check the condition of the canvas material,  
or determine possible paint-overs.  
Cadmium and/or lead in the paint absorb radiation, thus forming an image.  
Applied X-ray process data: 30 kV, 10 mA.min, Agfa D4 without lead screens and a source-to-film  
distance of 100 cm.*

### 9.1 Exposure chart parameters

Codes for the inspection of welds and castings specify the maximum allowed radiation intensity, based on the type of material and the thickness of the object. Exposure charts are necessary to establish the correct exposure value. A universal exposure graph or slide-rule can be used for radioactive sources, as these have a fixed natural radiation spectrum.

The radiation spectrum of X-ray tubes varies with each tube, even if they are of the same type. This problem is easily solved by using a universal exposure chart for the specific type of tube, and then individualise it for each tube, the so-called “curve fitting”. The adaptation is normally limited to a zero-point correction, based on a few measured values obtained by trial. Sometimes the gradient of the exposure graph needs to be adjusted as well.

An exposure chart is produced by making a series of radiographs of a step wedge as illustrated in figure 1-9.

The radiation intensity level of most X-ray equipment is expressed by the amperage of the current through the X-ray tube, measured in milliamperes (mA). The exposure (radiation dose) is specified as the product of radiation intensity and exposure duration in mA.min. (intensity x time).

The exposure chart shows the relationship between the thickness of the object (in mm) and the exposure value (for X-ray tubes in kV and mA.min; for sources in GBq/h).

The exposure chart is applied for:

1. a given density, for example: 2 or 2.5
2. a given film-screen combination, for example D7 with lead screens
3. a given type of material, for example steel

The chart depends amongst others on:

4. type of X-ray equipment or radioactive source
5. source-to-film distance, usually 800 mm
6. development conditions, for example: automatic, 8 minutes at 28°C.



### Type of X-ray equipment

Among the factors to be taken into account are: the voltage (in kV), whether alternating or direct current, the limits of voltage adjustment and the current through the tube (in mA). It follows that the exposure chart is unique for a particular X-ray set.

### The radioactive source

Radiation intensity and half-life-time of the source have to be taken into account.

### Source-to-film distance

The exposure chart for an X-ray set is produced for a specified source-to-film distance. If another distance is used, corrections will be necessary, using the inverse square law.

### Intensifying screens

When drawing up the exposure chart, intensifying screens used must be recorded and the same type of screens used again when making radiographs.

### Type of film

The type of film must be indicated on the exposure chart, since the various types of industrial X-ray films are substantially different in sensitivity (speed).

### Density

An exposure chart must be as accurate as possible. Densities indicated are to be measured by a densitometer, see section 9.2. The radiographs that form the basis for the chart must have been made under controlled and reproducible conditions, whereby quality monitoring tools such as PMC strips as described in section 10.6 are used.

### Developing process

Developer formula, processing temperature and developing time all influence the final result. The exposure chart produced will be related to a particular well-defined developing process.

## 9.2 Densitometer

A densitometer is used to accurately measure the photographic (optical) density at any spot on a radiographic film. For most types of densitometers the size of the measured area is approx. 1 mm<sup>2</sup>. The measuring range runs from density 0 to 4.

Since it is a logarithmic scale, this equals a factor 10,000 (10<sup>4</sup>) in density.

It is very important to regularly recalibrate these instruments, particularly around values 2 and 2.3, since those are the minimum densities (depending on class: A or B) which a film must have in accordance with standard EN 444, to allow it to be interpreted.

Densitometers are supplied with reference material (density strips) to re-calibrate them. Regular recalibration, at least once a year according to code, is essential.

The most commonly used density strips deteriorate quickly as a result of scratching and disintegration of the sealed transparent wrapping in which they are usually kept.

Their service-life, depending on use, is usually not much longer than six months. Agfa has developed the “Denstep” density step wedge film and has succeeded in considerably extending the service-life of these strips by supplying them in special wear proof wrapping.

These density strips are certified and have a guaranteed minimum service life of four years. The 15 steps of the “Denstep” comprise a density range from 0.3 to 4.

## 9.3 Producing an exposure chart for X-rays

### The step wedge

The production of an exposure chart calls for either a large step wedge or a series of plates of different thicknesses made from the same material to which the chart relates. The increase in thickness between each consecutive step is constant, but varies for different materials from 0.5mm to several millimetres.

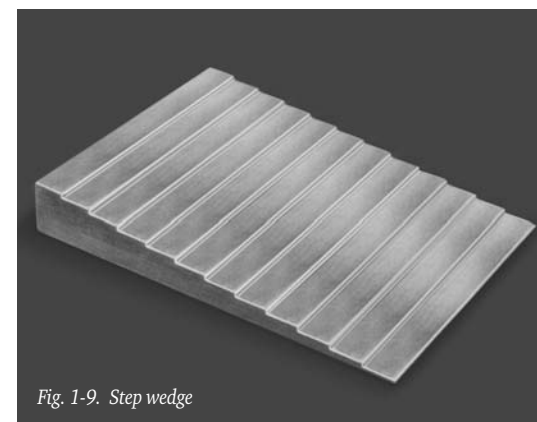

For examinations using a tube voltage of less than 175 kV the thickness of the wedge might increase by 0.5 or 1.0 mm at each step, while for radiographs using a higher tube voltage the increase could be in the order of 2-3 mm. In addition several flat plates made from the same material and of a specified thickness (e.g. 10 mm) should be available.

If the thickness range of a step wedge runs from, say, 0.5 to 10 mm, the step wedge and flat plate together would give a thickness range of 10.5 – 20 mm



### Preliminary charts

Before producing an exposure chart it is useful to first draw up preliminary charts, the so-called “density-thickness chart” for the voltage range of the specific X-ray set and a “kV- thickness chart”.

The two preliminary charts are produced on the basis of the following data:

1. X-ray set: tube voltage 60-200 kV, tube current 5-10 mA
2. Filter: none
3. Source-to-film distance: 80 cm
4. Material: steel
5. Intensifying screens: none
6. Type of film: D7
7. Density: 2.0
8. Development: automatic, 8 minutes at 28°C in G135 developer

### Exposures

Using a tube current of say 8 mA and an exposure time of 1 minute (i.e. 8 mA.min) radiographs of the step wedge are made at voltages of, for example 75, 90, 105, 120, 135, 150, 165, 180 and 195 kV. Only a narrow strip of the film is used for each exposure. The same process is repeated at, say 10 mA with an exposure of 20 minutes (i.e. 200 mA.min).

### Measuring the density

After development of the radiographs, the density of all steps is measured by a densitometer, see section 9.2.

### Drawing up the preliminary charts

The densities measured are plotted graphically against the material thickness for which they were obtained. A smoothly curved line then joins the points relating to one particular voltage. The result is two preliminary charts (figure 2-9), made at 8 mA.min and 200 mA.min.

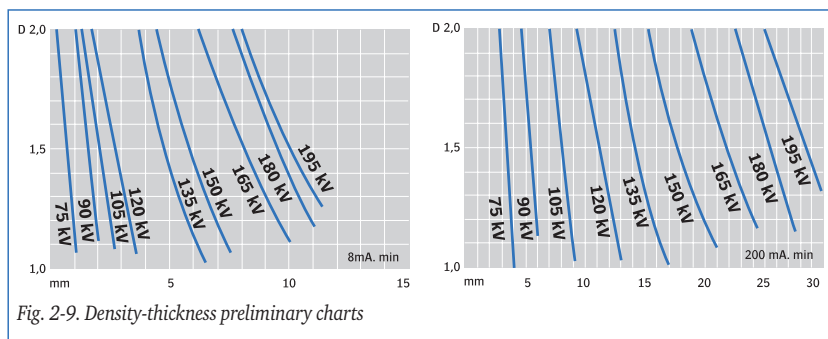

Fig. 2-9. Density-thickness preliminary charts

The “density-thickness (preliminary) charts” as described, provide the data needed to prepare the final exposure chart. In order to eliminate any inaccuracies, an intermediate chart (based on the preliminary charts) is prepared for density 2, using the data already recorded in the first charts.

This is how the “thickness-tube voltage chart” of figure 3-9 is arrived at. Points relating to the same series of exposures are then joined in a smooth line producing the intermediate curves for 8 mA.min and 200 mA.min. In this way deviations in the results of any of the radiographs can be compensated for.

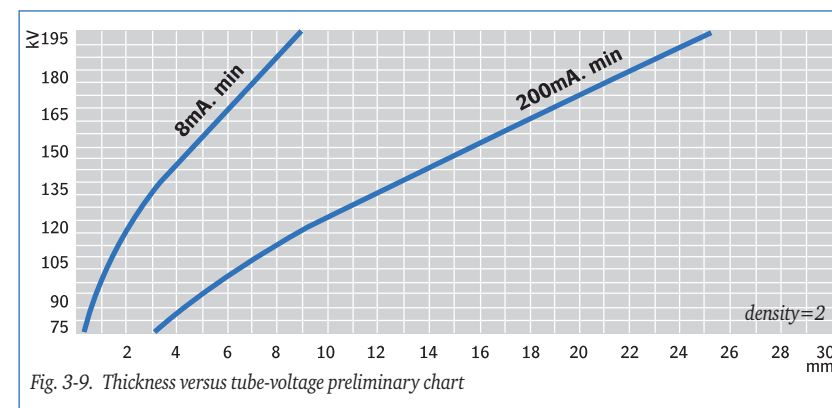

Fig. 3-9. Thickness versus tube-voltage preliminary chart



## 9.4 The exposure chart

The exposure chart should be drawn on uni-directional logarithmic paper. The material thickness (in mm) is plotted on the horizontal linear axis and the exposure value (in mA.min) on the vertical logarithmic axis. For a given kilovoltage (for example 150 kV), we can, using the previously described intermediate kV-thickness chart, determine that for an exposure dose of 8 mA.min a density of 2 can be obtained at a thickness of 4.5 mm and for an exposure dose of 200 mA.min, at a thickness of 15.2 mm.

These thicknesses, and the corresponding exposures, are then plotted on the graph paper to give points A and B, see figure 4-9. Drawing a straight line linking points A and B, the 150 kV line is obtained. In a similar way the lines for other kV-values can be drawn in the diagram, eventually resulting in the complete exposure chart of figure 4-9.

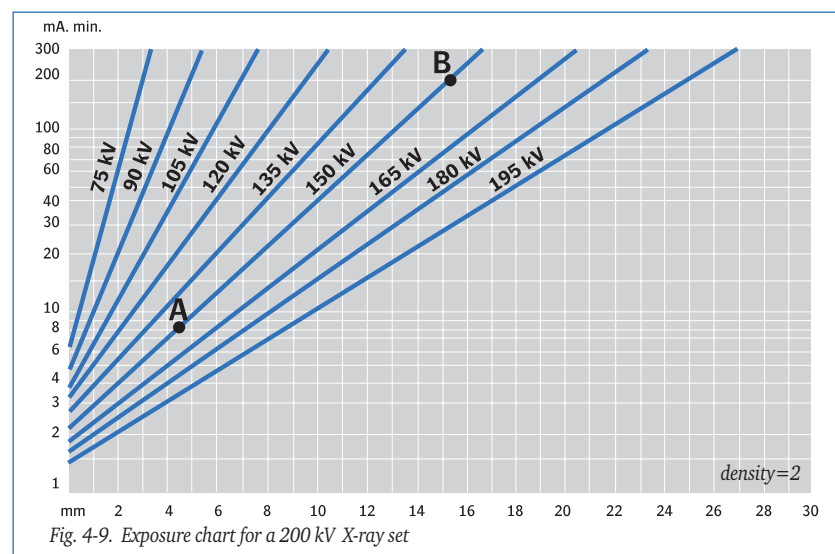

## 9.5 Use of the exposure chart

While it may be possible to gradually build up a store of information which can be consulted in day-to-day work, it is better to make use of good exposure charts. This system has many advantages to offer, particularly when it comes to choosing the most suitable working method. Apart from saving time, it gives a guarantee of efficiency and moreover does away with, or reduces to an acceptable extent, the need for trial exposures on jobs which are a little outside the normal routine.

Different X-ray tubes can in practice give quite different results, even though they may be of the same type. Even a different cable length between the control panel and the tube may be of influence.

Therefore, an exposure chart for each individual X-ray set should be drawn up. This is an excellent way to become familiar with the equipment, while time and money put into this work will be amply repaid at a later stage.

Exposure charts for gamma-ray examination are drawn up in a similar way as described above. Figure 5-9 shows one for a Cobalt60 source. A specially designed slide-rule can also be used, since there is no need to consider individual radiation spectra as for X-ray tubes. Figure 6-9 shows a similar exposure chart for an Iridium192 source.

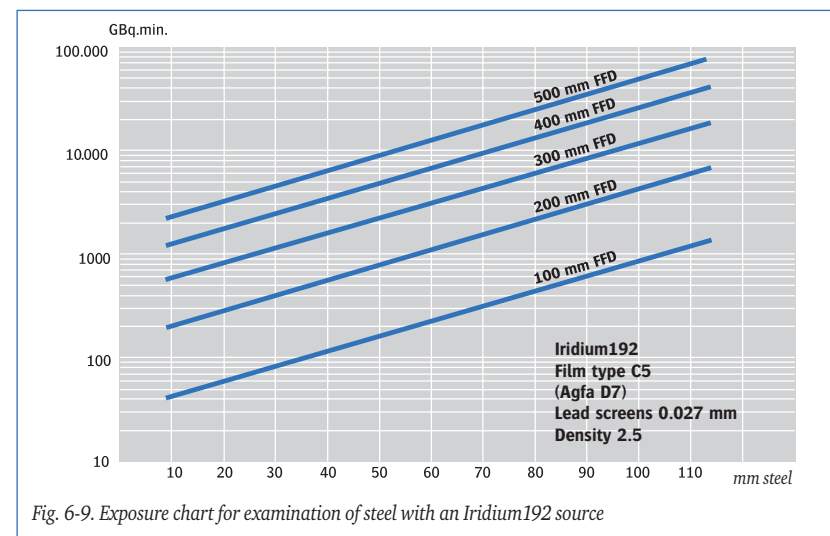
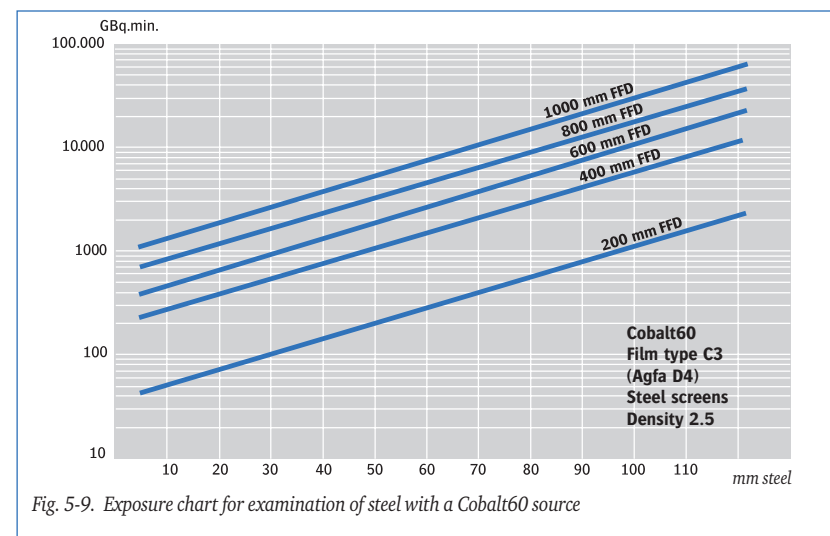

FFD = focus-to-film distance



## 9.6 Relative exposure factors

“Relative exposure factors” can be used to convert an exposure chart for one type of film to another film, although still for the same radiation energy.

These factors are not constant for different radiation energies and should, therefore, be used with some caution. Some examples of relative exposure factors for Agfa films are shown in table 1-9.

These are the factors by which to increase or decrease the exposure-time when using the types of film other than those for which the exposure charts have been prepared. In view of the widely-varying quality of the radiation emitted by different types of X-ray equipment and the appreciably different characteristics of the various types of X-ray films made for industrial use, caution should be exercised in applying these relative exposure factors generally.

Type of film	Relative exposure factors				
	100 kV (1)	200 kV (2)	300 kV (3)	Ir192 (4)	Co60
D2	9.0	7.0		8.0	9.0
D3	4.1	4.3		5.0	5.0
D4	3.0	2.7		3.0	3.0
D5	1.7	1.5		1.5	1.5
D7	1.0	1.0	1.0	1.0	1.0
D8	0.6	0.6		0.6	0.6
RCF+F6 (5)	0.174		0.132	0.389	0.562
RCF+F8 (5)	0.03		0.022	0.035	0/040

Table 1-9. Relative exposure factors. For (1) to (5) refer table 1-8.

Darkroom technique too, plays an important role and a uniform manual or automatic development process is, therefore, essential.

With radioactive sources, which give a constant quality (hardness/energy) of radiation, the relative exposure factors listed can be used quite safely.

## 9.7 Absolute exposure times

Table 2-9, derived from reference [2], lists the widely varying absolute exposure times when different radiation sources are used for radiography on steel of varying thickness. The relative exposure factors from table 1-9 for both types of film can be recognised in this table.

Energy	X-ray tube						Gamma source			Linac
	100 kV	250 kV	300 kV		450 keV	1,25 MeV	8 MeV			
mA	3	10	10							
Exp. C/Kg.s					1.8	4.7	5000			
FFD. mm	500	700	700		1000	2000	2000			
Film type	D4	D7	D4	D7	D4	D7	D4	D7	D7	
Mat.thickness	Exposure time in seconds									
15 mm	50	10								
25 mm			100	20	70	15	80			
50 mm			1080	210	660	210	6300	1980	1680	
100 mm								6300		
150 mm								32400	10	
200 mm									30	
400 mm									4200	

Table 2-9. Absolute exposure times for steel of varying thicknesses, derived from [ref. 2]

## 9.8 Use of the characteristic (density) curve with an exposure chart

In the following examples the tube voltage and focus-to-film distance (FFD) are assumed to be constant, and automatic development is for 8 minutes in G135 developer at 28°C.

### Example 1:

*Effect of the thickness of the object on the density of the radiographic image*

It is required to radiograph, on D7 film, a steel object comprising two sections of different thickness of 12 mm and 15 mm. The exposure chart figure 7-9 shows that at 160 kV and an FFD. of 70 cm, using 10mA.min, a density of 2 behind the section measuring 15 mm in thickness will be obtained.

**Question:** What image density will be obtained behind the section measuring 12 mm under these given conditions?

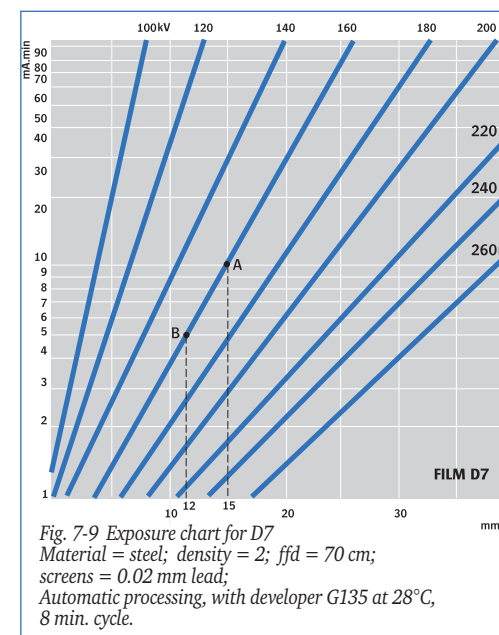

Fig. 7-9 Exposure chart for D7  
Material = steel; density = 2; ffd = 70 cm;  
screens = 0.02 mm lead;  
Automatic processing, with developer G135 at 28°C,  
8 min. cycle.



**Method and answer**

The exposure chart (fig.7-9) shows that under the conditions mentioned above density  $D = 2$  is obtained on D7-film through the 15 mm thick section, using an exposure of 10 mA.min, point A on the chart.

Under the same conditions the 12 mm section would require an exposure of 5 mA.min (point B in the chart), which means an exposure ratio of 10/5.

The exposure through the 12 mm section is two times greater than through the 15 mm section.

The logarithm of this ratio equals:  $0.3$  ( $\log 2 = 0.3$ ).

The characteristic curve (fig. 8-9) of the D7-film shows that density 2 corresponds to log relative exposure 2.2 (point C in fig. 8-9).

At 12 mm the log. rel. exposure is  $2.2 + 0.3 = 2.5$ .

The corresponding density is then 3.5 (point D in fig. 8-9)

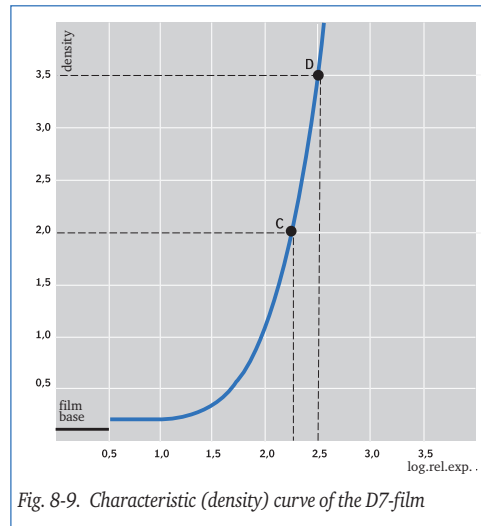

Fig. 8-9. Characteristic (density) curve of the D7-film

**Example 2:**

**Effect of exposure on contrast**

Assume that when an exposure of 15 mA.min is used for a radiograph on D7-film, both average density and contrast prove to be too low after processing. The highest and lowest density in the most relevant section of the image are only 1.5 and 0.5.

The intention was to make a radiograph with a maximum density of 3.0.

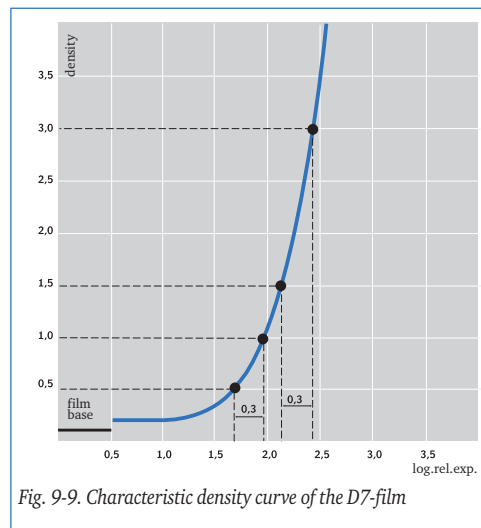

Fig. 9-9. Characteristic density curve of the D7-film

**Questions:**

What exposure time would be required for the same radiation intensity and what contrast increase would be achieved?

**Method and answer**

The characteristic curve (fig. 9-9) shows that at the measured densities of 1.5 and 0.5 respectively, the corresponding logarithm of relative exposures are 2.15 and 1.65.

Since density 3.0 should not be exceeded, the area which is most important for interpretation, which showed density 1.5 on the first exposure, must now display 3.0. Characteristic curve, figure 9-9, shows that density 3.0 corresponds with log.rel.exp. 2.45 and the difference between the two values amounts to  $2.45 - 2.15 = 0.3$ .

This means that the exposure time must be doubled ( $10^{0.3} = 2$ ), resulting in a radiation dose of 30 mA.min. This answers the first question.

If the exposure time is doubled, the log.rel.exposure of the lowest density value originally measured will increase by 0.3, i.e.  $1.65 + 0.3 = 1.95$ . The corresponding density will be 1.0 (fig. 9-9).

The average gradient between the upper and lower densities on the original radiograph was  $(1.5 - 0.5) / (2.15 - 1.65) = 2.0$ .

The average gradient on the new radiograph is  $(3.0 - 1.0) / (2.45 - 1.95) = 4.0$ , so the average contrast has doubled.



## 10 Processing and storage of X-ray films



Preparation for an X-ray exposure of a painting by Rembrandt

Film developing is the process by which a latent image, see section 7.2, is converted into a visible image. The crystals in the emulsion - carriers of the silver traces forming the latent image - are transformed into metallic silver by selective reduction as a result of which the visible image is created. The development procedure must be carried out carefully to achieve this and guarantee successful archiving over a longer period. Manual developing is a laborious process that must be carried out meticulously in order to get the high quality results.

For increased efficiency and uniform quality, X-ray films are more commonly processed automatically. The manual process is, however, still frequently applied. It will therefore be useful to describe manual processing in this chapter and so become familiar with the developing process.

### 10.1 The darkroom

#### Entrance and colour

For practical reasons the darkroom needs to be as close as possible to the place where the exposures are made, although naturally out of reach of radiation.

The darkroom needs to be completely lightproof, so the entrance must be a “light-trap” usually in the form of two doors, (one after the other), a revolving door or a labyrinth.

In practice the labyrinth is found to be the best arrangement, although it does take up a comparatively large space. The walls of the passage are painted matt black, and a white stripe about 10 cm wide running along its walls at eye-level is enough as a guide. Inside the darkroom itself, the walls should preferably be painted in a light colour; light walls reflect the little light there is and are easier to keep clean.

#### Darkroom lighting

X-ray films are best-processed in normal orange-red (R1) or green (D7) darkroom lights. The distance between film and darkroom lighting needs to be considered, depending on the sensitivity of the film and the duration of the development process.

The “light safety” of the darkroom lighting can be tested by covering half of a pre-exposed film (density 2) lengthways, leave it for 5 minutes and then process it as usual. The difference in density may not exceed 0.1.



Another method is to place an unexposed film on the workbench and cover part of it up with a sheet of cardboard, which is then gradually removed so as to produce a series of different exposures. By developing the film in the usual way, it will then be possible to see how “safe” the light is, and how long a film can be exposed to it before it exceeds the maximum acceptable difference in density of 0.1.

### Darkroom layout

The darkroom should preferably be divided into a dry side and a wet side. The dry side will be used for loading and emptying cassettes, fitting films into developing frames and so on - in short, for all the work that does not allow dampness.

On the wet side, the films will be processed in the various tanks of chemical solution. For efficient working, and to ensure uniform quality, there should be automatic control of the temperature of the solutions.

### Tanks

In processing tanks used in the manual process, films are held vertically in their frames. These tanks can be made of stainless steel or plastic. The dimensions of the tank must be suited to the size and number of films to be processed. There must be a space of at least 1.5 cm between films. The top edge of the films must be approx. 2 cm below the surface of the solution.

The wet side of the darkroom will have five tanks, arranged in the following sequence:

1. developer tank
2. stopbath or rinse tank
3. fixer tank
4. final wash tank
5. tank for wetting solution

## 10.2 Chemicals and film-development

### Making-up processing solutions

Nowadays, chemicals are supplied as a liquid concentrate, suitable for the particular type of film used.

The processing solutions can be prepared either directly in the tanks or in plastic buckets. In the latter case each type of solution must be prepared in a separate bucket, which is never used for other chemicals.

### Developer

Development fog, graininess and contrast are dependent on the type of developer, which is preferably made up to suit the film used.

If a concentrated manual developer is used, for example G128 made by Agfa, and the developer tank has a capacity of, say, 25 litres, then all to do is pour 5 litres of the concentrated developer into the tank and add 20 litres of water (ratio 1 part of concentrate to 4 parts of water). G128 developer is also used as a replenisher, in which case 3 parts of water are added to 1 part of concentrate.

### Fixer

Fixer too is supplied as a concentrated liquid (G328). The same instructions as for preparing developer apply here.

### Developing times and bath temperatures

The film is clipped on or slipped into a frame, depending on the type of frame, and hung in the developer tank. As soon as the film is submerged in the developer, the darkroom timer is set for the required number of minutes. The optimal developing time is the time at which the most favourable “contrast to fog ratio” is achieved. Minor deviations from the correct exposure time may be compensated by adjusting the developing time.

The recommended developing time for Agfa films in G128- manual developer is 5 minutes at 20°C. In the automatic process using G135 developer, the developing time is 100 seconds at 28°C. Deviating from the recommended developing times and temperatures will almost always lead to reduced image quality (e.g. increased coarse-graininess).

Raising the tank temperature will speed up the development process as table 1-10 shows, but the developer will oxidise more rapidly. Should it not be possible to achieve a bath temperature of 20°C, the following developing times can be used at the temperatures as indicated in table 1-10. This applies to all D-type films.

Temp. °C	18	20	22	24	26	28	30
Time/mins	6	5	4	3.5	3	2.5	2

Table 1-10. Developing time versus developer temperature.

The temperature of the developer shall never be less than 10°C, but is preferably higher than 18°C to obtain optimal image contrast. It is best to always maintain the same developing conditions, so that the exposure technique can be matched to these and uniform results obtained.



### Film agitation

To prevent air bubbles from forming on the surface of the emulsion (which will cause spots on the finished radiographs), and to make sure that the developer penetrates all areas of the emulsion evenly, the films should be kept moving during their first 30 seconds in the developer. After that, it is recommended to move the film from time to time to prevent film faults such as lines or streaks.

### Replenishing

Up to 400 ml of liquid per square meter of film processed may be carried over to the next tank. When developing frames used it is, therefore, preferable to hold the film 2-3 seconds over the developer tank to drip.

After each square meter of film developed, 600 ml of replenisher must be added to the bath regardless of the quantity of developer lost from the tank. Up to about 4 litres of replenisher can be added in this way, for every litre of the original developer in the tank. The solution must be discarded and replaced with fresh developer when the total quantity of replenisher added is three times the original total contents, but in any case after eight weeks, irrespective of the number of X-ray films processed.

### Stopbath

Before transferring the developed film to the fixer tank, it is placed in a stopbath (consisting of 30 ml glacial acetic acid to 1 litre of water) for 30 seconds to prevent the fixer solution from being neutralized too rapidly by the developer, and stripes or dichroitic fog from forming on the film.

If a film is not passed through a stopbath, it must be rinsed in running water for a few minutes immediately after leaving the developer.

### Fixing

Fixing renders the image formed during development permanent, by removing undeveloped silver halide salts from the emulsion. When the film is taken from the stopbath it still has a milky appearance; this changes in the fixer and the light areas of the film become transparent.

As a rule the film is left in the fixer twice as long as it takes to “clear” or become transparent. Fixing time (in a fresh solution approx. 3 minutes) is twice the clearing time (1.5 min.). As soon as it takes double that time to “clear” a film in G328 fixer solution at 20°C, it must be replaced.

For every liter of solution in the fixing tank, a square meter of film can be treated.

Films have to be kept moving during the first 30 seconds in the fixing bath.

### Final wash

The final wash is intended to remove the residual fixer and the soluble silver compounds left behind in the emulsion, which if not flushed out, would reduce film shelf life. Washing should preferably be done with running water, ensuring that all parts of the film are reached by fresh water. The duration of the final wash depends on the temperature of the water. See table 2-10. Temperatures over 25°C must be avoided.

Temperature range (°C)	Washing time (minutes)
5-12	30
13-25	20
26-30	15
> 30	10

Table 2-10. Relationship between water temperature and washing time

### Drying in the drying cabinet

When the film is taken out of the water, the water on the film, as a result of its surface tension, runs together to form droplets of varying size. The film will, therefore, dry unevenly, causing “drying marks”. For this reason it is advisable to immerse the films in a solution of 5-10 ml wetting agent to each litre of water. Wetting agent reduces the surface tension of the water so that, after the film has drained, the surface will be evenly wetted and will dry evenly with no risk of marks. Films should be hung to drain for about 2 minutes before they are placed in the drying cabinet.

Drying should preferably be done in a drying cabinet, or alternatively in a dry and dust free room. No drops of water must be allowed to fall on films that are already drying, as this will cause marks. Wet films should, therefore, always be hung below already drying films.

Drying time will depend on temperature, air circulation and relative humidity of the air in the cabinet. Films will dry more quickly when they have first been put into a wetting agent.

Before a film is taken out of the drying cabinet, it must be checked that the corners and edges of the film are thoroughly dry. Air temperatures above 40°C should be avoided as this may cause ugly drying marks. There must be free circulation of air between the films in a cabinet; if they cannot dry evenly on both sides, they may curl or distort.

### Roller dryers

Industrial dryers can be used to dry films quickly and uniformly after washing. This mechanised drying process only takes minutes. Dryers and chemicals should preferably be matched. There are compact roller dryers on the market which are capable of developing approx. 15 cm of film per minute and take up far less space than a drying cabinet.



## 10.3 Recommendations for the darkroom

---

### *Cleaning of tanks*

Whenever the processing solution is renewed the tank must be cleaned, preferably with hot water and soap. If this proves inadequate, polyester tanks can be cleaned using a bleach solution (100-200 ml/litre of water), hydrochloric acid (10 ml/litre of water) or acetic acid (50 ml/litre of water). Stainless steel tanks may be cleaned with a solution of nitric acid (10 ml/litre of water) or acetic acid (50 ml/litre of water). Hydrochloric acid must never be used for stainless steel tanks.

There are industrial cleaning agents on the market (for example Devclean and the, environment-friendly, Fixclean), specially developed for cleaning of darkrooms.

### *Stained fingers*

Brown stains on the fingers can be avoided by rinsing the hands in water whenever they come into contact with developer. If fingers do become stained, they should be immersed in a solution of:

- a. 1 litre of water
- b. 2 gr of Potassium-permanganate
- c. 10 ml of concentrated sulphuric acid
- d. Next the hands should be rinsed in an acid fixer solution, and finally washed with soap and water.

### *Chalky water*

If hard, chalky water is used for mixing the solutions, troublesome processing faults may occur. Calcium salts may, in the presence of carbonates and sulphites, result in a whitish deposit on the films which is insoluble in water. To prevent this, the diluant can be softened by using a special filter, or by boiling it first and letting it cool down before making up the chemical solutions.

To remove chalk deposit from films, they may be soaked in a solution of 7 ml glacial acetic acid to a litre of water.

## 10.4 Silver recovery

---

The silver halides in the emulsion which were not reduced during development, are dissolved in the fixer. Silver can be recovered from the fixer in order to keep the silver content of the fixer solution as low as possible so that the fixer lasts two to four times longer, and sell the silver.

Silver recovery can, for example, be done by electrolysis. In addition to electrolysis equipment, there are other silver recovery systems commercially available.

It is worthwhile considering subcontracting this work to a specialised firm in view of secondary aspects such as organisation, logistics, storage and environmental requirements.

## 10.5 Automatic film processing

---

### **NDT-U (universal) film processor**

Over the last few years there has been a vast increase in the use of automatic processors for handling industrial X-ray films. Not only is it a faster and more efficient process, the uniform process also leads to improved image quality. The total processing time may be between 1.5 and 12 minutes (nominally 8 minutes), significantly shorter than in manual processing. Of these 8 minutes, the film will be in the developer solution for only 100 seconds, the so-called "immersion time". These shorter processing times have been made possible by the use of special chemicals (G135 and G335), and by a higher temperature of the solutions: 28°C instead of 20°C.

The shortest processing time of 1.5 minute is essential for the development of the special films used on board lay-barges, where the results must be available quickly.

The chemicals used are more active at higher temperatures. The higher temperature of the solutions makes the emulsion layers swell, resulting in a faster diffusion of the liquid through the layers and, consequently, more rapid action of the chemicals.

Swollen emulsion coatings do, however, have the disadvantage of being softer and hence more vulnerable to damage; a compromise between the advantages and drawbacks is reached by adding a carefully determined proportion of hardening ingredients to the fixer. Chemicals for use in automatic processors also have additives to inhibit oxidation of the solutions and formation of fog in the emulsions.

Automatic film processing not only makes the results available sooner, it also standardises (improved reproducibility/uniformity) the development process and, consequently, the exposure technique. This increases the quality and reliability of radiography as a method of non-destructive testing.

GE Inspection Technologies supplies integrated Agfa-systems in which X-ray films, chemicals and processing equipment are all adapted to each other. Through the uniform characteristics of its films, carefully formulated chemicals, continuous agitation, automatic replenishment and accurate temperature control of the solutions in the processors, Agfa systems ensure top-quality results.

The Agfa NDT-U processor is equipped with an infrared film drier while its functions are controlled by a microprocessor. Its throughput depends on the required cycle time (adjustable between 1.5 and 12 minutes) and film size. All normal film sizes, including roll film, can be processed. When set for an 8-minute cycle (100 seconds immersion time) for example, approximately 100 films of size 10 x 48 cm can be processed per hour.



### NDT-E (economy) film processor

In order to limit any detrimental effects on the environment, Agfa has developed the “Eco” (Ecology and economy) designated processors. Here, too, equipment and chemicals are carefully matched, thus complying with strict ecological requirements such as a maximum of 50 mg silver per square metre of processed film, for the disposal of rinse water.

This figure for silver content is at least fifteen times lower than for conventional developing systems. This is achieved through the considerably improved (cascade) fixing process, which additionally results in a bigger quantity of recovered silver.

Furthermore, measures have been taken to save on energy, chemical and water usage, thereby making the “eco” range of film processors as environmentally friendly as possible. Figure 1-10 shows the schematic lay-out of this high-tech processor.

The “S eco”-version has a 50 % higher production capacity than the U-version. A very useful option is its suitability for use in daylight, in combination with a matching film feeding system.

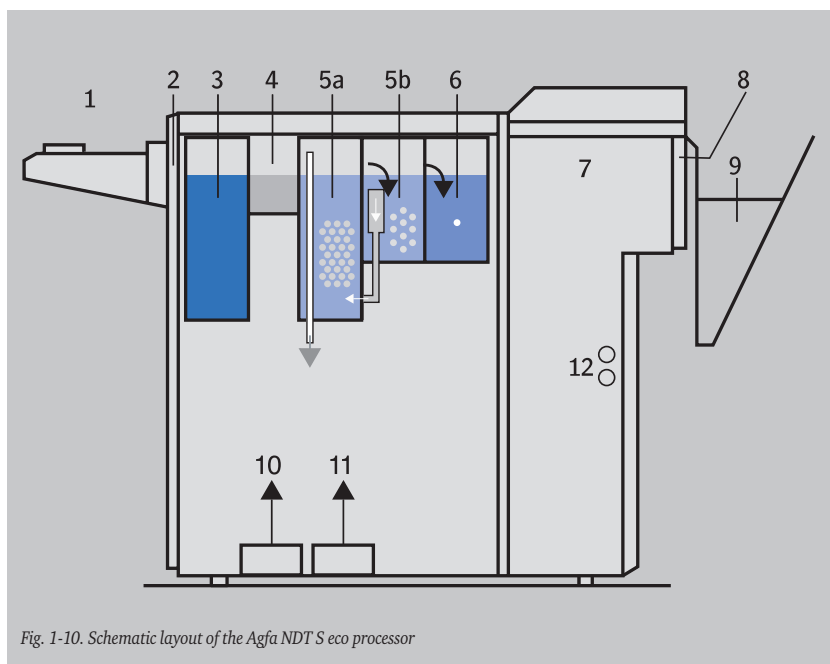

Fig. 1-10. Schematic layout of the Agfa NDT S eco processor

- |      |                      |    |                        |
|------|----------------------|----|------------------------|
| 1    | Film feeder          | 7  | Infrared dryer         |
| 2    | Film surface scanner | 8  | Film exit              |
| 3    | Developer tank       | 9  | Film receiving tray    |
| 4    | Rinse tank           | 10 | Fixer pump             |
| 5a/b | Fixer tanks          | 11 | Developer pump         |
| 6    | Final wash tank      | 12 | Overheating protection |

### 10.6 Checking the development process and film archiving properties

Besides exposure technique, many aspects influence the quality of the final radiograph. An important factor is the development system. Monitoring and quantifying the proper functioning of a development system is an essential part of quality control, as a properly exposed radiograph can be spoiled if the processes that follow are performed incorrectly. For the monitoring of the development process and archival properties of X-ray-films, Agfa has produced two methods: the so-called PMC-strips, and the Thio-Test. Both methods are based on the international standard ISO 11699 part 2, and the European standard EN 584 part 2, which describe a standard development process and the means to control its execution.

#### PMC-strips to check the developing process

To facilitate ongoing quality control, and ensure compliance with existing standards on systems classification, certified PMC-strips are used to monitor the development process. PMC is short for Processing Monitoring Control.

The purpose is to:

- demonstrate conformance with the standard film system as described in the standards ISO 11699 or EN 584
- demonstrate the consistency of the development system
- monitor and promote uniformity of the various development systems in different locations
- initiate timely corrective action if deviations occur

PMC-strips are film strips that have been “pre-exposed” in a regular step-pattern by the supplier, under special conditions and within narrow tolerances, but have not as yet been developed. They are supplied with a certificate of compliance with EN 584-2 and ISO 11699-2.

In the development system to be checked, a PMC-strip is processed routinely in a way identical to a normal radiograph. Finally, the various densities are measured with a densitometer.



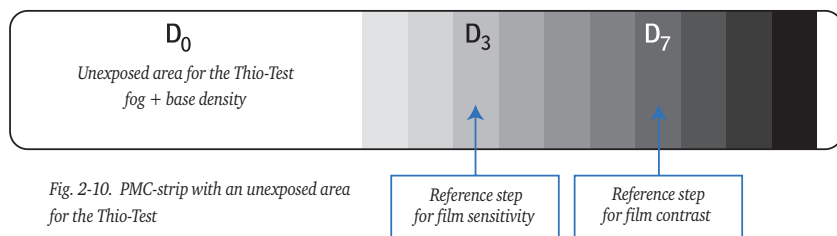

Fig. 2-10. PMC-strip with an unexposed area for the Thio-Test

A PMC-strip as shown in figure 2-10 has to be used whenever the chemicals in an automatic or manual processing system are replenished or changed. It is also advisable to use a PMC-strip regularly, but at least once a month, for a routine check of the development system.

A calibrated densitometer measures the following steps:

- $D_0$ : fog and base density ( $\leq 0.3$ )
- $D_3$ : density of step 3
- $D_7$ : density of step 7

The reference values according to the corresponding certificate are  $S_r$  and  $C_r$ .

The following calculations are then made:

- Sensitivity index  $S_x = D_3 - D_0$
- Contrast index  $C_x = (D_7 - D_3) \cdot S_r / S_x$

The system is acceptable if the following criteria are met:

- a.  $D_0 = \leq 0.3$
- b.  $S_x$  has a value  $\pm 10\%$  of  $S_r$
- c.  $C_x$  has a value between  $C_r + 15\%$  and  $C_r - 10\%$

If one or more of these criteria are not met, the development process must be adjusted.

### Thiosulphate-test to check film archiving properties

The archival properties of a radiographic image must also be determined in accordance with the standards ISO and EN by analysing the quantity of residual thiosulphate in the film's emulsion layers. This quantity depends on the thoroughness with which the fixing and rinsing processes have been carried out.

For storage over a period of 100 years, 100 g/m<sup>2</sup> is allowed; for a period of 10 years double this figure is allowed, see table 3-10. These values are difficult to measure however. The so-called Thio-Test, developed by Agfa, is a very useful and quick method to quantify film-keeping properties in practice.

The unexposed area on the PMC-strip shown in figure 2-10, apart from providing a reference for fog and base density, also allows for the Thio-Test to be carried out.

The components used for this test are:

- 1 The Thio-Test colour step-wedge
  - 2 A dropper-bottle of Thio-Test reagent
- The reagent consists of a 1% silver nitrate solution in demineralised water

The working method, which only takes a few minutes, is as follows:

- 1 apply the test liquid (reagent) to an unexposed part of undeveloped, dry film
- 2 allow to soak for 2 minutes,  $\pm 15$  seconds
- 3 remove excess liquid with absorbent paper
- 4 leave to dry for 1 minute before treating the reverse side
- 5 repeat the above procedure on the other side of the film, in exactly the same spot.

Evaluate as follows, within 30 minutes:

- 6 the test zone of the film is put against a white background
- 7 the Thio-Test colour strip is put on the film, as close to the spot as possible
- 8 the colour step of the wedge that resembles the colour of the test zone closest, is regarded definitive for life expectancy.

Colour wedge (from dark to light)	Thiosulphate (*g/m <sup>2</sup> )	Archival quality L.E. (Life expectancy)
Darkest	Min. 0.35	Film needs repeat treatment
Dark	Max. 0.20	L.E. 10 years
Light	Max. 0.10	L.E. 100 years
Lightest	max. 0.04	L.E. 500 years

Table 3-10. Colour steps for the Thio-Test. (\*)These values apply to films with double-sided emulsion layers.

A regular Thio-Test provides early detection of deficiencies in the development process, for example exhausted fixer solutions, irregular water supply or insufficient rinsing, and so prevents poorly processed films being archived.

## 10.7 Storage of exposed films

The way in which radiographs are handled and stored plays a very important role in their keeping properties. Films that must be kept for longer periods of time require the same ambient conditions as new unexposed films, i.e.:

- ambient temperatures below 24°C
- relative humidity of less than 60%
- preferably stacked on edge



## 11 Defect discernibility and image quality

Three factors govern the discernibility of defects in a radiograph:

1. **Geometrical effects:**
  - Size of the source
  - Source-to-object distance
  - Defect-to-film distance
2. **Film properties (governing image quality):**
  - Graininess
  - Contrast
  - Fog
  - Inherent unsharpness
3. **Quality of radiation applied.**

### 11.1 Unsharpness

#### Geometric unsharpness

X-ray tubes and radioactive sources always produce radiographs with a certain amount of blurring – the “geometric unsharpness”,  $U_g$  in fig. 1-11, because of the finite dimensions of the focal spot or source size.

The magnitude of this unsharpness,  $U_g$ , is given in the following equation:

$$U_g = \frac{s \cdot a}{F - a}$$

In which:

$s$  is the effective focus (or source) size

$F$  is the focus-to-film (or source-to-film) distance

$a$  is the defect-to-film distance

The maximum value of  $U_g$  related to a defect situated at a maximum distance from the film (and for which  $a = t$ ) can be calculated from the formula:

$$U_g(\max) = \frac{s \cdot t}{F - t}$$

In which:  $t =$  the thickness of the object

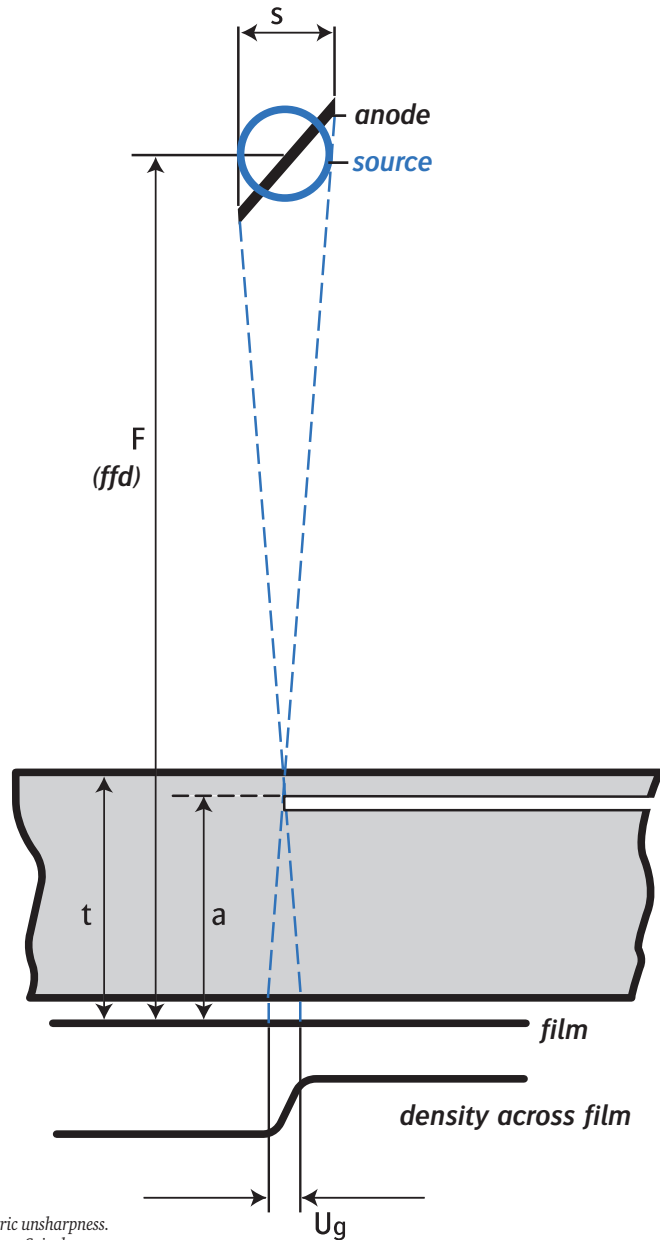

Fig. 1-11. Geometric unsharpness.  
The source diameter,  $S$ , is shown very large for clarity.





Consequently,  $U_g$  can be reduced to any required value by increasing the source-to-film distance. However, in view of the inverse square law this distance cannot be increased without limitation, as extremely long exposure-times would result. The formula also indicates that geometric unsharpness assumes more and more importance as the distance between defect and film increases.

A special case arises, however, when one uses a micro focus X-ray tube with a focal spot size in the range 10-50  $\mu\text{m}$ . With such a small focus size, the image can be deliberately magnified (see section 17.1) by using a short source-to-specimen distance, and a large specimen-to-film distance, and still retain an acceptably small value of  $U_g$ . The advantage of this technique, called the “projective magnification method”, is that the graininess always present in a photographic image is less of a disturbing factor in the discernibility of very small defects.

Figure 2-11 shows the effect of geometric unsharpness on the image of a defect smaller than the focus size.

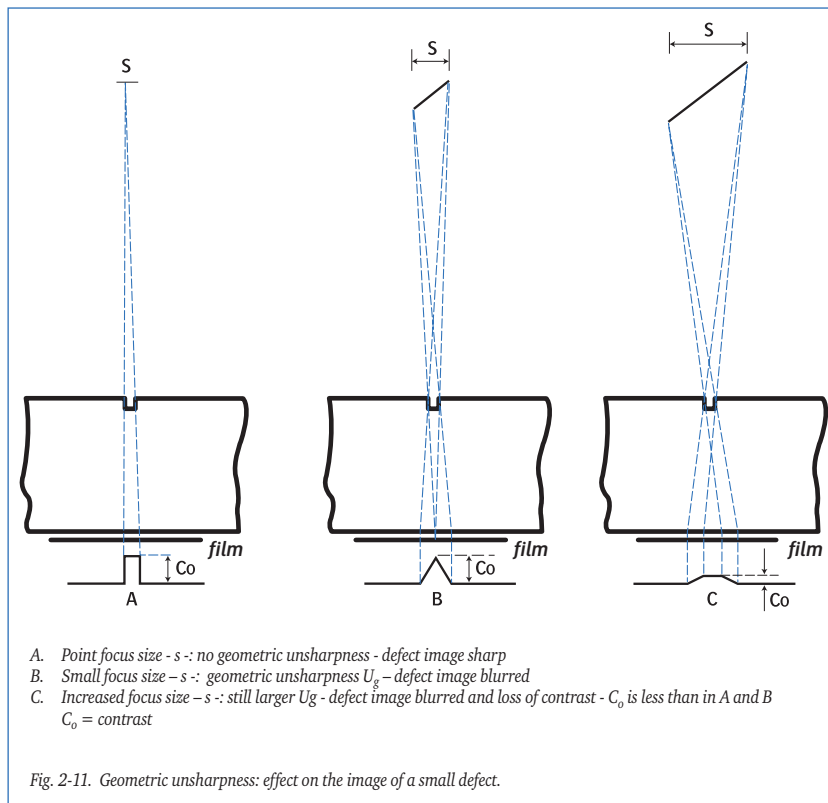

In this situation the unsharp images of each of the two edges of the defect may overlap, as shown in example C. The result is that image C not only becomes unsharp, but also suffers a reduction in contrast compared to image A, made with a point source and image B made with a relatively small source.

### Inherent unsharpness

Not only the silver halide crystals directly exposed to X-radiation are formed into grains of silver, but also (albeit to a lesser degree) the surrounding volume of emulsion. This cross-sectional area represents the “inherent unsharpness” or “film unsharpness”  $U_f$ .

So, even in the absence of geometric unsharpness, if the radiation energy is high enough, film unsharpness can occur: the so called “inherent unsharpness”. If a steel test plate with a sharp thickness transition is radiographed with high energy X-rays, there will be a gradual transition of film density across the image of the “step” from A to B.

Without inherent unsharpness, the film would show an absolutely sharp transition between the two densities, as shown in figure 3a-11. In practice, the density change across the image is as shown in figures 3b, 3c and 3d-11.

The width of this transitional area ( $U_f$ ), expressed in mm, is a measure of film unsharpness.

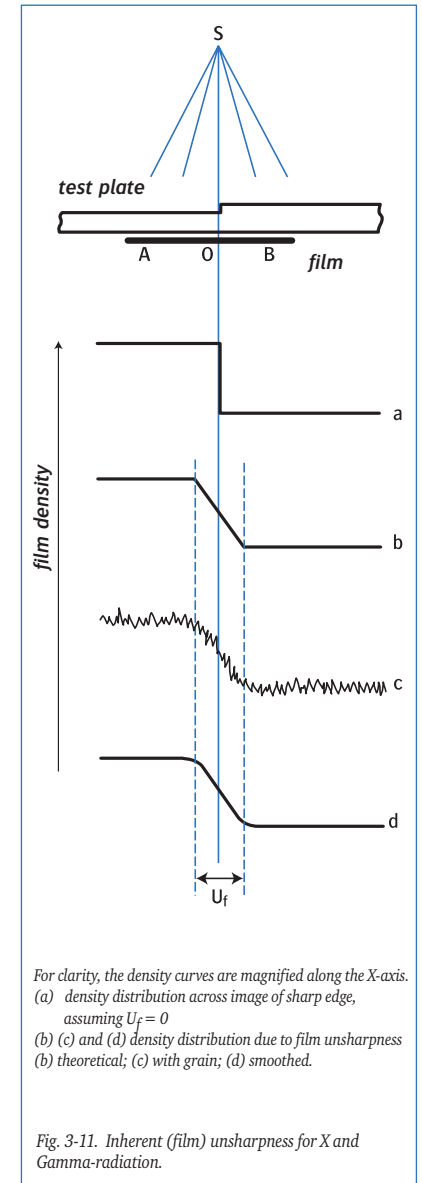

Table 1-11 and figure 4-11 show experimentally determined values of inherent unsharpness for film exposed at various radiation energy levels.

These values are based on the use of filters and thin lead intensifying screens; thicker screens produce slightly higher values. If no lead screens are used,  $U_f$  is 1.5 to 2 times smaller.  $U_f$  is influenced mainly by radiation intensity and the type of intensifying screens used; the type of film is hardly of any consequence.

The distance between film and intensifying screen is of great importance for the value of  $U_f$ . Good contact between film and intensifying screen is imperative and can be achieved by vacuum-packing of film and screens together.

Radiation energy	$U_f$ in mm
50 kV	0.05
100 kV	0.10
200 kV	0.15
400 kV	0.20
2 MeV	0.32
8 MeV	0.60
31 MeV	1.00
Se75 (320 keV)	0.18
Ir192 (450 keV)	0.25
Co60 (1.25 MeV)	0.35

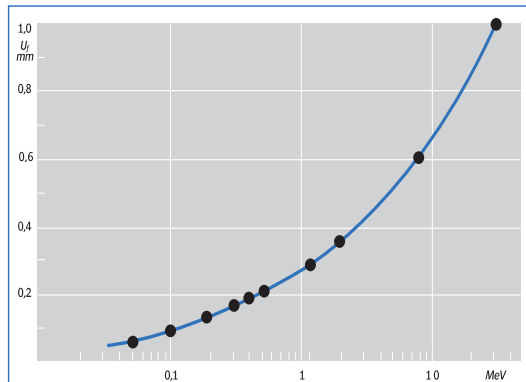

Fig. 4-11. Graphical representation of table 1-11. Values of  $U_f$  for X- and Gamma radiation at increasing radiation energies

Table 1-11. Empirical values of film unsharpness  $U_f$  at various radiation energies using lead intensifying screen

From the above information it can be deduced that  $U_f$  increases at higher radiation energies.

### Total unsharpness

Total film unsharpness  $U_t$  is determined by the combination of  $U_g$  and  $U_f$ . The two values cannot be just added up to arrive at a figure for  $U_t$ . In practice, the following formula produces the best approximation for film unsharpness  $U_t$ :

$$U_t = \sqrt{U_g^2 + U_f^2}$$

Broadly, if one value of unsharpness ( $U_g$  or  $U_f$ ) is more than twice the value of the other, the total unsharpness is equal to the largest single value; if both values of unsharpness are equal, total unsharpness is about  $\sqrt{2} = 1.4$  times the single value.

If necessary,  $U_g$  can be reduced by increasing the focus-to-film distance. This can only be done to a limited extent because, due to the inverse square law, exposure times would become extremely long. As a compromise an optimum focus-to-film distance  $F$  is chosen whereby  $U_g = U_f$ .

## 11.2 Selection of source-to-film distance

Preceding paragraphs of this chapter described the effects of geometric unsharpness and the possibility to influence this by adjusting the source-to-film distance.

This section will expand on this.

To obtain a radiograph which is as sharp as possible, so as to show maximum detail, the total unsharpness should be kept to a minimum. The radiation energy level selected for making the radiograph, see chapter 9, can serve as a lead. It is, after all, determined by the thickness of the material to be radiographed, but is at the same time also responsible for film unsharpness  $U_f$ , which can be extracted from table 1-11 and or figure 4-11.

It is no use to try and keep geometric unsharpness  $U_g$  far below the value of  $U_f$ , as in that case  $U_f$  determines the total unsharpness anyhow.

If the aim is to make geometric unsharpness  $U_g$  equal to the value of  $U_f$ , the source-to-film distance ( $F$ ) required can be calculated from the following formula :

$$F = \frac{t(U_t + 1.4s)}{U_t}$$

In which:

- $F$  = source-to-film-distance
- $U_t$  = total unsharpness
- $t$  = thickness of the object
- $s$  = effective source size

All measurements in mm.

Instead of calculating  $F$ , various code-based procedures and guidelines provide graphs from which minimum distance ( $F_{\min}$ ) can be determined. Figure 5-11 shows a nomogram on the basis of EN 1435, from which the minimum focus distance for two quality levels (category A and B) can be extracted.

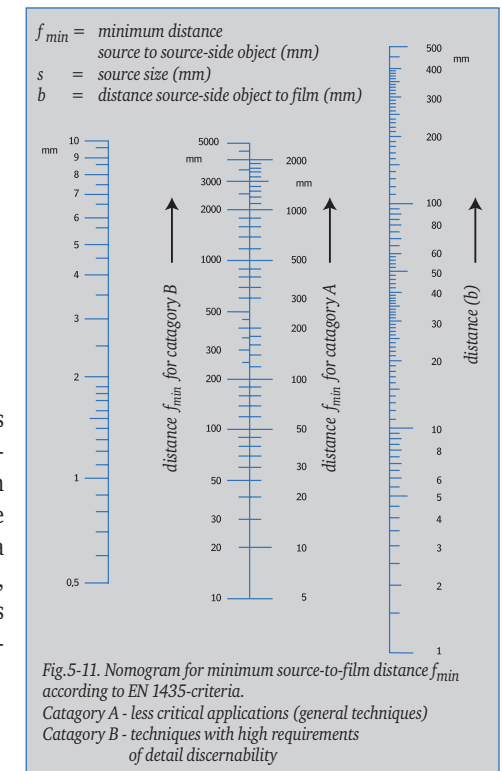

Fig. 5-11. Nomogram for minimum source-to-film distance  $f_{\min}$  according to EN 1435-criteria. Category A - less critical applications (general techniques) Category B - techniques with high requirements of detail discernability

The above graph appears enlarged in the appendix.



### 11.3 Other considerations with regard to the source-to-film distance

#### Inverse square law

As explained in the previous section, the effect of  $U_g$  can be reduced by increasing the focus-to-film distance  $F$ .

One of the properties of electromagnetic radiation is that its intensity is inversely proportional to the square of the distance, better known as the “inverse square law”. Both X- and Gamma radiation follows that law.

The intensity of radiation per unit area of film is inversely proportional to the square of the source-to-film distance (s-f-d).

As figure 6-11 shows, at a distance  $2F$  from the source, a beam of rays will cover an area (b) four times greater than area (a) at distance  $F$ .

Consequently, the intensity per unit of surface area for (b) will be only  $1/4$  of the value for area (a). This means that, all other parameters being equal, at distance  $2F$  exposure time must be multiplied by four to obtain the same film density.

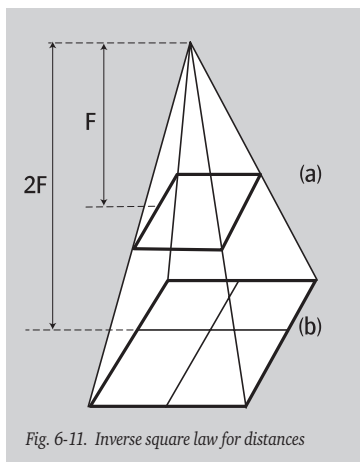

Fig. 6-11. Inverse square law for distances

This principle obviously has its (economical and practical) limitations, beyond which a further increase in s-f-d is just not feasible.

#### Selection of radiation energy (kV)

Once the appropriate source-to-film distance is chosen, the correct kilo voltage can be determined from an exposure chart (see chapter 9).

The importance of choosing the exact kilo voltage varies considerably with the kilo voltage range being considered. For X-rays below 150 kV the choice is reasonably critical and gets more critical still at lower kilo voltages.

The kilo voltage to be applied is specified in (EN) standards, see chapter 20.

Table 2-11 gives useful empirical rule-of-thumb values for radiographs of aluminium, steel or plastic objects.

Material	kV-value
Steel	100 kV + 8 kV/mm
Aluminium	50 kV + 2 kV/mm
Plastics	20 kV + 0.2 kV/mm

Table 2-11. Rule-of-thumb values for the selection of kilo voltage

Examples :

15 mm steel:	$100 + 15 \times 8 = 220$ kV
12 mm aluminium:	$50 + 12 \times 2 = 74$ kV
10 mm plastics:	$20 + 10 \times 0.2 = 22$ kV

In the range 200-400 kV, only a significant change in voltage, say 30-40 kV, will cause a noticeable difference in defect discernibility.

#### Selection of gamma source

As it is not possible to vary the radiation energy emitted by a gamma-ray source, it is necessary to indicate a range of thickness which may be satisfactorily examined with each type of radio-isotope.

The upper limit is decided by the source strengths commercially available and the maximum tolerable exposure time: the lower limit is determined by the decrease in contrast and the related reduced image quality.

The lower limit, therefore, depends on the required degree of defect discernibility.

When this is insufficient in comparison to what is achievable by the use of X-ray equipment, another type of isotope providing a reduced energy radiation could be selected.

Table 3-11 shows the thickness range usually recommended for various gamma sources. The table applies to steel. If, for reasons of convenience, gamma rays are used on thin specimens which could also be X-rayed, it should be understood that the resulting radiographs will be of poorer quality compared to X-radiographs.

Source type	Standard sensitivity technique in mm	High sensitivity technique in mm
Co60	30 - 200	60 - 150
Ir192	10 - 80	20 - 70
Se70	5 - 40	10 - 30
Yb169	1 - 15	3 - 10
Tm170	1 - 10	4 - 8

Table 3-11. Thickness ranges in mm for examining steel with the usual types of gamma sources.

Note: Standard sensitivity permits a slightly poorer image quality than high sensitivity. Thus a larger thickness range can be inspected coping with the quality requirements.



## 11.4 Radiation hardness and film contrast

When radiation hardness increases, the half-value thickness (HVT) also increases. Tables 2-2 and 3-2 for steel and lead respectively show this in figures.

This is why in an object with different thicknesses, image contrast diminishes when radiation hardness increases. Figure 7-11 clearly illustrates this.

The left side of a step-wedge is radiographed with 150 kV, the right side with 80 kV. The right side shows the greater contrast between two steps, whereas on the left the contrast range is the biggest.

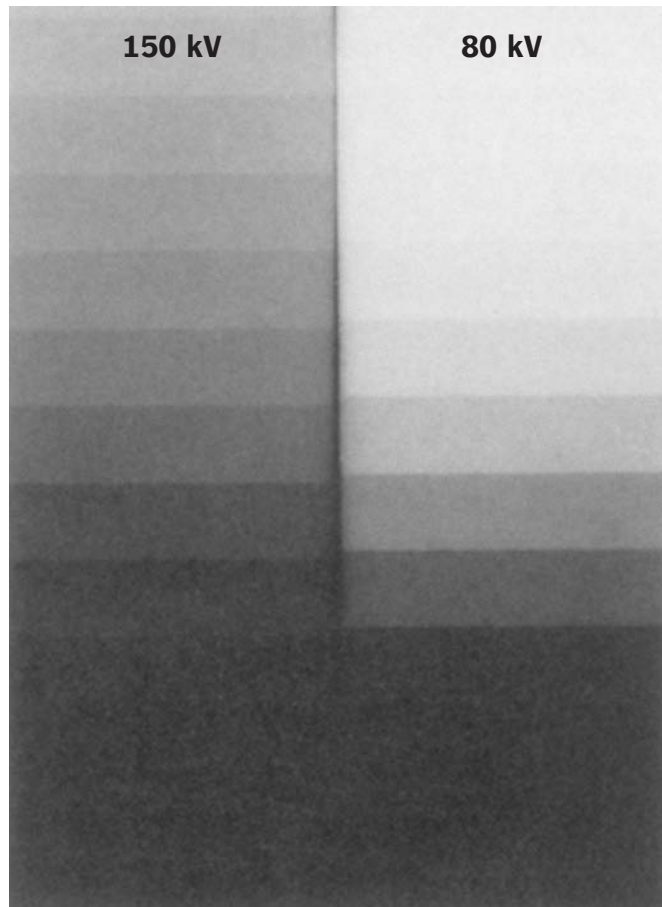

Fig. 7-11. X-rays of a step-wedge with 150 kV (left) and 80 kV (right).

## 11.5 Summary of factors that influence image quality

The factors that influence image quality are:

1. Contrast
2. Unsharpness
3. Graininess

### 1 Contrast depends on:

- Radiation energy (hardness)
- Variation in thickness
- Backscatter
- Front- and back screen
- Film-screen combination
- Film-screen contact
- Defect location, depth as well as orientation

### 2 Unsharpness depends on:

- Size of focus
- Thickness of the object
- Source-to-film distance
- Radiation energy (hardness)
- Film-screen combination
- Film-screen contact

### 3 Graininess depends on:

- Type of film
- Type of screen
- Developing procedure
- Radiation energy (hardness)

## 12 Defect orientation, image distortion and useful film length

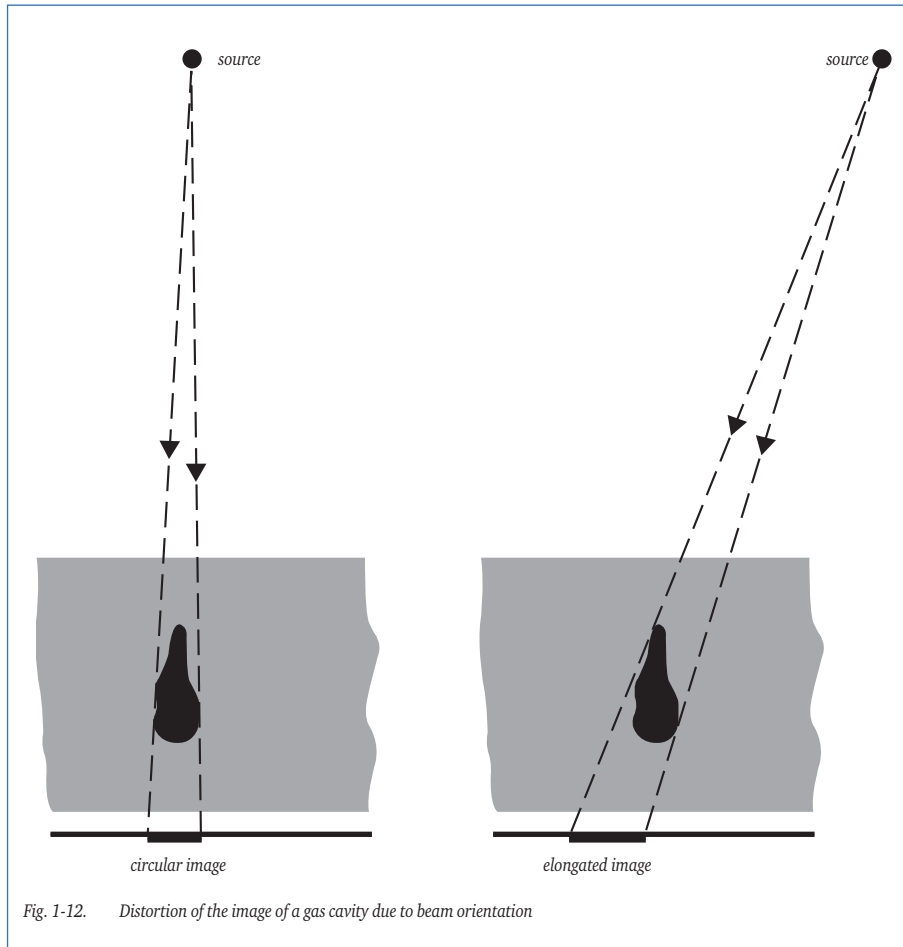

### 12.1 Defect detectability and image distortion

On a radiograph, a three-dimensional object is presented in a two-dimensional plane (the film). The appearance of both the object and its defects depends on the orientation of radiation relative to the object. As shown in figure 1-12, the image of a gas cavity in a casting may be circular or elongated depending on beam orientation.

In general, the beam of radiation should be at right angles to the film and a specimen should whenever possible be laid flat on the film cassette. Special angle shots are, however, sometimes useful to detect defects which are unfavourable oriented with regard to the X-ray direction. This influence of X-ray beam angles relative to the orientation of a defect is also described and illustrated in section 17.4.

Figure 2-12 (A) shows a situation whereby detection of lack-of-side wall fusion in a V-weld is not performed optimally. Angled radiation (B) is more likely to show up this type of weld defect.

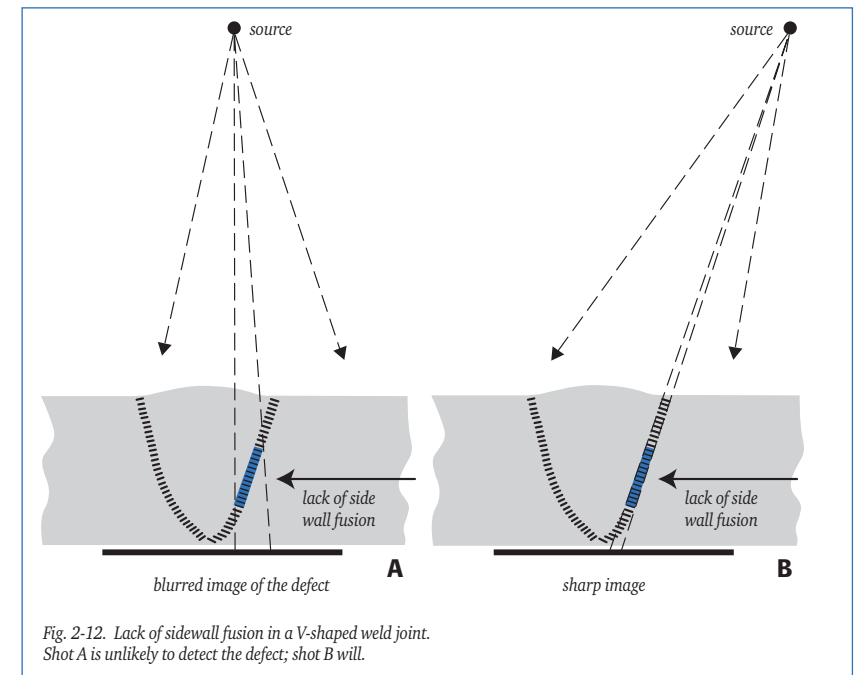

## 12.2 Useful film length

When radiographing curved objects, for example a circumferential weld in a pipe, as figure 3-12 shows, the resulting image will be distorted. Variations in density will also occur. As a result of the curvature of the pipe with a wall thickness  $t$ , the material thickness to be penetrated increases to  $T$ , so film density is lower at the ends of the film than in the middle.

Moreover, if defects are projected nearer the ends of a film, distortion of the defect image will become greater. The film length suitable for defect interpretation is therefore limited. This so-called "useful film length" is, depending on the nature of the work, defined in codes e.g. in EN 1435.

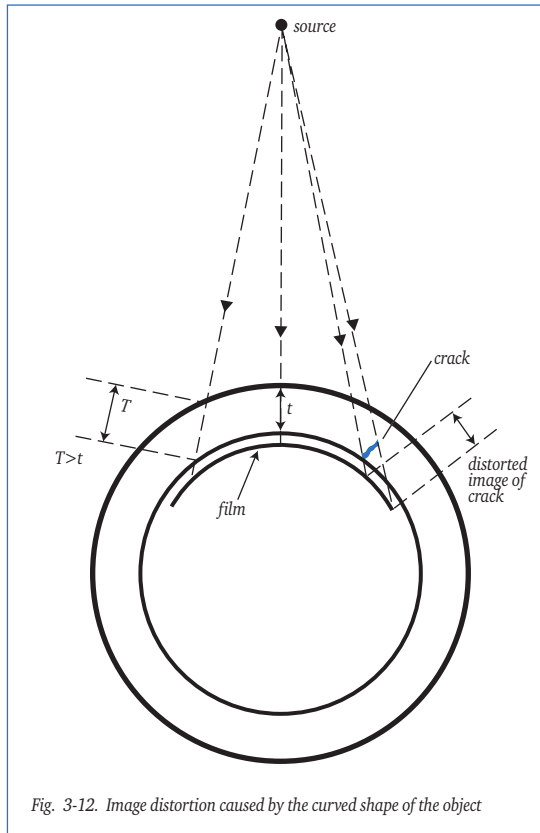

Fig. 3-12. Image distortion caused by the curved shape of the object

It is not always practicable to apply the single-wall technique as shown in figure 3-12.

In order to still achieve 100 % examination, the double-wall / single-image technique (DW-SI) is applied. (In NDT jargon the abbreviations DW-SI and DW-DI are frequently used for Double Wall-Single Image and Double Wall-Double Image respectively.)

In that case several radiographs are made, spaced equally around the circumference of the item under examination. The number of radiographs to be made depends on the standard or code to be complied with.

In codes, useful film length is determined by the percentage of extra wall thickness which may be penetrated in relation to the nominal wall thickness ( $t$ ) of the pipe. Percentages of 10, 20 and 30 are commonly applied. For general use, 20 % is a practical value whereby the lightest section of the film shall have a density of at least 2.

The number of radiographs necessary for 100 % examination of a circumferential weld can, through calculation, also be obtained from the codes. When large numbers of similar welds are involved, this is an important figure, because too many radiographs would be uneconomical and too few would lead to insufficient quality of the examination. The minimum number of radiographs required for various pipe diameters and wall thicknesses at varying source positions can be derived from the graph in figure 4-12. The graph is applicable to single wall and double wall technique, whereby the maximum increase in thickness to be penetrated is 20 %, in accordance with EN 1435 A.

### Example 1:

An X-ray tube with an outside diameter of 300 mm is used to examine a circumferential weld in a pipe of a diameter  $D_e$  of 200 mm and a wall thickness  $t$  of 10 mm. The distance between the focal spot and the outside of the X-ray tube is  $300/2 = 150$  mm.  $F = \text{half the X-ray tube diameter} + D_e = 150 + 200 = 350$  mm.

$$t/D_e = 10/200 = 0.05 \text{ and } D_e/F = 200/350 = 0.57$$

The intersection of the two co-ordinates (0.05 and 0.57) is in the range where  $n = 5$ , so the number of radiographs must be at least 5.

### Example 2:

When using a source placed against the pipe wall,  $t/D_e = 10/200 = 0.05$  and  $D_e/F = 200/(200+10) = 200/210 = 0.95$ .

The intersection of the two co-ordinates now lies in the area where  $n = 4$ .

So, by using a radioactive source which is located closer to the pipe surface, one less exposure would still ensure compliance with EN 1435A.

Initially, the code would however have to allow the use of an isotope instead of an X-ray tube.

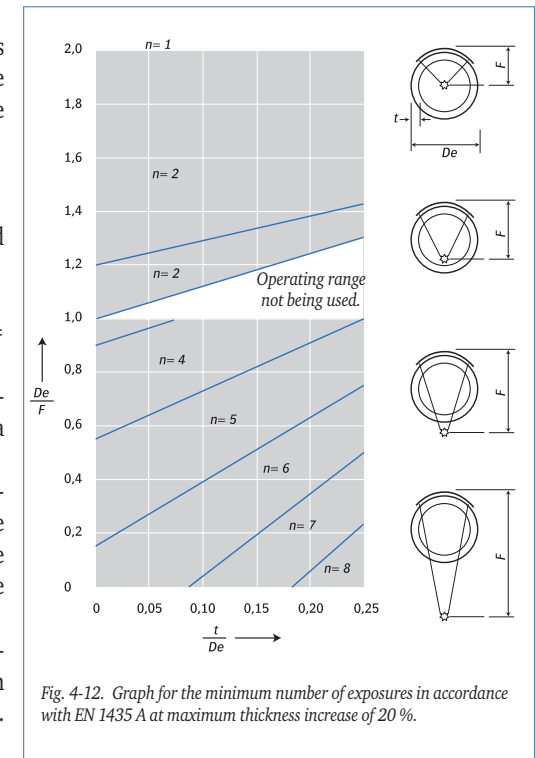
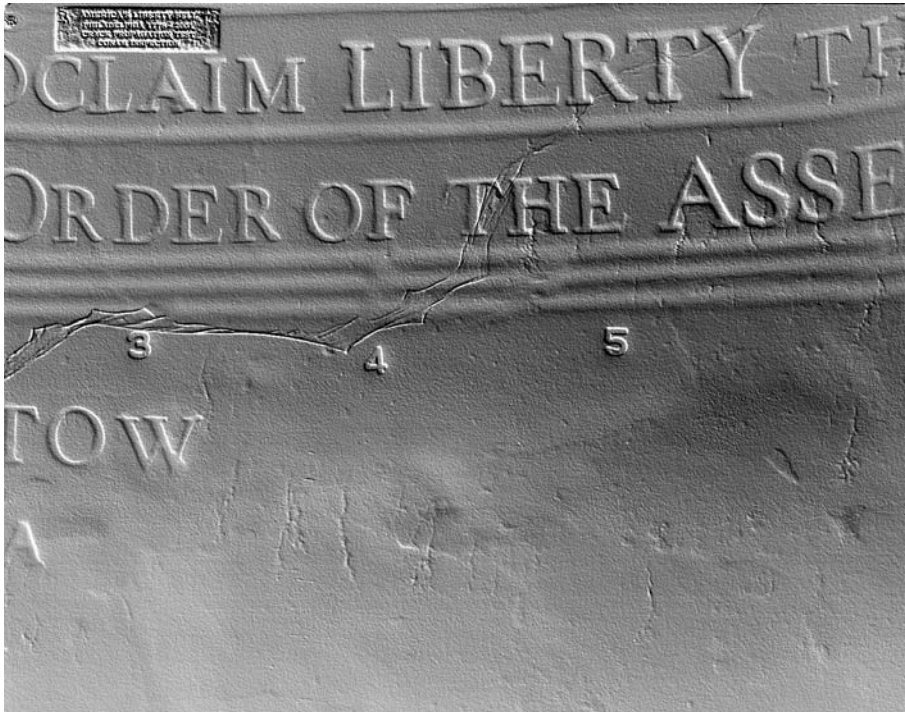

Fig. 4-12. Graph for the minimum number of exposures in accordance with EN 1435 A at maximum thickness increase of 20 %.

This graph appears enlarged in the appendix.



## 13 Image quality



Digitised and enhanced image of a radiograph of the (American) Liberty Bell.  
The image was used to monitor possible lengthening of the crack.

### 13.1 Factors influencing image quality

With regard to image quality, the term frequently used is “sensitivity”. Sensitivity determines the extent to which a radiograph is able to clearly show (anomaly) details of a certain size. Sensitivity in this sense must not be confused with the sensitivity or “speed” of the film. (see section 7.5).

**Discernibility of defects on a radiograph depends in general on:**

- the quality of the radiation
- the properties of the film
- the film viewing conditions

Image quality is governed by contrast, sharpness and film graininess.

**Image contrast is affected by :**

- differences in thickness of the specimen
- the radio-opacity (radiation transparency) of the specimen and its defects
- the shape and (depth)location of the defects
- the quality (hardness) of the radiation
- the amount and effects of scattered radiation
- the effect of filters used

**Film contrast depends on:**

- the type of film
- the density level

**Sharpness of an image is governed by:**

- the (effective) size of the focal spot or radiation source
- the source-to-object distance
- the object-to-film distance
- the contact between film and intensifying screens
- the type of intensifying screens used
- the radiation energy used

The last factor, graininess, depends on :

- the thickness of the emulsion layer
- the concentration of silver crystals in the emulsion (silver/gelatine ratio)
- the size of the silver crystals
- the radiation energy used
- the developing process employed

The radiation energy level is the only factor that can be influenced by the radiographer; the other factors are determined by the film making process.

### 13.2 Image quality indicators (IQI's)

In the past it was thought possible to assess the smallest defect detectable, by fixing a simple type of indicator on the test object during exposure.

This would supposedly guarantee that defects of a certain minimum size, expressed as a percentage of the material thickness, could be detected. In practice, however, this proved not to be achievable.

In particular where small cracks and other two-dimensional defects are concerned, it can never be guaranteed that they are not in fact present when no indication of them can be found in the X-ray image.

However, it is reasonable to expect that at least the quality of the radiographs, and of course the rest of the entire process the film undergoes, meets certain requirements.

The probability is high that defects will be more easily detected when the image quality is high. The exposure technique and required image quality, described in the code, depend on the purpose for which the object involved will be used.

In order to be able to assess and quantify the image quality of a radiograph, it needs to be converted into a numerical value, and to do this “image quality indicators” (IQI) are used, known in the USA as “penetrameters”.

Image quality indicators typically consist of a series of wires of increasing diameters, or a series of small plates of different thicknesses, with holes drilled in them of increasing diameters.

Although codes describe their techniques differently, they agree on the following points:

- An image quality indicator shall be placed at the source-side of the object being examined,
- If it is not possible to place the indicator on the source-side, it may be located on the film-side. This exceptional situation must be indicated by a lead letter “F” on or directly adjacent to the indicator,
- The material of the indicator must be identical to the material being examined.

The image quality of a radiograph is, for example, defined as the number of the thinnest wire still visible, and is generally said to have “image quality number -X-”.

The image quality can also be expressed as a percentage of the object thickness examined. If, for instance, the diameter of the thinnest wire visible to the naked eye is 0.2 mm and material thickness at the point of exposure is 10 mm, wire discernibility or wire recognizability is quoted as 2 %.

As emphasised above, the use of an IQI does not guarantee detection of defects of comparable size.

It would be incorrect to say that because a wire of 2 % of the object thickness can be seen on the radiograph, a crack of similar size can also be detected.

The orientation, relative to the X-ray beam, of a defect plays an important role in its discernibility (see section 12.1.)

There are various types of IQI, but the four most commonly used are:

1. the wire type (used in most European countries)
2. the step-hole type (still occasionally used in France, but the wire type is generally accepted as well.)
3. small plates with drilled holes, called penetrameters, which are used for ASME-work, although the ASME-code nowadays includes the wire-type IQI.
4. the duplex IQI.

In some countries (e.g. Japan and France) additional means (such as step-wedges) are used, to verify contrast and check the kV-value used.

At the location of the (step)-wedge, there must be a minimum specified difference in density compared to the density at a location on the film where penetrated material thickness equals nominal wall thickness.

#### Wire-type IQI according to EN 462-1

EN 462-1 standardises four wire-type IQI's. Each one is made up of seven equidistant parallel wires of various diameters, as shown in figure 1-13.

In the USA IQ's are known as penetrameters.

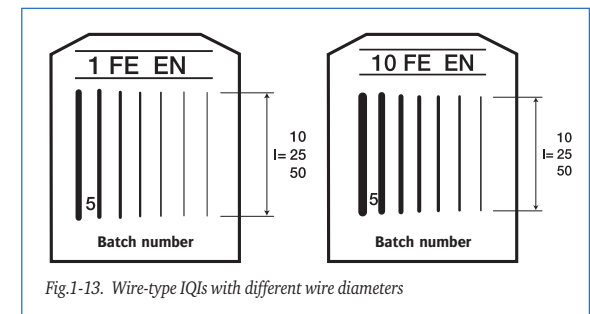

Fig.1-13. Wire-type IQIs with different wire diameters



Table 1-13 shows the wire combinations for the four IQI's according to EN 462-01. The diameters of the wires are given in table 2-13.

IQI	Wire numbers	Wire diameter from/to (mm)
1 EN	1 to 7 inclusive	3.2 to 0.80 inclusive
6 EN	6 to 12 inclusive	1 to 0.25 inclusive
10 EN	10 to 16 inclusive	0.40 to 0.10 inclusive
13 EN	13 to 19 inclusive	0.2 to 0.05 inclusive

Table 1-13. Wire IQIs according to EN 462-01.

EN-type IQI's are manufactured with wires of steel, aluminium, titanium or copper, depending on the type of material to be examined. On each IQI the wire material is indicated. Fe for steel, Al for aluminium, Ti for titanium and Cu for copper.

Diameter (mm)	3.20	2.50	2.00	1.60	1.25	1.00	0.80	0.63	0.50	0.40
Wire nr.	1	2	3	4	5	6	7	8	9	10
Diameter (mm)	0.32	0.25	0.20	0.16	0.125	0.10	0.08	0.063	0.05	
Wire no.	11	12	13	14	15	16	17	18	19	

### 13.3 List of common IQI's

Figure 2-13 shows the five most common IQI's. Their origin and description can be found in the following standards:

- EN 462-01 Europe
- BS 3971 Great Britain
- ASTM 747 USA
- ASTM 1025 USA
- AFNOR NF A 04-304 France

ASTM 747 describes the wire penetrameter quite similar to wire penetrameters of other origin. ASTM 1025 describes the plaque penetrameter similar to AFNOR. Both types of ASTM IQI's have been developed and standardised in the USA, they now are used world-wide.

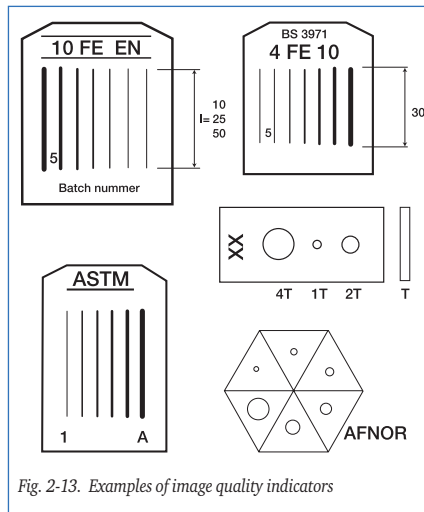

Fig. 2-13. Examples of image quality indicators

### ASTM 1025 IQI's

The plaques have markings showing their thickness in thousandths of an inch. Each plaque has three holes of diameters 1T, 2T and 4T. T being the thickness of the plaque.

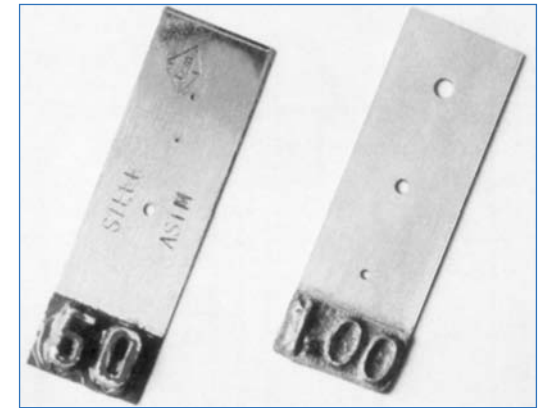

Fig. 3-13. ASTM plaque type IQI

Thin plaques with  $T < 0.01$ " form an exception to this rule. Hole diameters for these plaques are always  $0.01$ ",  $0.02$ " and  $0.04$ ", so do not comply with the 1T, 2T, 4T rule.

These types of plaque are identifiable through notches cut in the edge, by which they can also be identified on the radiograph.

Originally it was standard practice to use a plate of 2 % of the specimen thickness, but at present 1 % and 4 % plates are used too.

If T is 2 % of the specimen thickness and the 2T hole can be seen on the radiograph, the attained sensitivity level is said to be (2-2T), etc. Equivalent sensitivity values in percentages are shown in table 3-13.

At least three sides of a penetrameter must be visible on the radiograph. The thickness of the penetrameter in relation to the specimen thickness defines the "contrast sensitivity". The size of the smallest hole visible defines the "detail sensitivity".

Level	Equivalent (%)	Level	Equivalent (%)
1 - 1T	0.7	2 - 2T	2.0
1 - 2T	1.0	2 - 4T	2.8
2 - 1T	1.4	4 - 2T	4.0

Table 3-13. ASTM Equivalent image quality indicator

### MIL-STD IQI's (military standards)

In the past for some applications specific MIL-standard (MIL-STD) IQI's should be used only. They are very similar to ASTM IQI's. Nowadays the MIL-STD accepts that they are replaced by the almost identical ASTM type IQI's providing they meet the requirements specified in the MIL-STD. Nevertheless MIL-STD IQI's are still available and in use.



### AFNOR IQI's

The AFNOR-type IQI's originate in France. They consist of metal step wedges of the same material as the object to be examined. The thickness of the steps increases in arithmetical progression. Each step has one or more holes with a diameter equal to the thickness of that step. There are various models of step wedges. The most common types are rectangular with square steps measuring 15x15 mm and hexagonal with triangular steps measuring 14mm. See figure 4-13.

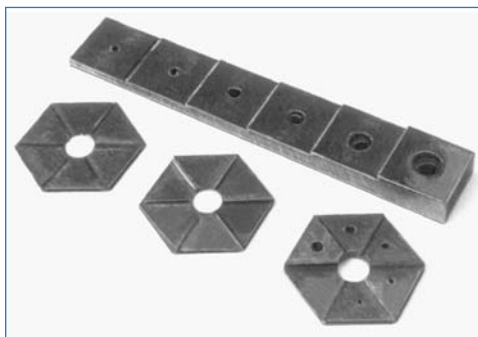

Fig. 4-13. French AFNOR IQIs

Steps thinner than 0.8 mm, have two holes of the same diameter. For a step to be regarded as visible, all the holes in that particular step must be clearly seen on the film.

The French standard AFNOR NF A04.304 includes an addendum, which defines the "index of visibility".

For each radiograph a record is made of:

1. the number of visible holes (a)
2. the number of holes (b) of a diameter equal to or greater than 5 % of the material thickness being radiographed.

The index of visibility N is given by the formula:  $N = a - b$ .

The value of N may be positive, zero or negative.

Image quality improves as the value of N increases.

### Duplex IQIs



Fig. 5-13. Duplex wire IQI

Duplex IQI's are described in norm EN 462-5. The duplex IQI consists of a number of pairs ("duplex") of wires or thin strips made of platinum or tungsten, of increasingly smaller size and diminishing distances for each pair.

Figure 5-13 shows such an IQI made up of pairs of wires.

The duplex IQI has been in existence for decades but is no longer current in conventional film radiography because of their high cost and limited possibilities of application. It is, however, increasingly used in digital radiography, because it is perfectly suited to determine contrast and (un)sharpness.

### 13.4 Position of the IQI

To be of any value in checking the factors defining sharpness and quality, the IQI must be placed on the source side of the specimen. If the source side is not accessible, the IQI is placed on the film side. In the latter position visibility is no longer an indication of geometric unsharpness, but still a check on the developing process and radiation energy used.

### 13.5 IQI sensitivity values

It is important to realise that any IQI acceptance-value must be based on a particular type of IQI **and** the thickness of the object being examined. When IQI sensitivity is expressed in a percentage of object thickness, a lower recorded value indicates a higher radiographic sensitivity, hence better image quality.



Before a particular difference in density in a radiograph is attributed to a defect in the object examined, it must be sure that it is not the result of incorrect handling- or processing of the film. It is, therefore, essential to be able to recognise such faults when examining the film in order to prevent their recurrence. It is often possible to identify faults due to wrong processing by looking obliquely at the surface of the film while facing towards the light, and comparing the two emulsion surfaces. The X-ray image usually is identical on both sides of the film, while a fault in processing will frequently affect only one surface, and can be seen as a change in reflection on the surface.

The most common faults, and their possible causes, are listed below:

### **Insufficient contrast**

#### **a: with normal density:**

1. radiation too hard
2. over-exposure compensated by reduced developing time
3. unsuitable or wrongly mixed developer
4. prolonged development in too cold a developing bath

#### **b: with insufficient density:**

1. insufficient development
2. exhausted developer
3. unsuitable or wrongly mixed developer

### **Excessive contrast (i.e. lack of intermediate tones)**

1. radiation too soft
2. under-exposure, compensated by prolonged developing
3. unsuitable or wrongly mixed developer

### **General lack of density**

1. radiation too soft
2. under-exposure, compensated by prolonged developing
3. unsuitable or wrongly mixed developer

### **General excessive density**

1. over-exposure
2. prolonged development or developing temperature too high
3. unsuitable or wrongly mixed developer

### **Insufficient sharpness**

1. source-to-focus distance too short
2. source or object moved during exposure
3. film-to-object distance too great
4. dimensions of source or focus too big
5. poor contact between film and screens
6. wrong type of foil used





### Grey fog (local or overall)

1. unsuitable dark room safelighting
2. excessive exposure to safelight (i.e. too long or too close)
3. film accidentally exposed to X-ray or Gamma-ray or to white light
4. heavy scatter
5. film out-of-date or stored under unsuitable conditions (ground fog)
6. extreme under-exposure compensated by excessive developing
7. exhausted or wrongly mixed developer
8. film cassette with film exposed to heat (e.g. sunlight, heat from radiators etc.)
9. cassette not properly closed (edge fog)

### Yellow fog

1. prolonged development in badly oxidised developer
2. exhausted fixing bath
3. insufficient rinsing between developing and fixing

*Note: It may take months before yellow fog becomes apparent.*

### Dichroic fog

(i.e. greenish-yellow by reflected light, pink by transmitted light)

1. developer contaminated with fixer
2. film insufficiently rinsed after development and subsequently fixed in exhausted fixer
3. film stuck to another film when placed in fixer (in which case the development continues in the fixing bath)
4. prolonged development in exhausted developer
5. film partly fixed in an exhausted fixing bath, exposed to white light and then fixed again

### Mottled fog

A greyish, mottled fog generally means the film is out-of-date or that it has been stored under unfavourable conditions, e.g. in damp surroundings.

### Whitish deposit

1. water used to make up developer or fixer too hard
2. wash water too hard
3. film insufficiently rinsed after development

### Clear patches

1. minute round spots with sharp edges: the film was not kept moving in the first 30 seconds of development
2. drops of fixer or water fell onto the film before development
3. marks from mechanical damage to the emulsion before exposure
4. marks due to rapid and uneven drying of the film (this occurs when there are still droplets of water on the film when placed in the drying cabinet)
5. clear patches can occur from the film sticking to another film or to the tank wall during development
6. grease on the film slowing down or preventing the penetration of the developer

7. screen(s) in poor condition
8. foreign bodies (for example metal particles ) between film and screen during exposure
9. small, clear, hollow spots (usually with dark edges) may occur when the emulsion has been subjected to local attack of bacteria. This is generally the result of slow drying in a warm damp climate, particularly if there are impurities in the wash water.

### Clear lines or streaks

1. the film envelope has been scored with a pointed object before exposure.
2. film insufficiently moved during development
3. uneven drying (film has been carelessly wiped dry after washing)
4. drops of fixer or stopbath have fallen on the emulsion before development

### Clear shapes

1. clear crescent shapes may appear when, before exposure, the film has been bent between two fingers
2. fingerprints may occur when the film has been touched with dirty fingers, contaminated for example with grease, fixer, stopbath or acid

### Dark patches

1. drops of developer have fallen onto the film before development
2. drops of water have fallen onto the film before development
3. electrical discharge marks, especially at low relative humidity of the air
4. marks from mechanical damage to the emulsion after exposure

### Dark lines or streaks

1. the emulsion has been scratched after exposure
2. the film envelope containing the film has been scored or written on with a pointed object after exposure
3. insufficient agitation of the film during development
4. uneven drying
5. water or developer has trickled down the surface of the emulsion prior to development

### Dark shapes

1. dark crescent shapes (see “clear shapes” above); these are darker than the surrounding area if the bending occurred after exposure
2. fingerprints: the film has been touched with dirty fingers
3. electrical discharge (see “dark patches”).







Neutron radiograph of an iris flower made on Agfa D3 s.c. (single coated)  
Organic substances are well suited to examination by this type of radiation.

## 15 Film interpretation and reference radiographs

### 15.1 Film interpretation

The common term for film interpretation is film viewing. Film viewing in fact means the evaluation of the image quality of a radiograph for compliance with the code requirements and the interpretation of details of any possible defect visible on the film.

For this purpose, the film is placed in front of an illuminated screen of appropriate brightness/luminance. The edges of the film and areas of low density need to be masked to avoid glare. The following conditions are important for good film interpretation:

- brightness of the illuminated screen (luminance)
- density of the radiograph
- diffusion and evenness of the illuminated screen
- ambient light in the viewing room
- film viewer's eye-sight

Poor viewing conditions may cause important defect information on a radiograph to go unseen.

EN 25880 provides detailed recommendations for good film viewing conditions. The luminance of the light passing through a radiograph shall not be less than 30 cd/m<sup>2</sup> and, whenever possible, not less than 100 cd/m<sup>2</sup> (cd = candela). These minimum values require a viewing box luminance of 3000 cd/m<sup>2</sup> for a film density of 2.0.

The practical difficulties of providing the required luminance for a film density of 4.0 are considerable. The main problem with constructing a film-viewing box for these higher densities is the dissipation of heat from the lamps. However, by limiting the film area requiring such high power lighting, it becomes possible to view radiographs of a film density of 4.

The light of the viewing box must be diffuse and preferably white. Radiographs should be viewed in a darkened room, although total darkness is not necessary.

Care must be taken that as little light as possible is reflected off the film surface towards the film viewer. If the film viewer enters a viewing room from full daylight, some time must be allowed for the eyes to adapt to the dark.

A yearly eye-test according to EN473 for general visual acuity is required while especially sight at close range needs to be checked. The film viewer must be able to read a Jaeger number 1 letter at 300 mm distance with one eye, with or without corrective aids.

The trained eye is capable of discerning an abrupt density change/step of 1 %.

While interpreting, a magnifying glass of power 3 to 4 can be advantageous.



## 15.2 The film-interpreter

Apart from the requirements regarding “viewing conditions” and “viewing equipment” the film-interpreter (film viewer) shall have thorough knowledge of the manufacturing process of the object being examined and of any defects it may contain. The type of defects that may occur in castings, obviously, differs from those in welded constructions. Different welding processes have their own characteristic defects which the film interpreter must know to be able to interpret the radiograph.

To become a qualified NDT operator, various training courses, course materials and leaflets specifying the requirements they need to comply with, exist. The European NDT-industry conforms to the qualification standards of the American ASNT organisation. So far, a training programme for film-interpreter has not been established in similar fashion. Textbooks for example are not uniform. Sometimes, the IIW-weld defect reference collection is used, beside which the instructor usually has his own collection of typical examples, supplemented with process-specific radiographs. ASTM has a reference set of defects in castings available.

There are incidental initiatives to introduce classification of film-interpreters by level, in a system comparable to the qualification of NDT-personnel. Some countries have already implemented such a system.

## 15.3 Reference radiographs

The two main areas for the application of radiography are weld examination and examination of castings. Radiography is also used to check complex assemblies for proper construction, and for many other technical applications. The following selection of radiographs illustrates the wide variety of possibilities for detection possibilities of defects or errors.

### Weld inspection:

The following examples are from the booklet published by GE Inspection Technologies, called “Radiographer’s Weld Interpretation Reference”

*Note: All of these examples illustrating a variety of defects in welds are also issued on poster format (60 x 90 cm) by GE Inspectio technologies.*

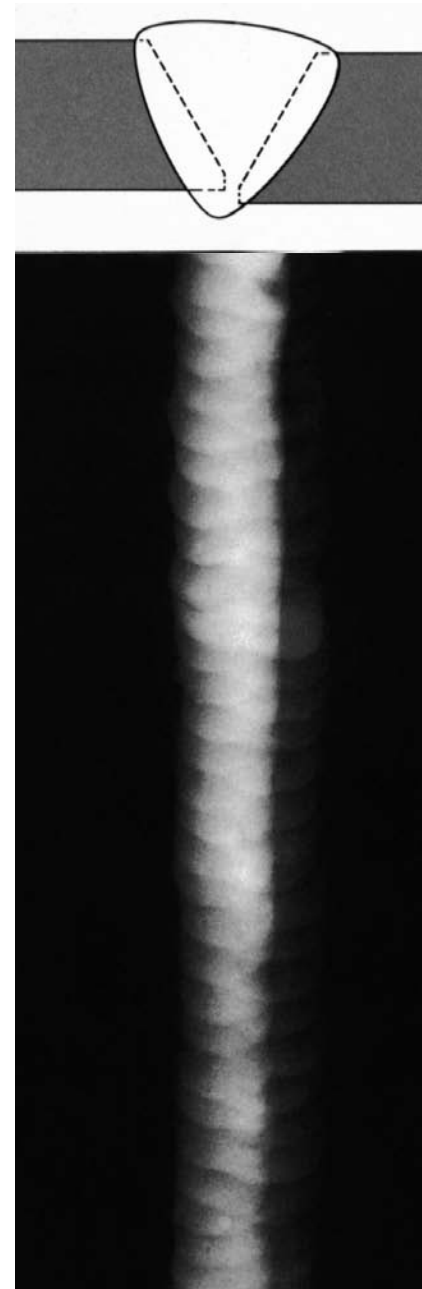

*Offset or mismatch (Hi-Lo).  
An abrupt change in film density across the width of the weld image*

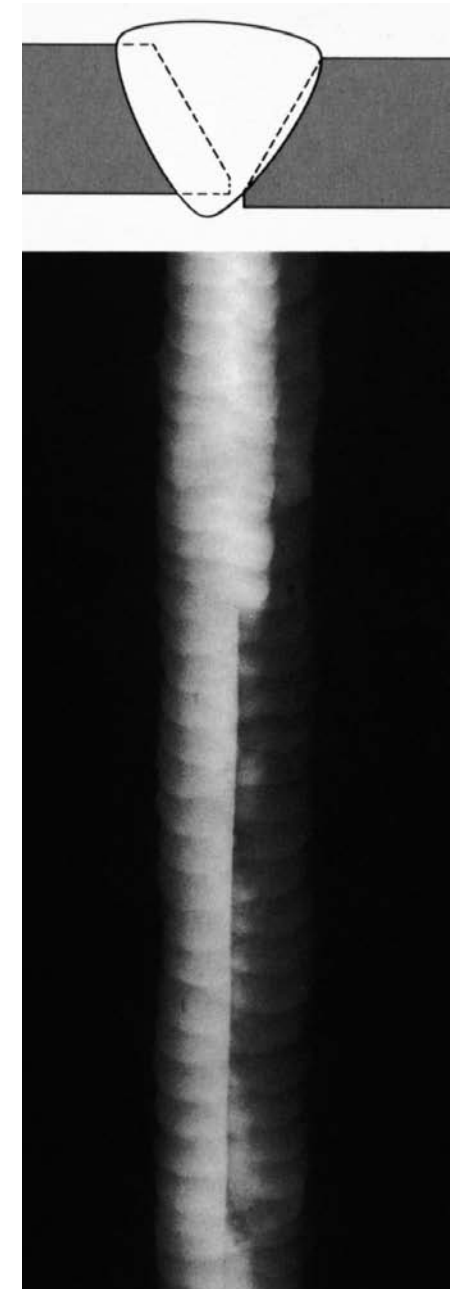

*Offset or mismatch with Lack of Penetration (LOP).  
An abrupt density change across the width of the weld image with a straight longitudinal darker density line at the centre of the width of the weld image along the edge of the density change.*

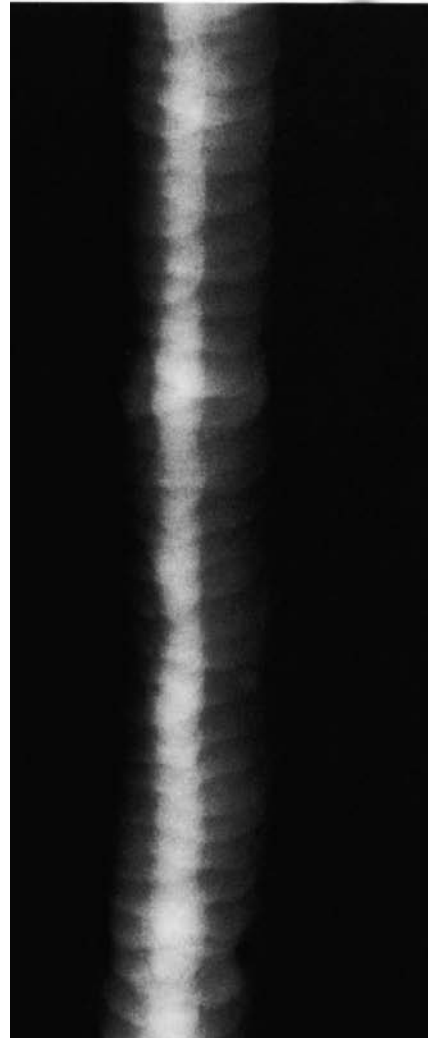
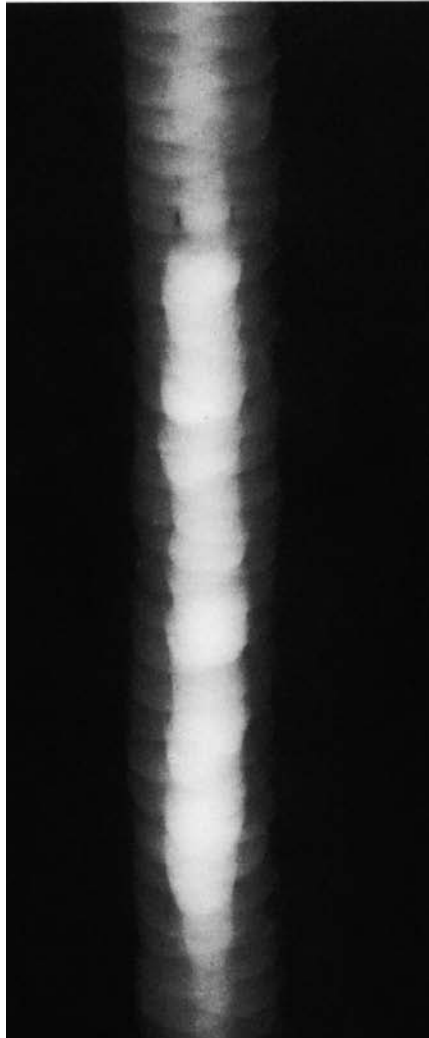
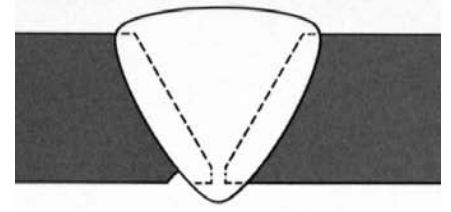
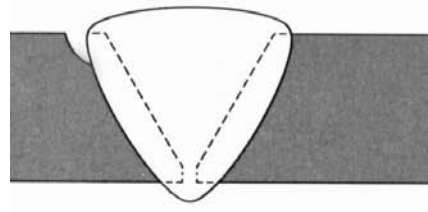
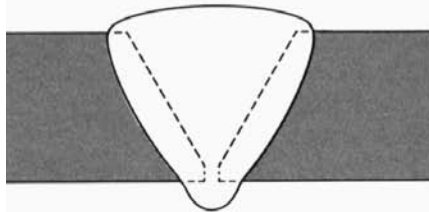
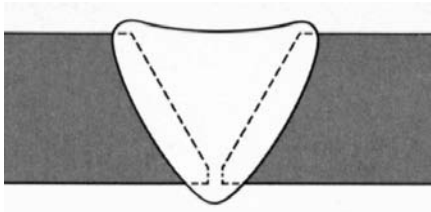

*External concavity or insufficient fill.  
The weld density is darker than the density of the pieces welded and extending across the full width of the weld.*

*Excessive penetration.  
A lighter density in the centre of the width of the weld image, either extended along the weld or in isolated circular drops.*

*External undercut.  
An irregular darker density along the edge of the weld image. The density will always be darker than the density of the pieces being welded.*

*Internal (root) undercut.  
An irregular darker density near the centre of the width of the weld image and along the edge of the root pass image.*

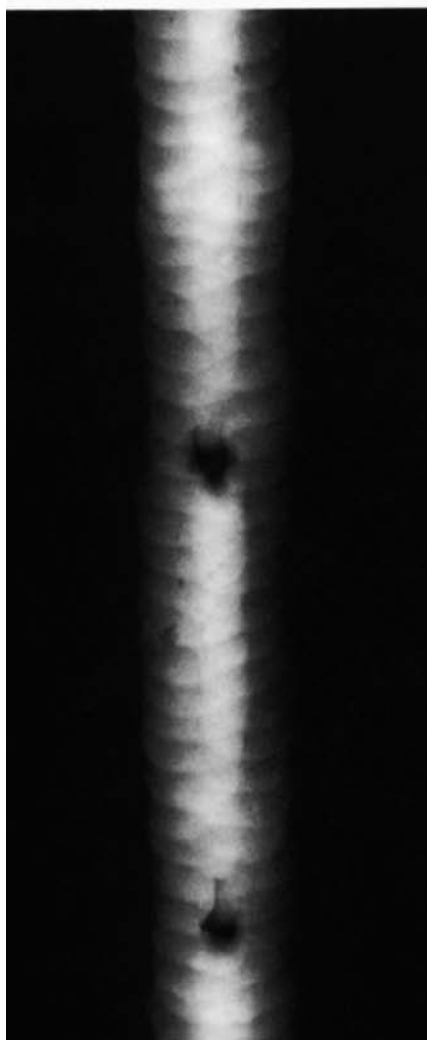
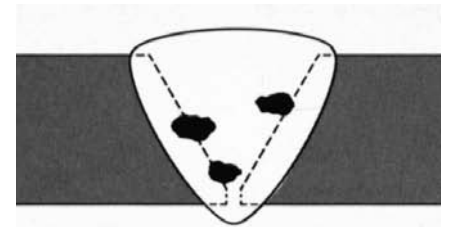
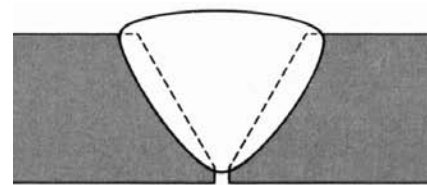
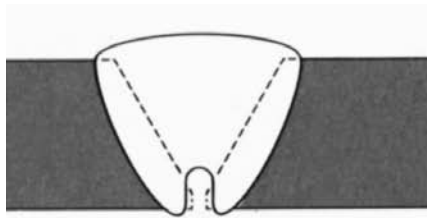
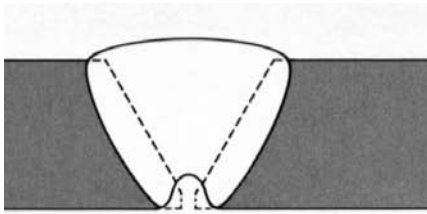

*Internal concavity (suck back).  
An elongated irregular darker density with fuzzy edges, in the centre of the width of the weld image.*

*Burn through.  
Localized darker density with fuzzy edges in the centre of the width of the weld image. It may be wider than the width of the root pass image*

*Incomplete - or Lack of Penetration (LoP)  
A darker density band, with very straight parallel edges, in the center of the width of the weld image.*

*Interpass slag inclusions.  
Irregularly-shaped darker density spot, usually slightly elongated and randomly spaced.*



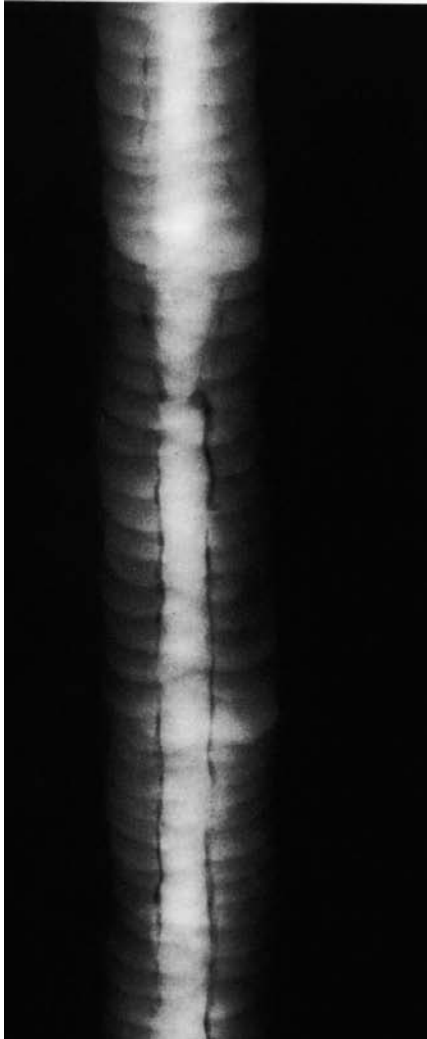
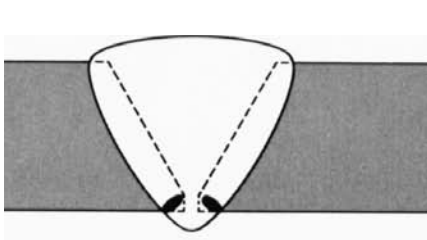

Elongated slag lines (wagon tracks).  
Elongated parallel or single darker density lines, irregular in width and slightly winding lengthwise.

130

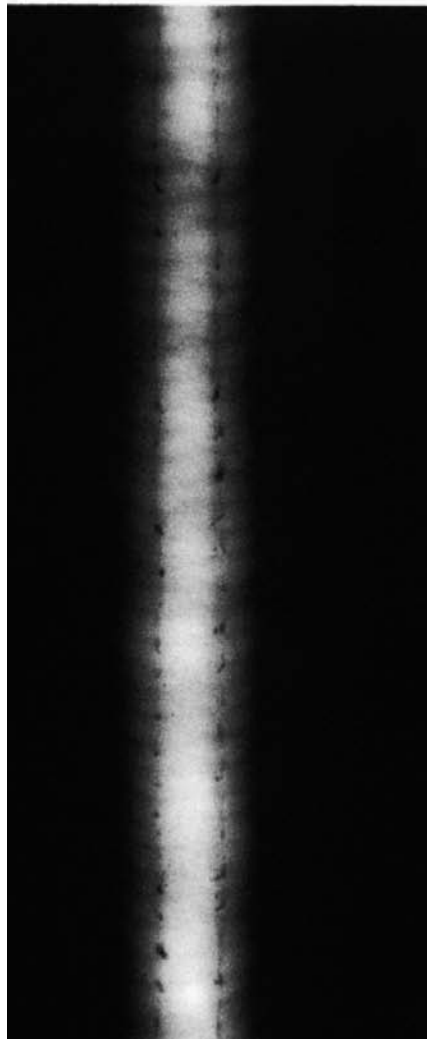
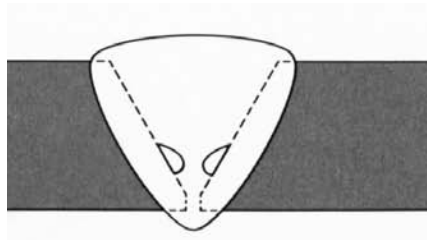

Lack of side wall fusion (LOF).  
Elongated parallel, or single, darker density lines sometimes with darker density spots dispersed along the LOF-lines which are very straight in the lengthwise direction and not winding like elongated slag lines

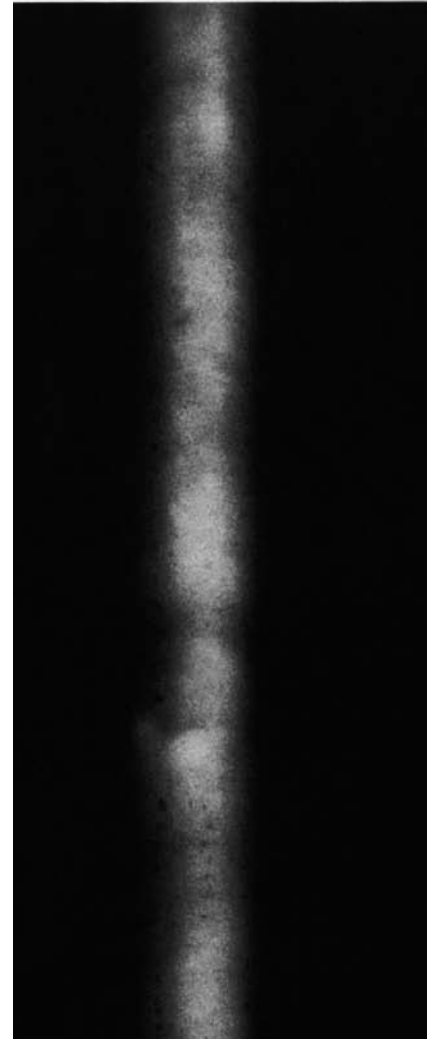
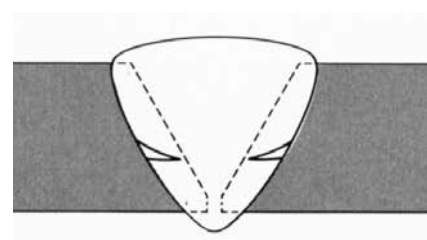

Interpass cold lap  
Small spots of darker densities, some with slightly elongated tails in the welding direction.

131

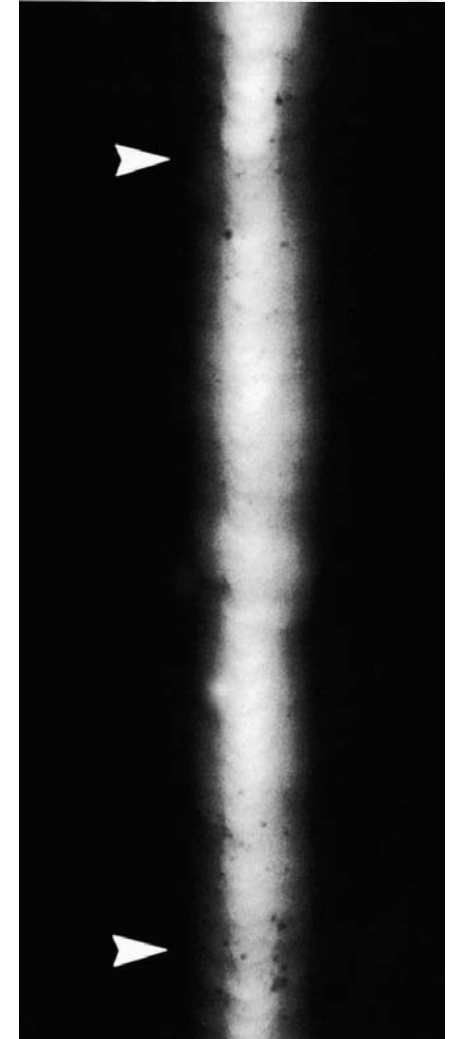
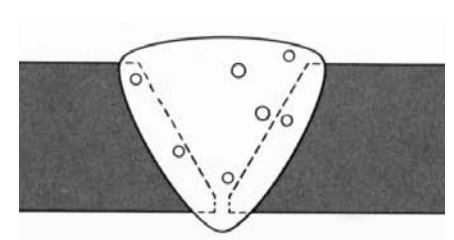

Scattered porosity.  
Rounded spots of darker densities random in size and location.





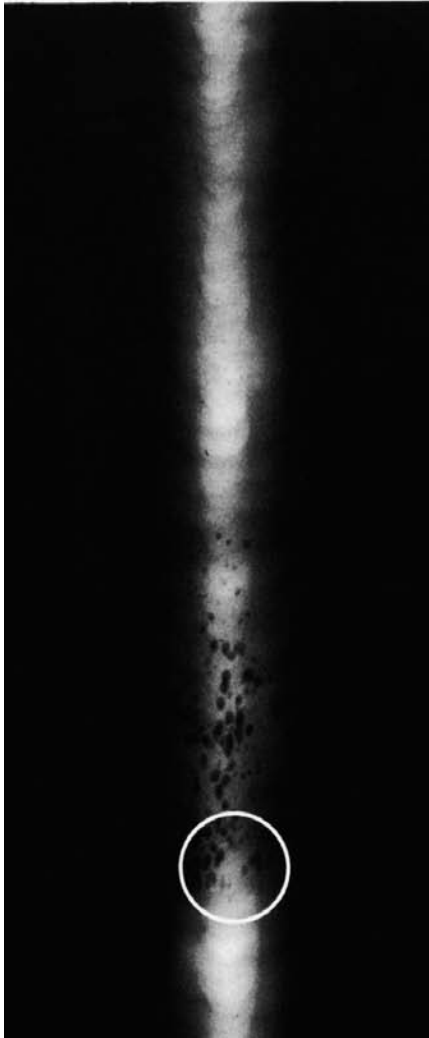
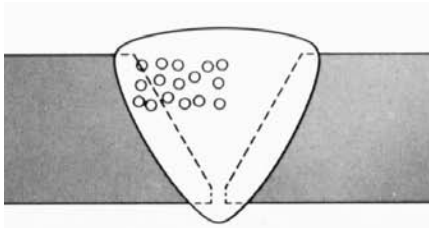

*Cluster porosity.  
Rounded or slightly elongated darker density spots in clusters with the clusters randomly spaced.*

132

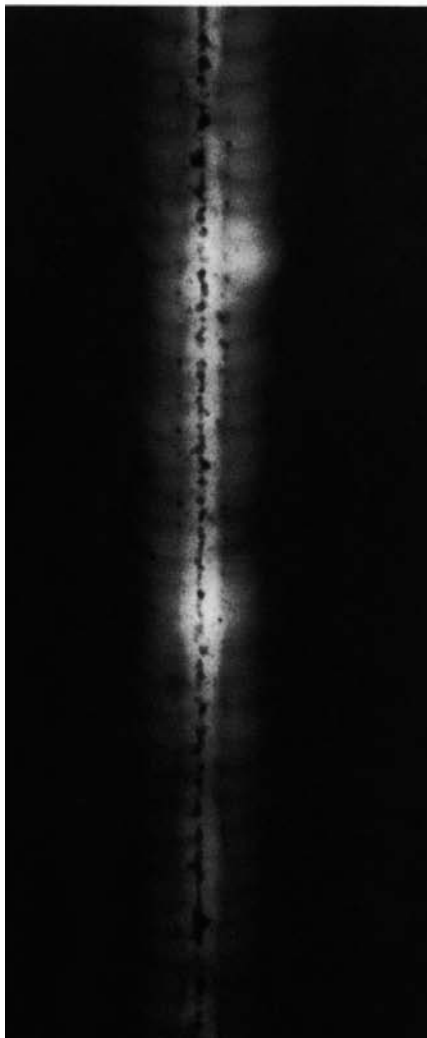
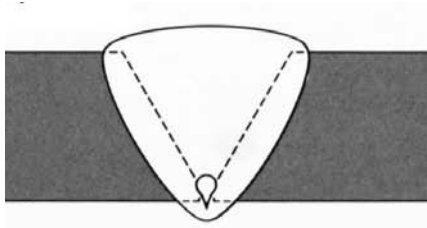

*Root pass aligned porosity.  
Rounded and elongated darker density spots that may be connected, in a straight line in the centre of the width of the weld image.*

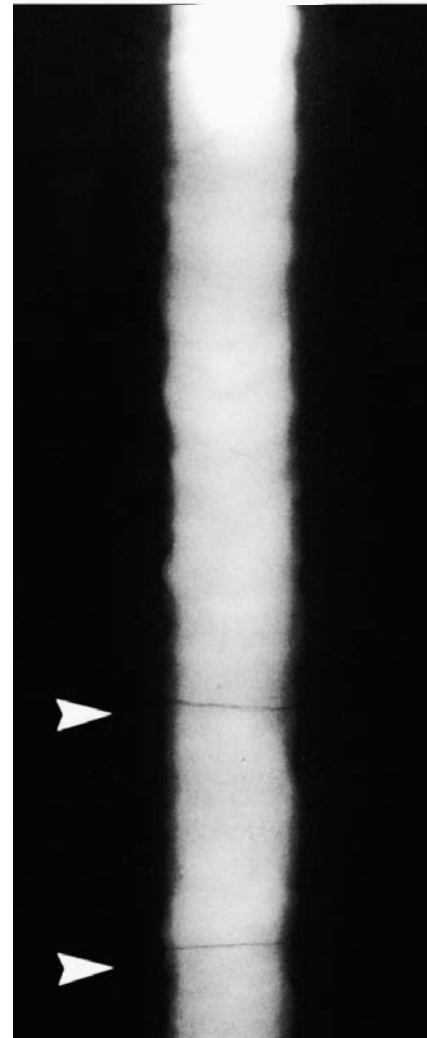
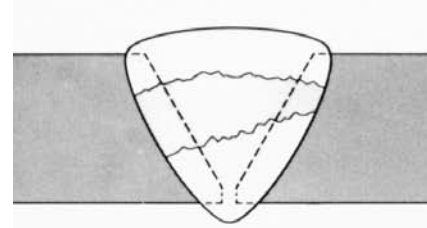

*Transverse crack  
Feathery, twisting lines of darker density running across the width of the weld image.*

133

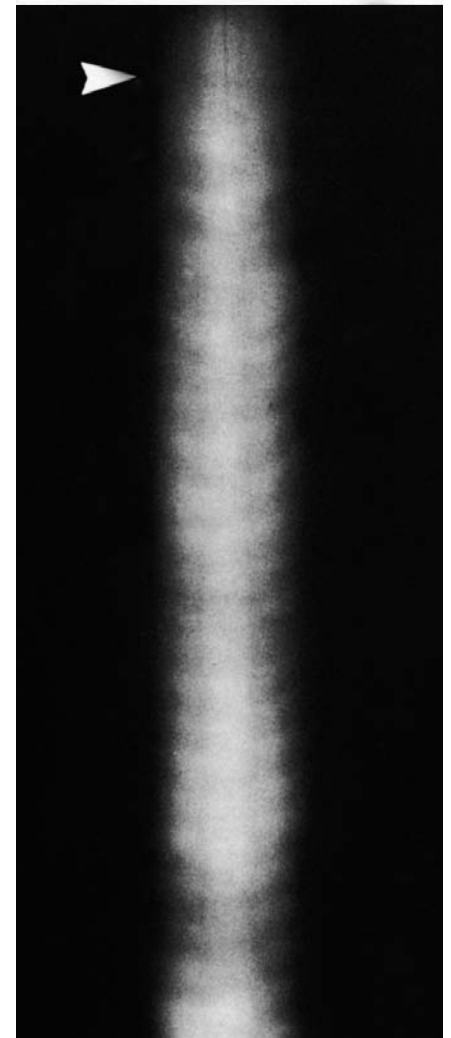
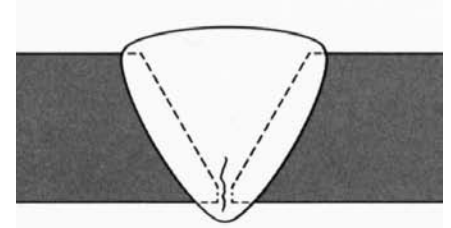

*Longitudinal crack  
Feathery, twisting line of darker density running lengthwise along the weld at any location in the width of the weld image.*





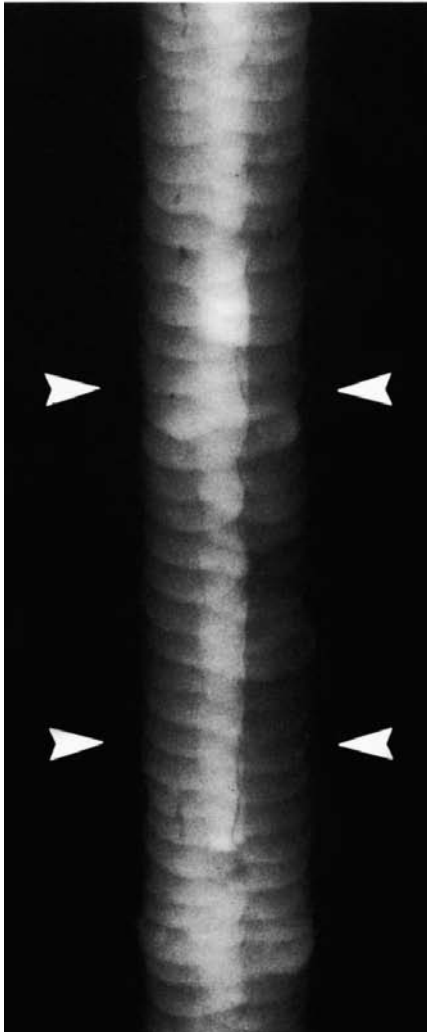
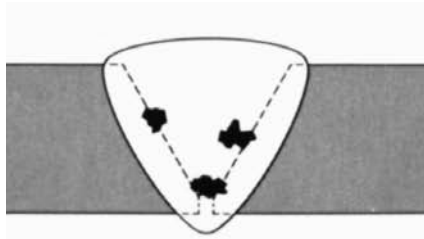
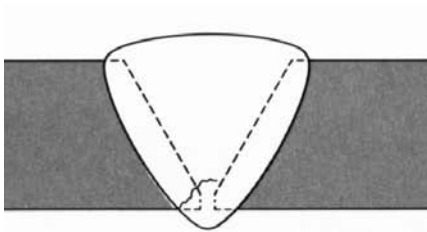

*Longitudinal root crack.  
Feathery, twisting lines of darker density along the edge of the image of the root pass. The "twisting" feature helps to distinguish the root crack from incomplete root penetration.*

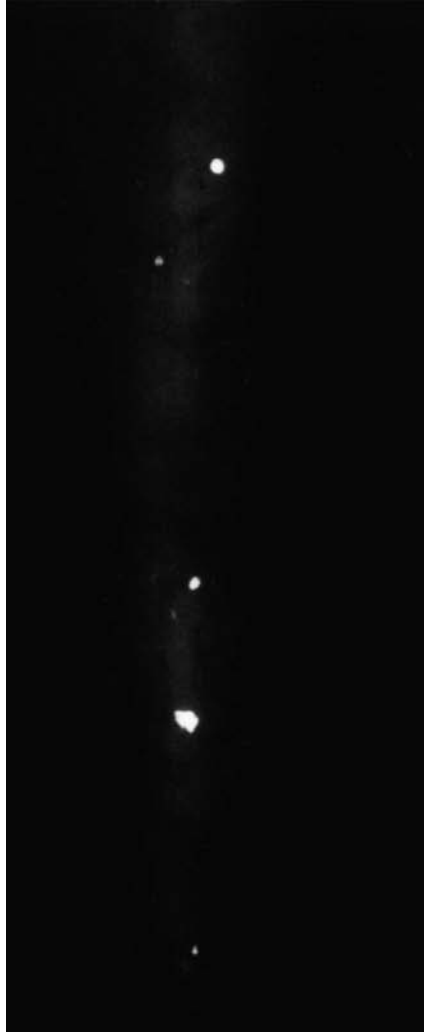

*Tungsten inclusions.  
Irregularly shaped lower density spots randomly located in the weld image.*

### Casting radiography

For the interpretation of X-ray films of castings, thorough knowledge of the specific manufacturing process is required. The type of defects in castings varies for the different types of materials and casting processes. Figures 15-1 and 15-2 show X-rays of complex castings. These radiographs were made to check the overall shape and possible presence of casting defects.

As it solidifies during the casting process, metal contracts and unless precautions are taken shrinkage cavities can occur inside the casting.

These can take various forms, such as piping/worm-holes, (figure 15-3), sponginess or filamentary cavities, depending on the rate at which the metal has solidified. When the contracting spreads slowly through the metal, filamentary shrinkage (figure 15-4) or even inter-crystalline shrinkage (figure 15-5) may occur, while if the solidification front shifts rapidly, shrinkage cavities tend to occur (figure 15-6).

Gas cavities in the form of porosity or larger gas holes can occur either due to a damp mould or release of gas from the molten metal, and can be particularly troublesome in cast light alloys (figure 15-7). Cracks can also occur in castings.

If they are formed while the metal is still semi-solid they are usually called "hot tears" (figure 15-8); if they occur when the metal has solidified, they are called "stress cracks" or "cold tears" (figure 15-9).

A collection of radiographs of defects in iron/steel castings is provided in ASTM E446, and for aluminium in ASTM E155.

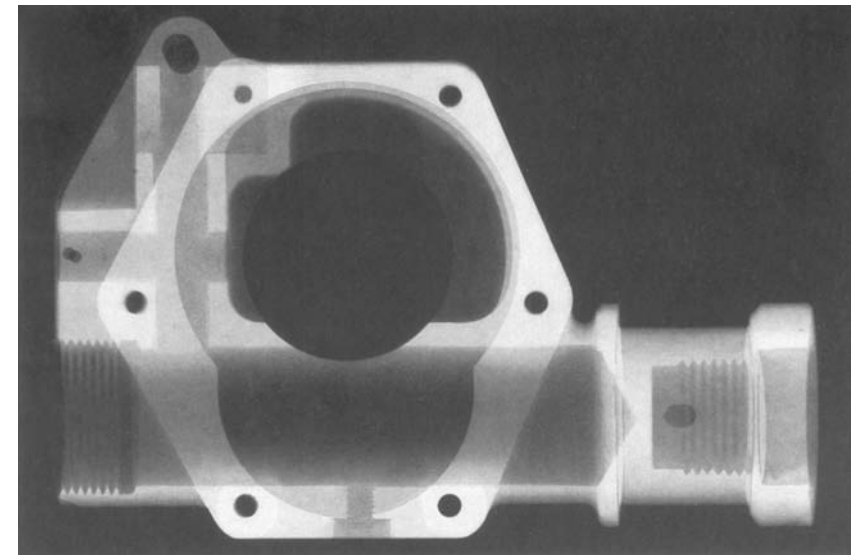

Fig. 15-1. Radiograph of an aluminium casting



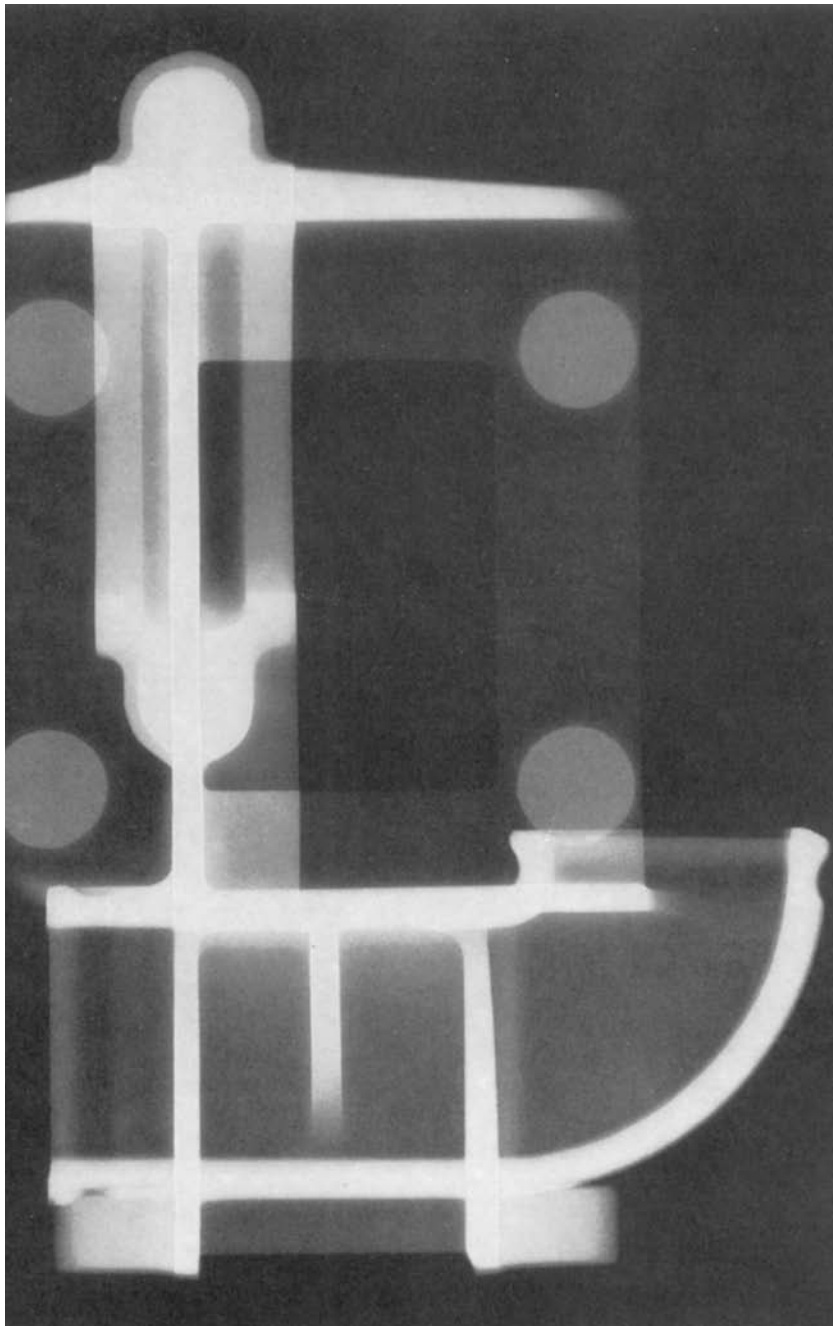

Fig. 15-2. Radiograph of an aluminium precision casting. Exposure on D2 film at 75 kV/5 mA/3.5 min./film-focus distance 100 cm

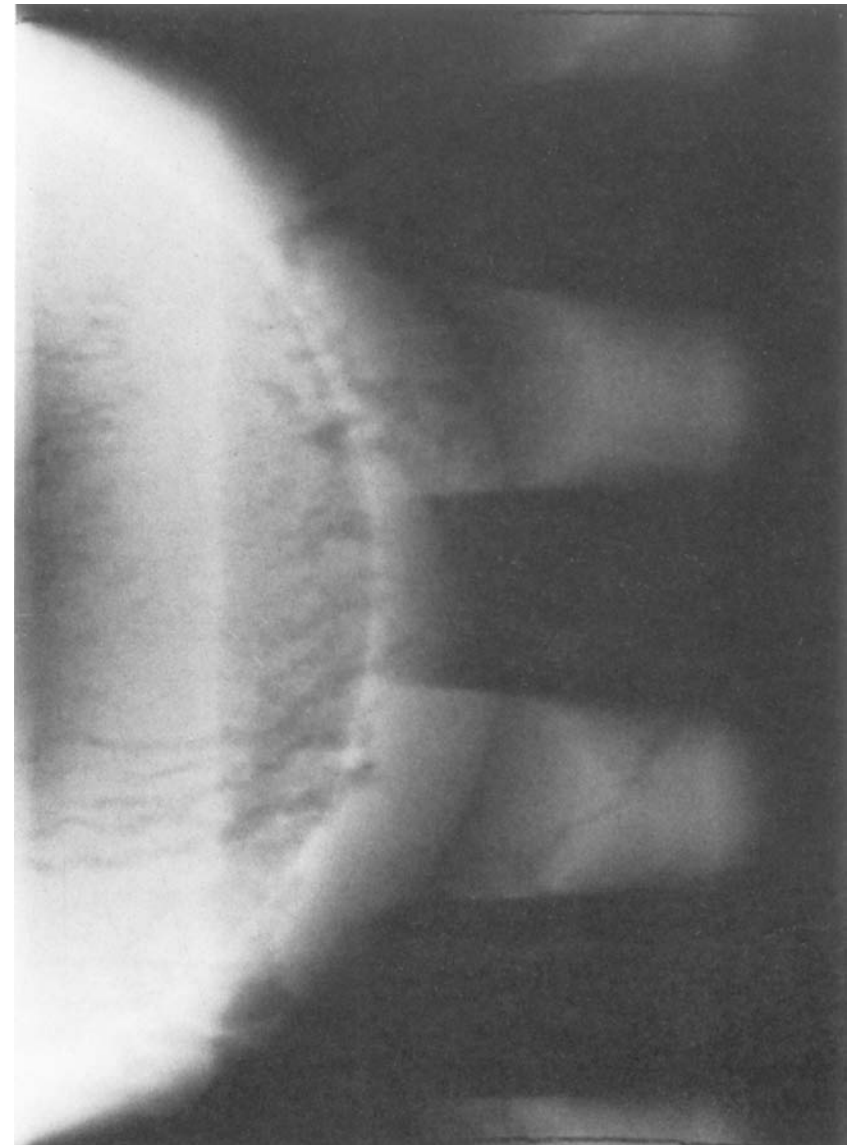

Fig. 15-3. Shrinkage (worm-hole cavities) in a (high heat conductive) copper casting



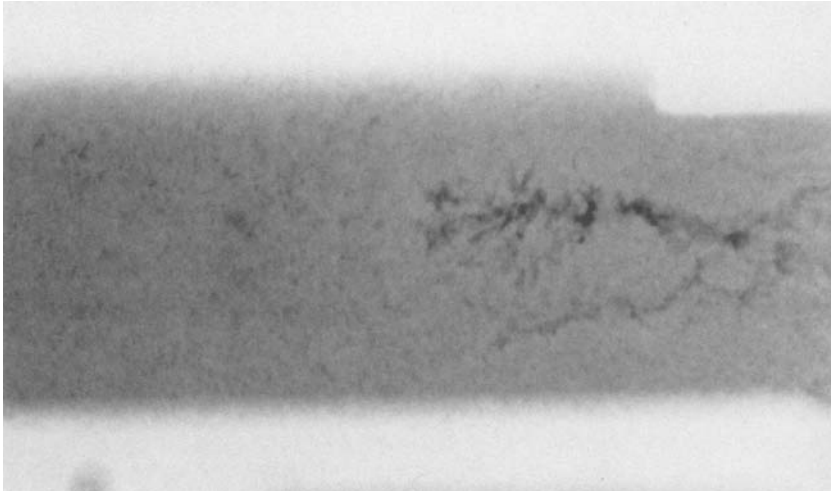

Fig. 15-4. Filamentary shrinkage in an aluminium alloy casting

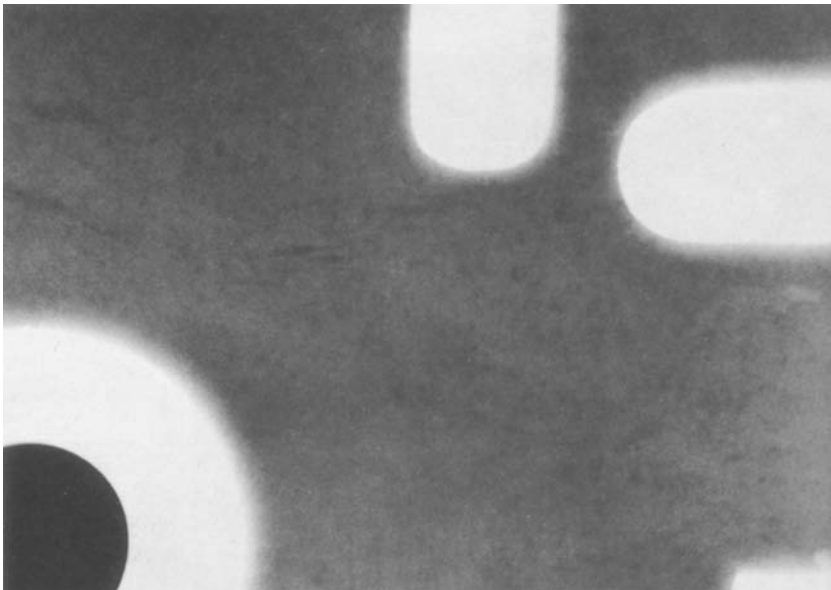

Fig. 15-5. Micro shrinkage (layer porosity) in a magnesium alloy casting

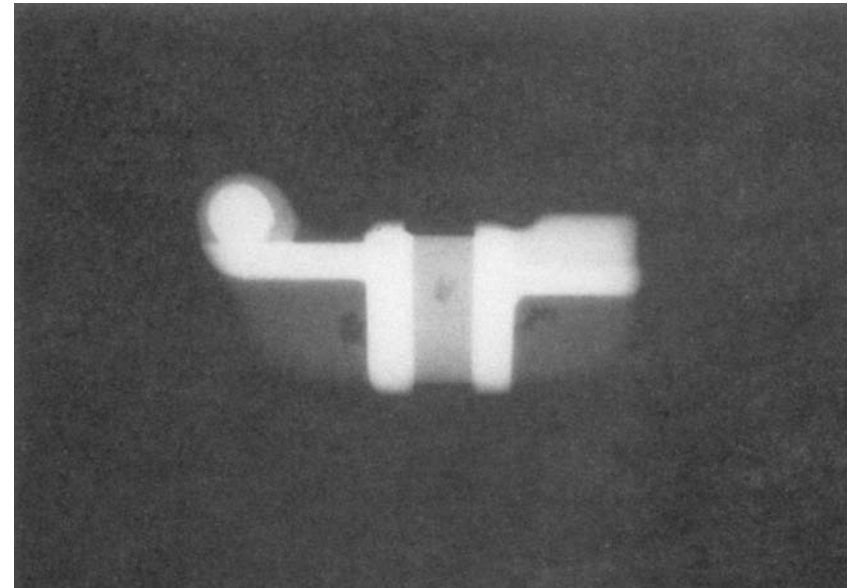

Fig. 15-6. Shrinkage cavities in a bronze casting

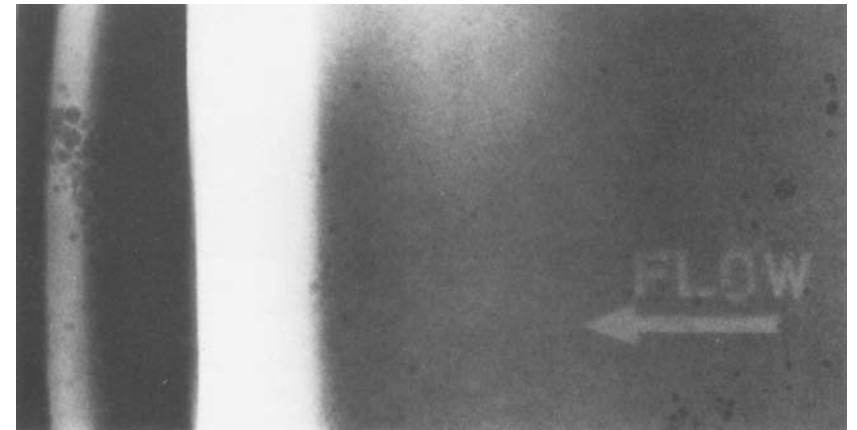

Fig. 15-7. Gas-holes and porosity in an aluminium alloy casting



Fig. 15-8. Hot cracks (hot tears)

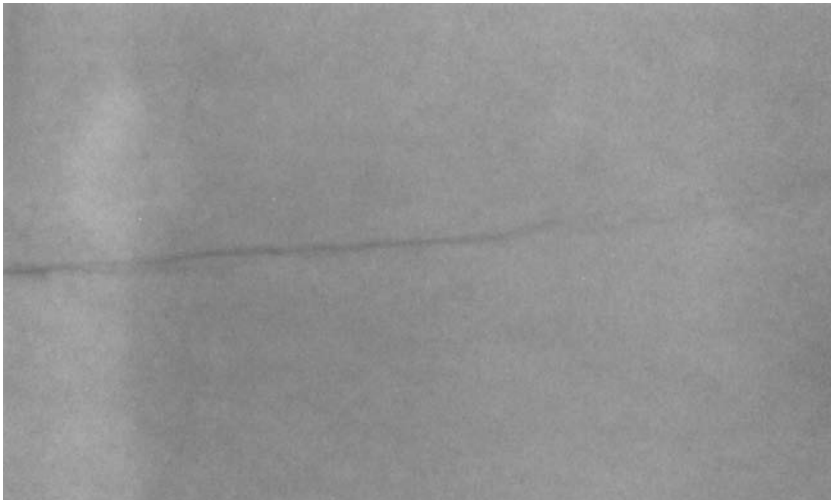

Fig. 15-9. Stress cracks (cold tears)

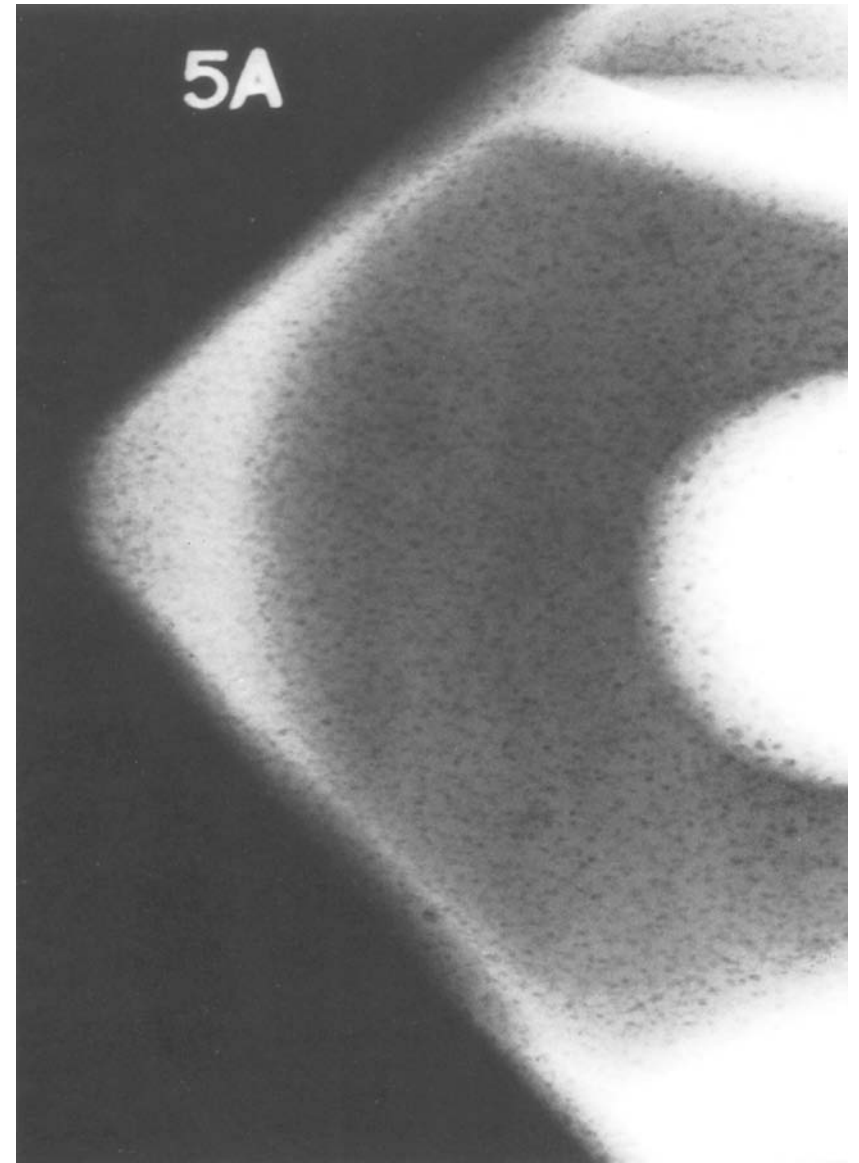

Fig. 15-10. Radiograph of an aluminium casting with coarse porosity  
Exposure on D7 film at 60 kV/5 mA/15 sec, film-focus distance 100 cm



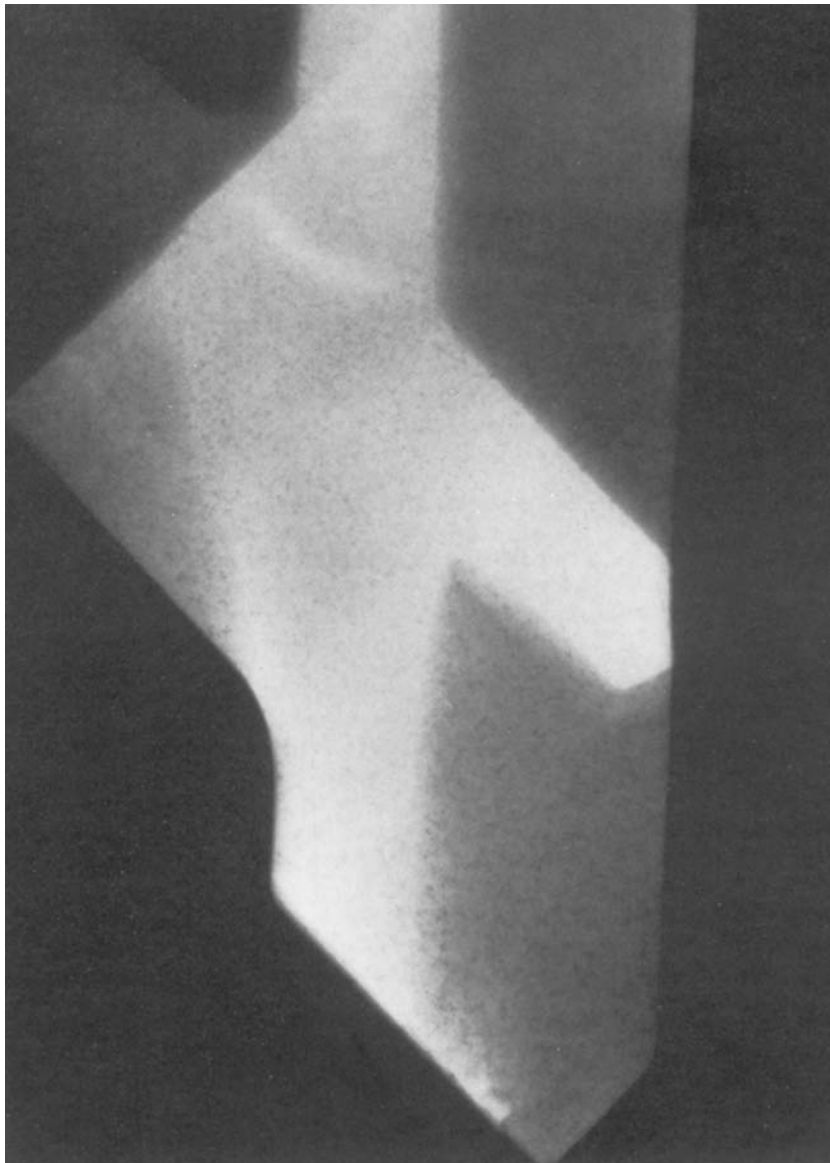

Fig.15-11. Radiograph of 25mm thick aluminium-copper alloy casting with gas porosity  
Exposure on D7 film at 140 kV/5 mA, film-focus distance 100 cm

### Examination of assembled objects

In addition to radiography for detection of defects in welds and castings, it can also be applied to check for proper assembly of finished objects as figures 15-12 and 15-13 illustrate

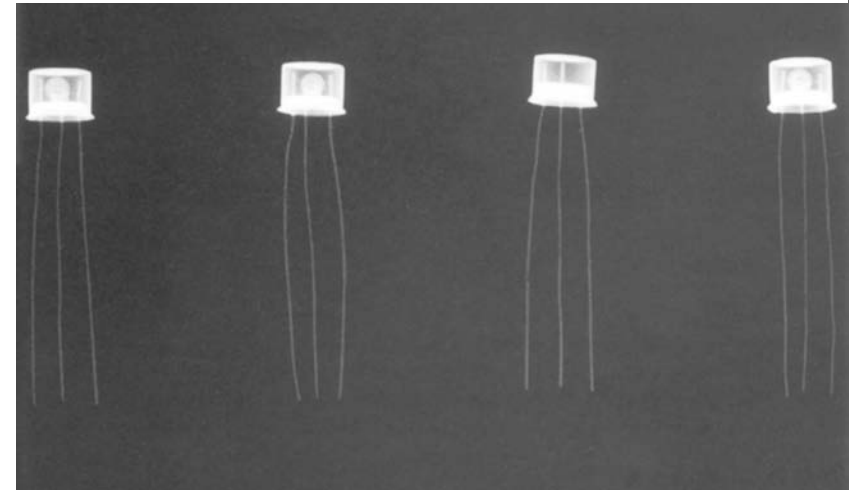

Fig. 15-12. Radiograph of transistors  
Exposure on D2 film with 27  $\mu$ m lead screens at 100 kV/5 mA/2 min film-focus distance 70 cm.

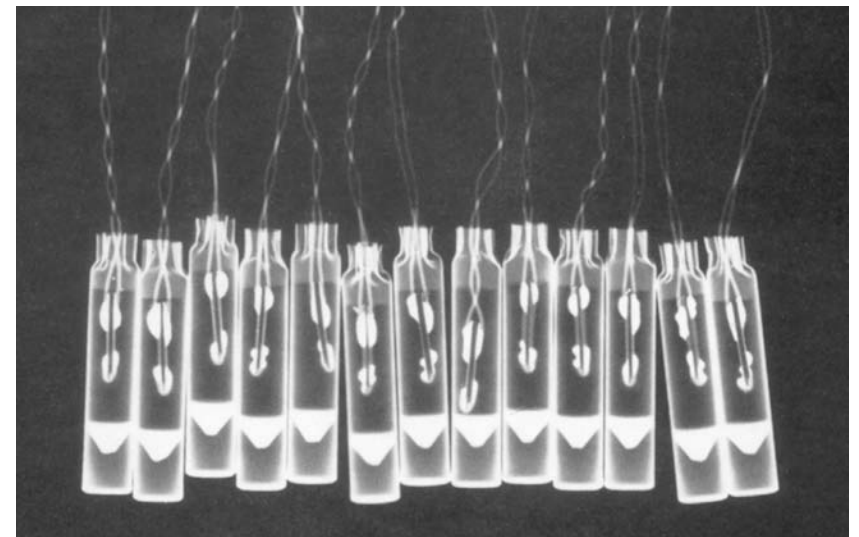

Fig. 15-13. Radiograph of electric detonators, taken to check details of assembly





Digitally enhanced radiograph of a "mermaid/man".  
The radiograph negated a myth by demonstrating that it concerns  
a man-made creature.  
©The British Museum

## 16 Digital Radiography (DR)

### 16.1 Introduction to DR

As in other NDT methods, the introduction of microprocessors and computers has brought about significant changes to radiographic examination. Chapter 17 describes a number of systems such as Computed Tomography (CT), radioscopy and X-ray microscopy that have been made possible by newly developed technology which involves rapid digital processing of vast quantities of data. But as this chapter will show, computer technology has also entered the field of conventional image forming radiography, as applied in industry.

The driving force was the medical world where digital radiography already earned its credits and has become standard technology. Along with a few other companies, GE Inspection Technologies and its affiliated suppliers developed a variety of digital systems with a wide range of computer-aided NDT applications. Digital radiography partly replaces conventional film and also permits new applications. The growing number of available standards, norms, codes and specifications – essential for industrial acceptance and application – supports this tendency.

Although the process itself is different from film radiography, DR resembles traditional radiography to a large extent. The optical impression of the X-ray images is similar so that RT trained personnel can quickly adopt this new technology and adapt to it without great efforts. Moreover the images can be interpreted in analogy to film.

Digitisation of traditional radiographs although not real digital radiography, uses the same digitisation technology, presentation on a display of a work station and image adjustment, and therefore is part of this section too. Digitisation of film is done for the purpose of archiving and/or image enhancement (adjustment).

Two main methods of real filmless digital imaging can be distinguished:

1. digital radiography by means of phosphor coated semi-flexible imaging plates (compared with flexible film) in combination with computer processing, so-called "Computed Radiography", CR for short
2. digital radiography with rigid flat panel- or flat bed detectors and instant computer processing, referred to as "Digital Radiography", DR for short, and considered as the genuine (true) DR method and sometimes in the field referred to as "Direct Radiography".

Each method has differing strengths, advantages and limitations that should be evaluated in terms of specific application, inspection requirements and economics: capital, human investment and productivity (number of exposures in a certain time).





The major parameters to compare film to digital radiography are spatial resolution, contrast sensitivity and optical density range. The major merits of digital radiography compared to conventional film are:

- Shorter exposure times and thus potentially safer
- Faster processing
- No chemicals, thus no environmental pollution
- No consumables, thus low operational costs
- Plates, panels and flat beds can be used repeatedly
- A very wide dynamic exposure range/latitude thus fewer retakes
- Possibility of assisted defect recognition (ADR)

Despite all these positive features, the image resolution of even the most optimised digital method is (still)not as high as can be achieved with finest grain film. A few other limitations are also explained in this chapter.

## 16.2 Digital image formation

In conventional (film) radiography, the human eye is used to examine a physical record of the radiographic image, which has recorded the intensity of X-rays incident on the film as varying degrees of opacity (shades of grey between black and white). In digital imaging the intensity of X-rays is first measured point by point and then individually digitised and converted into many (e.g. 12 bit = 4096 levels) discrete grey values including their corresponding coordinates. This recording process is known as mapping; a map consists of many (millions) discrete measuring points with their individual grey levels. Finally, these grey levels and their coordinates are displayed to form a coherent image on a video screen, or printed, as a collection of picture elements (“pixels”) for examination by the human eye.

Because of the 1-to-1 correspondence between each final image pixel and the discrete measurement area (sensor size), the areas on a digital detector are also commonly referred to as pixels. For digital radiography using panel, flat bed or line array detectors this process of digitisation with assigned grey levels is done at once, at the detector itself. In case of imaging plates the digitisation and grey level assignment is done in the so-called “reader”, see section 16.4. The mapping process allows data to be measured and stored from a much wider dynamic range than the eye can normally perceive. After an image has been stored, different maps can later be applied to show different thickness ranges, without affecting the original measurements. These maps can be linear or non-linear: for example, a logarithmic map is sometimes used to more closely mimic the response of conventional films.

## 16.3 Digitisation of traditional radiographs

Although the image forming of traditional film has nothing to do with digital radiography, digitisation of such films makes use of a major part of the technology and hardware also used for CR and DR and as such is part of this chapter of the book. Storing and archiving of chemically processed X-ray films not only demands special storage conditions, see section 10.7, but also takes up quite a bit of space.

Digitisation of these films provides an excellent alternative that also prevents degrading. Special equipment has been developed for this purpose. Current digitisation equipment actually consists of a fast computer-controlled flat bed scanner that scans the film spot wise in a linear pattern, identical to the formation of a TV image, measuring densities while digitising and storing the results.

The spot of the laser beam can be as small as 50  $\mu\text{m}$  in diameter (1  $\mu\text{m}$  = 1 micron, equivalent to one thousand's of a millimetre), but the equipment can be adjusted for a coarser scan, for example 500 microns, to achieve shorter scanning times. The values measured are compared to a calibrated density scale and processed digitally. Density variations between 0.05 up to 4.7 can be measured.

The scanner has part of its technology in common with the CR film scanner, of which the schematic principle is shown in figure 3-16. Contrary to the CR film scanner which measures reflected (stimulated) light, the density measurement in the film digitiser takes place in transmission mode using a scanning light beam synchronised with a light detector.

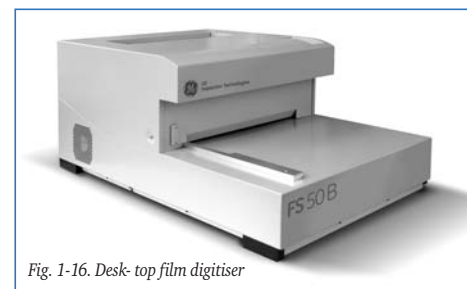

Fig. 1-16. Desk-top film digitiser

Usually the density (blackening/blackness) of a film is digitised in 12 bits, equal to 4096 steps or grey levels. For convenience, these over 4000 levels are divided by 1000, resulting in relative digital density values from 0 to 4. This provides a mean comparison with traditional film density values.

GE Inspection Technologies supplies film digitisers, made by Agfa. A desk top version is shown in figure 1-16. In these scanners, films with a maximum width of 350 mm can be digitised in a single run. Even for the smallest laser beam spot size of 50  $\mu\text{m}$ , approximately 4 mm of film (in length) can be scanned per second, so for the largest standard film size (350 x 430 mm) this process would take approximately 2 minutes to complete. Scanners exist without length limitation of film, and adapters exist for digitisation of roll (stripe) films.

Apart from greatly reduced storage space and (almost) deterioration-free archiving, digitising also makes it possible to (re)analyse the film's images on a computer screen (see work station in figure 33-16), with the possibility of electronic image adjustment (enhancement), see section 16.12. Thus defect indication details not discernible on the original film using a viewing screen can be made visible.

For use in laboratory environments only, high-resolution film digitisation systems exist that use a scan spot size as small as 10  $\mu\text{m}$ . This is an inherently time consuming process but enables detailed analysis of particular film areas, e.g. to make tiny cracks visible at the work station.



Because scanners vary widely in resolution, dynamic range, and ability to scan dense films, evaluation is required to ensure that adequate scanning fidelity is achieved. Depending on selected resolution many Megabytes are needed to store a single film, see paragraph 16.12. Archiving of a digitised film, identical to CR- and DR images, is usually done on an optical mass storage facility e.g.: CD-ROM, DVD etc. For uniform application of film digitisation norm EN 14096 has been issued.

## 16.4 Computed Radiography (CR)

Digital radiography using storage phosphor plates is known as “Computed Radiography” or CR for short. This “filmless” technique is an alternative for the use of medium to coarse-grain X-ray films, see the graph in figure 27-16. In addition to having an extremely wide dynamic range compared to conventional film, CR technique is much more sensitive to radiation, thus requiring a lower dose, see figures 8-16 and 27-16. This results in shorter exposure times and a reduced controlled area (radiation exclusion zone).

### Two-step digital radiography

CR is a two-step process. The image is not formed directly, but through an intermediate phase as is the case with conventional X-ray films. The image information is, elsewhere and later, converted into light in the CR scanner by laser stimulation and only then transformed into a digital image. Instead of storing the latent image in silver-halide crystals and developing it chemically, as happens with film, the latent image with CR is stored (the intermediate semi-stable phase) in a radiation sensitive photo-stimulable phosphor layer. This phosphor layer consists of a mix of bonded fine grains of Fluor, Barium and Bromium doped with Europium.

### The CR imaging plate

The phosphor layer has been applied to a flexible carrier and been provided with a protective coating. An additional laminate layer mainly determines the mechanical properties such as flexibility ( CR imaging plates are not as flexible as X-ray films). Such plates can be used in a temperature range from -5° C to +30° C. Figure 2-16 shows the layered structure of this type of plate, which is generally called an imaging plate or sometimes (wrongly) imaging screen.

*Note: Screens in the world of NDT, made of lead or another metal, are used to intensify the effect of incident radiation or to reduce the effect of (scattered) radiation.*

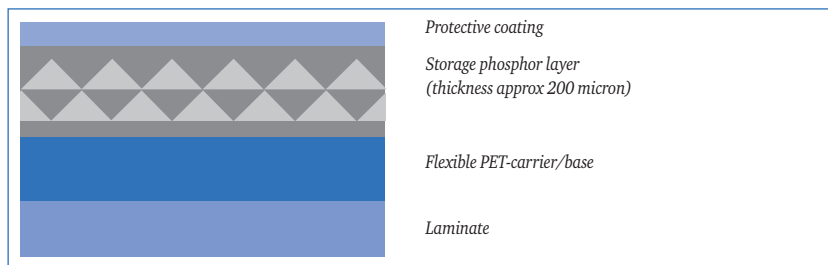
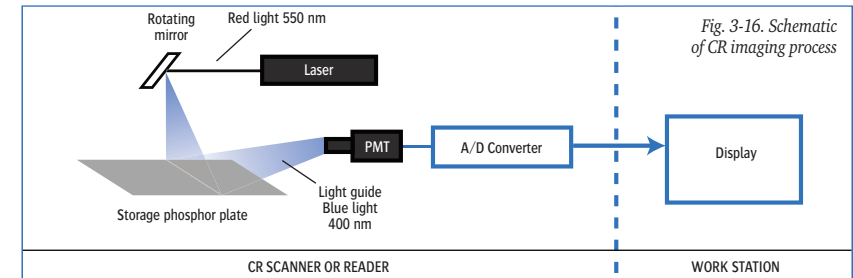

Fig. 2-16. Structure of the CR imaging plate

### Image development

As a result of incident X-ray or gamma ray radiation on the storage phosphor, part of its electrons are excited and trapped in a semi-stable, higher-energy state. This creates the latent image. These trapped electrons can be released by laser beam energy. This stimulation causes visible light to be emitted, which can then be captured by a PMT (Photo Multiplier Tube). The wavelength of the laser beam (550 nanometres) and that of the emitted visible blue light (400 nm) are of course different to separate the two .



The laser-scanning device used to scan (develop) the latent image contains the PMT and its electronics, which digitises the analogue light signal that is generated. This process as illustrated in figure 3-16 takes place in the phosphor scanner, or so called “CR scanner” or “reader”. The plate is scanned in a linear pattern similar to the formation of a TV-image and identical to the film digitisation process.



Fig. 4-16. Automated CR scanner



Fig. 5-16. CR drum type scanner

### Scanners-Readers

There are various types of scanners. In the most professional scanners, all that needs to be done is to insert the cassette in the input tray and the machine automatically completes the processing cycle. After completion of this process, including erasing the latent image, the cassette is released from the CR scanner and ready for re-use. Figure 4-16 shows a typical tower-type (man-size) automated scanner.

In smaller and portable desktop scanner models intended for use at remote locations e.g. on offshore platforms, the CR imaging plate is manually removed from the cassette and inserted into the scanner, which slightly increases the risk of the plates being damaged. In addition to flat bed CR scanners drum type scanners exist. Figure 5-16 shows an example. This scanner can handle unlimited lengths of CR plates.





Fig. 6-16. Opened CR cassette

For desktop scanners the cassette can be opened, as shown in figure 6-16. CR plates can be exposed to subdued light (< 10 lux: a candle creates 5 lux) for one minute with acceptable consequences for the image quality. The effect strongly depends on the type of the light source, e.g. tube light causes most damage to the latent image. The scanned image is ultimately or instantly made visible on a high-resolution monitor (computer screen) of the workstation, see figure 33-16.

Depending on the line distance selected, typically 50 or 100 microns, the plate speed (lengthwise progress) is 5 to 10 mm per second. This is similar to the speed of digitisation of a traditional film. In all scanners, the latent image on the plate is not only read but also subsequently erased (reset) which takes about one minute, and therefore the CR plate is almost immediately available for the next exposure.

### CR cassettes

Bare CR plates are nearly as pliable as film. They can be packed in paper or vinyl cassettes either with or without lead screens. These packages are still pliable. Technically the plates can be used many times (up to 1000 x), provided they are handled with utmost care while their surface despite a protective coating is very sensitive to touching and dirt. A single scratch can make the plate unsuitable for further use. Rigid cassettes developed especially for the NDT-market have built-in intensifying lead screens at the source side, and a second lead screen at the back to absorb radiation caused by backscatter. These multi-layer cassettes are not flexible anymore but can be reused more often than the flexible cassettes (even a few 1000 times).

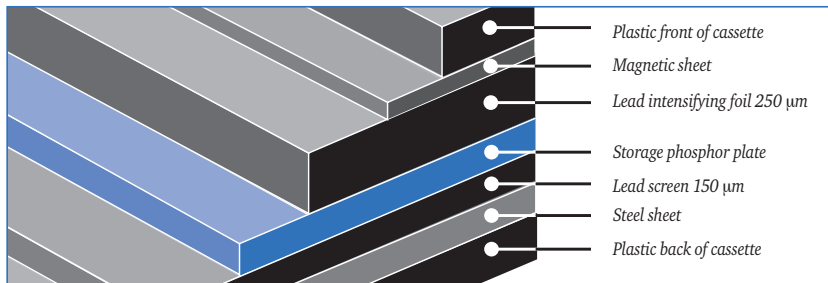

Fig. 7-16. Structure of a CR cassette with storage phosphor

Figure 7-16 shows a cross-section of the CR imaging plate in a rigid cassette. The steel and magnetic plates ensure that the various active layers are evenly and closely pressed together. For low energy exposures clip-type cassettes exist (to replace the steel- and magnetic plate) which also ensure intimate contact between the layers. The steel- and magnet plate would otherwise absorb the low energy radiation.

### Dynamic range – Exposure latitude

CR plates have an extremely wide dynamic range (exposure latitude). In practice the phosphor crystals on a CR plate cannot be saturated and react almost linearly to incident radiation, while in a conventional film the silver-halide crystals react exponentially, see the graph in figure 8-16.

As a result the dynamic range of a CR plate is much wider than for conventional film, which makes exposure times less critical, reducing re-shoots (re-takes), and allows various material thicknesses to be examined at the same time. The wide dynamic range can also be useful in case of under-exposure, this can be compensated for by a more sensitive read-out scan or image adjustment at the workstation.

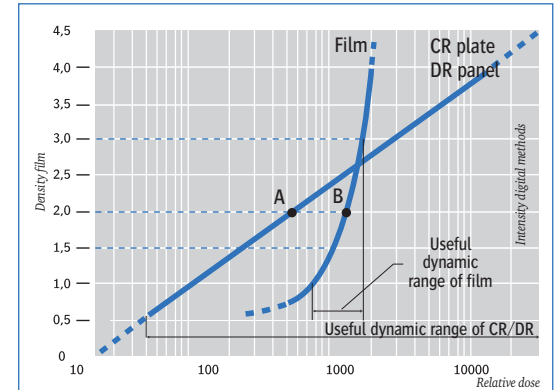

Fig. 8-16. Density/intensity versus dose for film and digital methods

This wide range is illustrated in figure 9-16. The images have been obtained from a stepwedge from 5 up to 25 mm thickness, in steps of 1mm. The digitised image of the film shows only a portion of the step wedge thicknesses, the logarithmic CR image shows all steps proportionally. The matching analogue records, at right handside of this figure, confirm this behaviour. Furthermore, those sensitivity (speed) of CR is five to ten times higher as well, compare point A and B at a density of 2, see also figure 27-16.

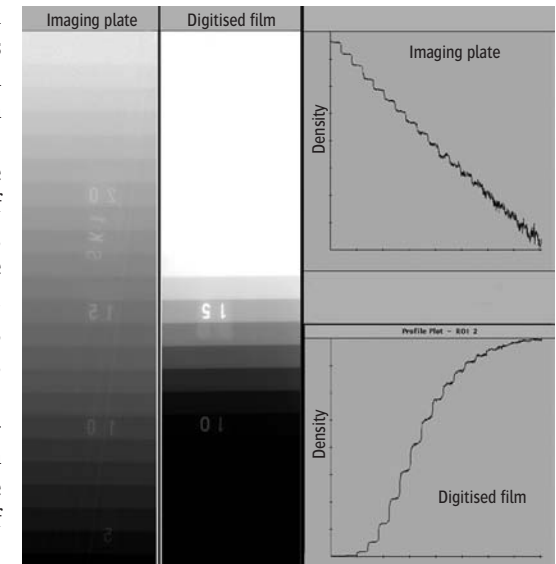

Fig. 9-16. Dynamic range of digitised film versus CR plate. (courtesy BAM Berlin)



### Exposure time and noise

In addition to the wide dynamic range the dose sensitivity (speed) of CR plates is five to ten times higher, compare point A and B in figure 8-16 at a density of 2 (see also figure 27-16). This allows for shorter exposure times or weaker sources, reducing the unsafe radiation area. Unfortunately, if a source with lower energy is chosen this will result in reduction of the image quality. Iridium192, with a lower energy than Cobalt60, requires a longer exposure time and this in turn reduces image quality due to the larger quantity of scattered radiation. For profile radiography applications (sometimes also called on-stream radiography) Iridium can replace Cobalt for pipes with a diameter up to 6" (150 mm), with still an acceptable image quality, or even 8" (200 mm) in case of thin wall pipe. The general rule is: the shorter the exposure time the less the scatter thus the better the image quality.

*Note: CR plates are more sensitive to low energy scatter (more noise) than conventional film. Careful filtering and collimation of the radiation and control of backscatter are vital to good CR.*

### Fading

After exposure the intensity of the stored information (cassette closed) naturally decays over time, resulting in some signal loss. Scanning within 1 hour of exposure provides the best results; typically 50% of the information is lost after 24 hours, dependent on the manufacturer of the plate. Fading is dependent on ambient temperature. To avoid image fading, scanning of the CR plate should not be delayed longer than necessary. In critical applications, where signal loss is expected due to delayed scanning, the plates can be exposed with a higher radiation dose to compensate for this information decay.

### Optimisation

To optimise the use of CR imaging plates in practice, a small handheld terminal as shown in figure 10-16 has been developed to superimpose specific project- and exposure information to the images. To this end the cassette contains a microchip which can receive (wireless) information from the terminal. On site and prior to the exposure the relevant information is sent from this terminal to the microchip on the cassette. The specific data is ultimately added to the image in the CR scanner. Once the data from the microchip has been erased the cassette is ready for re-use.



Fig. 10-16. Terminal for CR imaging plates

### Improvements

Due to ongoing efforts for improvement the image quality of the phosphor plate one has already achieved a level equal to the quality obtainable with a medium-grain conventional X-ray film, see figure 27-16. In fine-grain films, graininess is only a few microns, while in current (2008) phosphor plates this is considerably more (approximately 10 microns).

## 16.5 Genuine Digital Radiography (DR)

### One-step digital radiography

Digital radiography, DR for short, is also known as “direct” radiography to indicate the difference with CR, which is a two-step, and thus slower process. With DR technology, there is an immediate conversion of radiation intensity into digital image information.

Similar to common digital photo cameras, the radiographic image is almost immediately available. Exposure and image formation happen simultaneously, allowing near real-time image capture, with the radiographic image available for review only seconds after the exposure. Some systems even provide a true real-time (radioscopic) mode with display rates up to 30 images per second. This almost instant image formation is the reason that some consider DR the only “genuine” (true) method of digital radiography. This instant availability of results offers immediate feedback to the manufacturing process to quickly correct production errors.

### 16.5.1 Detector types

Many materials or combinations thereof are sensitive to the impact of ionising radiation. Over the years a considerable number of them proved to be efficient and commercially viable to create radiation detectors for NDT applications. As a result a wide variety of detector types are in use for formation of DR images. Often the application dictates the selection of a particular detection/sensor system dependent on pros and cons of such a system. The detectors can be characterised by detection method (direct versus indirect) and by geometry (linear versus two-dimensional: 2D). All the different detector types that are useful in industrial inspection applications have a wide dynamic range similar to CR plates, see figure 8-16.

### Direct versus indirect detection

All X-ray detection methods rely on the ionising properties of X-ray photons when they interact with matter. In direct detection (one-step) devices the amount of electric charge created by the incident X-rays is directly detected in semiconductor materials. In indirect (two-step) devices, the X-ray energy is absorbed by phosphorescent materials (known as “scintillators”) which emit visible light photons, and these photons are then detected by a photo detector being the second layer, thus being an indirect process.

The different active layers are illustrated in figure 11-16. Because many thousands of ionised charges can be created by a single X-ray, direct photo detectors must be both very sensitive and able to measure large amounts of charge to produce good image quality. The technologies for CMOS, scintillator materials and amorphous photo-detectors are relatively mature and used in many commercially available DR detector products.

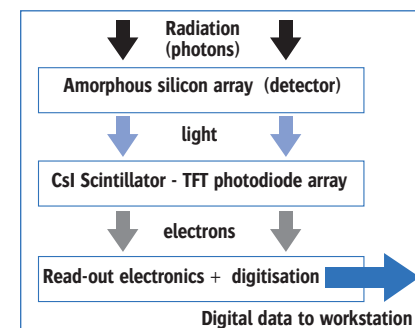

Fig. 11-16. Schematic of an indirect (two-step) flat panel detector





### Linear detectors

Linear detector arrays (LDAs) based on CMOS technology, as shown in figure 12-16, are commonly used in applications where a mechanical means provides a relative motion between the object being inspected and the X-ray beam. LDAs can be made in virtually any length. In practice active lengths are available up to over 1 metre and energy ranges from 100 kV to several MeV.



Fig. 12-16. CMOS linear detector array (courtesy Envision)

A common well-known application is airport luggage inspection, where a conveyor belt carries objects through a fan-shaped (collimated) X-ray beam and past a linear detector array as illustrated in figure 13-16. A series of row-like subimages from successive locations is then assembled to form a two-dimensional radiograph for interpretation.

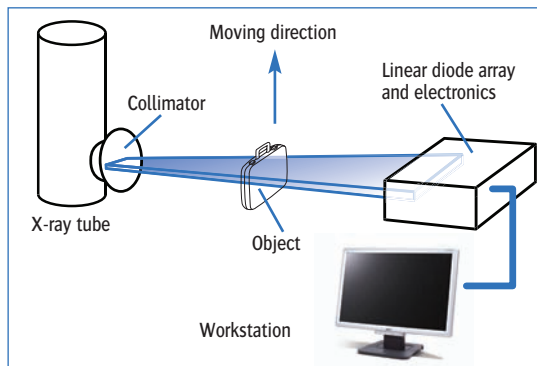

Fig. 13-16. Inspection set-up using a linear array

In NDT, similar linear arrays with small sensor elements are typically used in high speed testing machines for production inspection applications that incorporate either a manipulator or a conveyor to move parts past a stationary X-ray tube detector arrangement similar to figure 13-16.

A relatively new application is the inspection of circumferential welds (so-called girth-welds) during construction of pipe lines, either cross country or on lay barges, see section 16.11. For such systems CMOS type linear arrays are in use because of their efficiency, fast response and erase properties (< 0.2 msec) and last but not least their robustness; an essential requirement for application under adverse field conditions.

Linear (or curvilinear) arrays are also commonly used in CT applications.

Direct linear arrays using CdTe (Cadmium Telluride) and other semiconductor materials are now available, but most commonly linear arrays are of the indirect type with a scintillator material to convert incident X-rays into visible light and crystalline silicon photodiodes measuring the light. These analogue signals are subsequently digitised and converted into grey levels.

### 2D detectors

The “simplest” type of DR detector used in NDT is a two-dimensional array of detection “pixels” to measure incident X-ray intensity to directly create a radiographic image without the need for any motion of the component. Small 2D detectors typically use a photo detector array made from a crystalline silicon integrated circuit, optically mated to a powdered scintillator screen.

Both Charge-Coupled Devices (CCD’s) and Complimentary Metal-Oxide Semiconductor (CMOS) devices are used. Typically the screens use a powdered Gadolinium OxySulfide (GOS) material to convert the incident X-rays to visible light. These devices can have very good spatial resolution, but are often used with thin scintillator screens that can limit X-ray absorption efficiency (detection) over the full range of X-ray energies used in common NDT applications. Because they are made from singlecrystal silicon wafers, they are also limited in size. Thus detector designs that cover a larger area either require tiling of multiple devices or an x-y motion of a single small device to simulate over time the effect of a larger device.

Larger 2D detectors (up to the size of common X-ray films) are usually made from photo diode arrays of amorphous semiconductors. Some early direct detector products were made from relatively thick film of amorphous selenium, but these direct radiography detectors are no longer widely available for NDT applications. More common are the indirect devices with photo detector arrays made from very thin film of amorphous silicon, its schematic is shown in figure 11-16. These detector panels are available both with GOS screen scintillators and with thick layers of needle-crystal Caesium Iodide (CsI) grown directly on the photodiode arrays. The thicker scintillator layer in the CsI devices typically provides better absorption of the incident X-rays, and thus better imaging efficiency.

### 16.5.2 Fill Factor

Lateral resolution of a 2D digital detector array is determined by the packing density of the individual sensor elements (pixels). The denser the better.

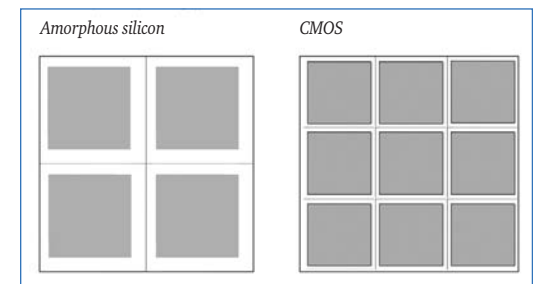

Fig. 14-16. Fill Factor for amorphous silicon and CMOS

This packing density is known as the “Fill Factor” and is illustrated in figure 14-16. This factor is dependent on the minimum possible spacing between individual elements. The Fill Factor can be a reason to select a CMOS type detector for a particular application. For CMOS this factor (active portion) is up to 90%, for amorphous materials up to 80%.



### 16.5.3 Flat panel and flat bed detector systems

There are different types, sizes and suppliers of true 2D flat panel detectors. A variety of flat panel systems exists with a wide range of pixel sizes and resolutions. More and smaller pixels and a high Fill Factor increase the resolution of a panel.

As an indirect sensor material amorphous silicon is in wide use. As direct sensors CCD's (Charge Coupled Devices) and CMOS (Complementary Metal Oxide Semiconductors) are also applied. So far they have limited dimensions. To mimic a large flat panel detector, fast moving CMOS linear arrays are also in use providing an almost similar solution.

#### Amorphous silicon flat panels

For industrial DR, flat panel detectors (known as DDA's: Digital Detector Arrays) in a variety of sizes are used, up to approximately 400 x 400 mm (maximum in 2008) as shown in figure 15-16. These detectors convert incident radiation intensity into proportional and digitised electronic signals. These digital signals can, by means of a computer and screen (workstation), without intermediate steps, be presented as a coherent radiographic image. A cable typically links the detector to the workstation from which the panel is controlled as well.

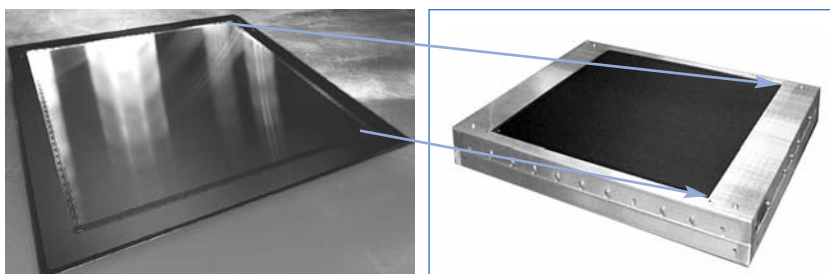

Fig. 15-16. DR flat panel component with 400 x 400 mm active area.

Assembled flat panel detector  
Physical data: Dimensions: ~500 x 600 x 100 mm  
Weight: ~ 10 kg

The most common high resolution two-step flat panels, as illustrated in figure 15-16, use amorphous silicon technology. First a scintillator made of structured Caesium Iodide (CsI) converts incident radiation directly and instantly into light. The conversion is proportional to the radiation dose. Secondly light is converted into a proportional electric signal by thin film transistors (TFT's).

Each pixel contributes to the radiographic image formed on the screen of the workstation. Each element is square in effective area, with pixel pitch typically ranging from 50 to 400 microns. The smaller the pixels the better the resolution, but the poorer the imaging efficiency. Figure 11-16 illustrates this two-step process. Research and development is in progress to make sensor elements/pixels smaller. Depending on overall active area and detector pixel pitch, a panel consists of up to several millions of such elements/pixels.

#### CMOS detectors and flat bed scanners

For some applications CMOS detectors are an alternative for temperature controlled amorphous materials. CMOS has a lower energy consumption and the effect of temperature is less than for amorphous silicon. This in industry is an important feature because it requires less frequent recalibration for systems using CMOS detectors versus unregulated amorphous silicon devices. For amorphous materials with every 5°C to 10°C of temperature variation a recalibration is recommended. CMOS has a wider tolerance of up to 40°C. With CMOS there is no risk of saturation causing blooming and edge burn-out. In addition they show no ghost/memory effect, thus no latent images.

Another fact is that the Fill Factor (active portion of the detector) of CMOS is better than amorphous silicon, see figure 14-16.

Similar to amorphous silicon, CMOS is suitable for an energy range from 20 kV to several MeV, CMOS even to 15 MeV.



Fig. 16-16. Flat bed LDA scanner/panel (courtesy Envision)

So far no true large flat panels using CMOS detectors exist, the maximum size known at present measures 100 x 100 mm with very small pixel sizes of approximately 50 microns, and 200 x 300 mm with pixel sizes of 100 microns. To nevertheless make use of the technical advantages a clever design provides the solution to mimic a large flat panel. Figure 16-16 shows such a virtual "panel" detector, in fact it is a flat bed scanner in which a fast moving linear detector array (LDA) is applied. Such "panels" exist in many formats, up to 600 x 1200 mm, and can even be custom made.

For linear arrays smaller pixel sizes of 50 microns exist, this size can technically be reduced further. Probably negative side effects (cross-talk and noise) would then eliminate the advantages of such smaller pixels.

#### Limitations

In practice DR flat panel detectors have proven to be excellent tools for the NDT-industry, however some limitations apply as well:

- Both true DR and flat bed CMOS scanners have a restricted lifetime caused by the accumulated radiation. Flat panel detectors can be used continuously for years in mass production processes. The ultimate lifetime is determined by a combination of total dose, the dose rate and radiation energy. Flat panel detectors are less tolerant for high than for low energy radiation, hence extremely high energies should be avoided.



- With millions of pixels it is “normal” that over time a few pixels become less responsive, similar to pixels of flat panel displays as used with (notebook) computers. Usually the un-acceptable number and pattern of dead pixels is specified by the manufacturer. Fortunately, in cases a small area of the panel is out of order, an experienced interpreter of DR images is able to differentiate (by pattern recognition and known position on the panel) real component defects from less responsive pixels. Also "interpolation" software is used to reduce or eliminate the effect of bad pixels. So, when a small portion of the pixels respond typically, the corresponding pixel values can be interpolated with data from neighbouring pixels. In document ASTM 2597 a number of terms and definitions are given for malfunctioning pixels or pixel clusters.
- Some flat panel DR detectors are also subject to some memory effect, in jargon called “ghosting”. This is due to hysteresis of the scintillation layer after exposure. The image slowly fades away, particularly in case of high energy - and dose levels. This hysteresis causes a certain dead time of the system, from seconds to minutes depending on the application during which the detector cannot immediately be re-used.

## 16.6 Image quality and exposure energy

### 16.6.1 Exposure energy

To achieve the best image quality the maximum X-ray tube voltage or energy of the isotope selected should be as low as possible. This applies for both film and digital radiography. Figure 17-16 shows a graph taken from EN 14784-2 showing the optimum energy versus wall thickness for different materials.

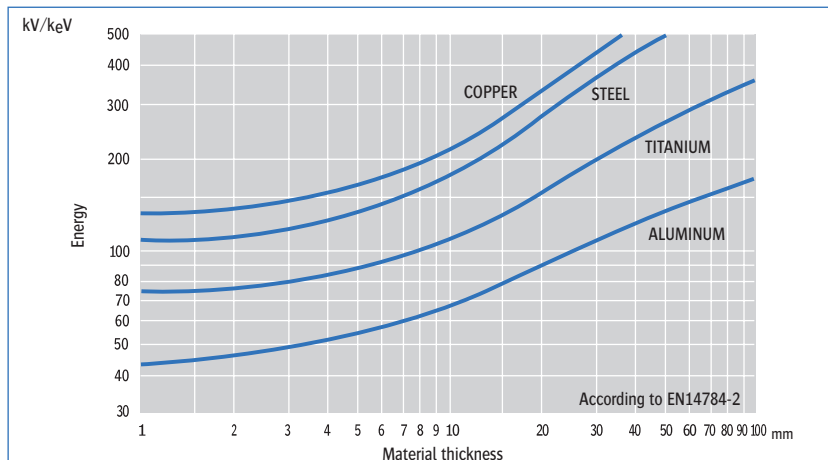

Fig. 17-16. Optimum radiation energies for best image quality

### 16.6.2 Determination of image quality

To determine the quality of a digital image, existing codes require two different IQIs in analogy to radioscopy. One wire- or plaque IQI for contrast, and one duplex wire IQI for the determination of spatial resolution (unsharpness).

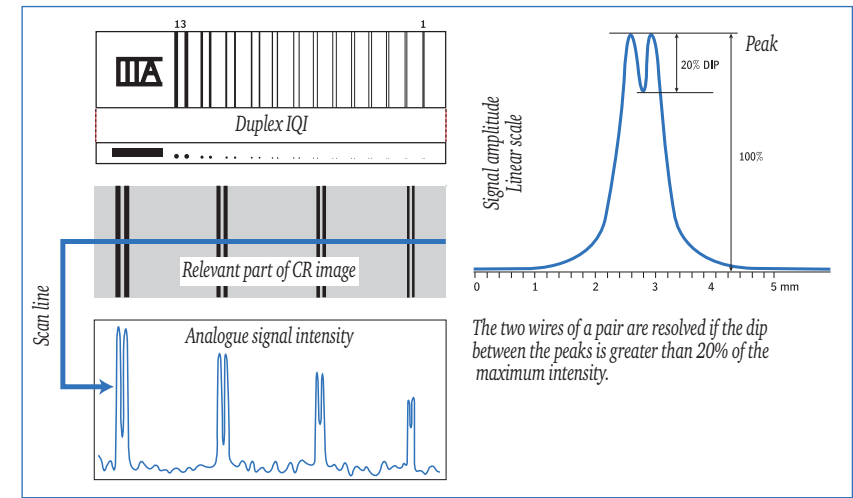

Fig. 18-16. Resolution criterion of duplex IQIs for digital X-ray images

To establish spatial resolution a density line scan across the X-ray image at the location of the duplex IQI should be made to determine this resolution. The resulting linear analogue response of this scan is then interpreted to determine achieved resolution as illustrated in figure 18-16. The criterion is that the dip between two peaks of the wire pair must be equal to or more than 20% of the peak heights.

To avoid line interference or Moiré-effects during the line scan process of the reader, the IQI for that purpose should be rotated for 5° with respect to edge of the CR plate or DR panel, as required by EN 14784-1 and illustrated in figure 19-16.

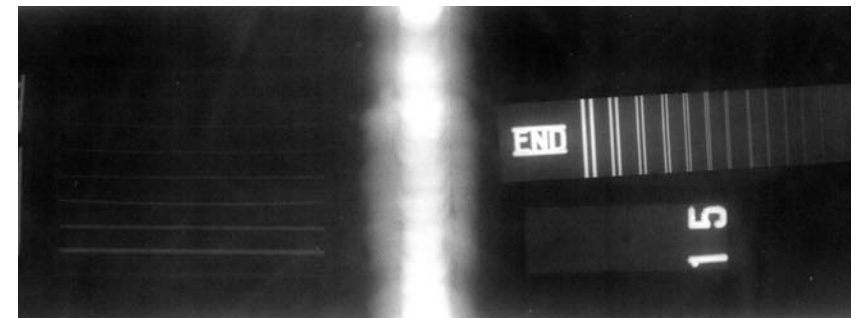

Fig. 19-16. CR image of a weld with rotated duplex IQI

### 16.6.3 Indicators of image quality - MTF and DQE

#### Factors influencing image quality

In the process of making a radiograph three factors influence the ultimate image quality:

1. exposure conditions
2. detector performance/efficiency
3. performance of the processing equipment to form an image

To enable quantification of the quality of digital radiographs and the hardware used to create them, two notions are in use: MTF and DQE.

#### Image quality definitions

Image quality is the total result of resolution/sharpness, contrast resolution and noise. Conventional X-ray films exhibit an extremely high intrinsic resolution due to the fine granularity of the radiation sensitive crystals (a few microns in size). The resolution of the resulting image is far better than the human eye can resolve. Hence for film contrast IQI's provide an adequate measure of indicating resolution and image quality that meets the qualification needs of industry, thus there is no need for any additional resolving criteria for traditional film. However, digital radiography has a much coarser intrinsic resolution (typically 50 microns or more) so a different situation exists compared to film radiography.

To select or purchase the proper digital system, information that quantifies the resolving power of a digital system is needed. Although generic methods to measure optical resolution exist, they have not yet been fully specified for digital radiographic systems.

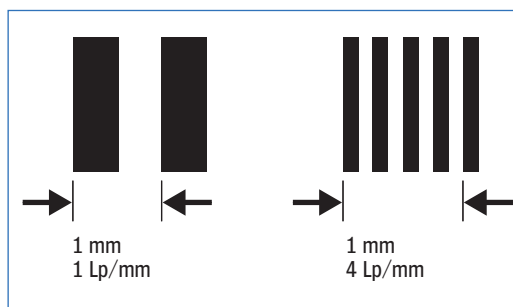

Fig. 20-16. Resolution: line pairs per mm

Resolution is defined as the smallest separation (distance) between two objects that the human eye can distinguish. Because the human eye is not easily quantifiable, an objective method to indicate resolution is needed. Resolution is dependent on contrast (grey levels) and separation (distance).

Resolution is expressed as the number of line pairs (black and white) that can be distinguished in one mm, see figure 20-16.

#### Exposure parameters

The quality of a digital image is affected by a number of factors. The final image cannot be better than the quality of the X-ray information arriving at the detector. Just as with conventional film radiography, this inherent loss of information is determined by a variety of parameters. These are; the X-ray spectrum (kV, filters, and screens), the part to be inspected (thickness, material) and exposure conditions (focal distance, backscatter, exposure time). The overall effect is visible as loss of contrast and sharpness of the final image on the screen of the workstation. Some optimisation is possible for digital systems, the majority of measures quite similar to those appropriate for good conventional film techniques.

#### MTF (Modulation Transfer Function)

No imaging system is perfect. All imaging systems record their inputs imperfectly. One obvious shortcoming - of paramount importance for radiography - is a reduction in sharpness by imperfect contrast transmission throughout the total imaging chain. The scientific method to quantify performance (fidelity) to transfer contrast information is characterised by the "Modulation Transfer Function", MTF for short. MTF describes the relation between contrast and spatial frequency.

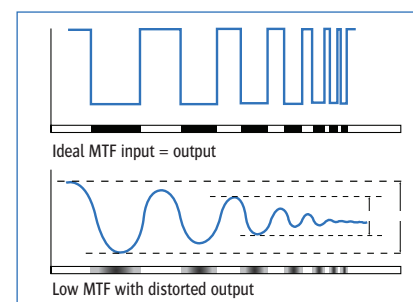

Fig. 21-16. MTF and resulting contrast distortion

In practice MTF characterises the unsharpness (blurriness) that a digital system adds to an image, thus indicating the level of distortion of contrast/sharpness in the resulting image as illustrated in figure 21-16.

The graph shows the distortion of contrast of a square wave (black-white) input and output for an ideal MTF of 1 (100%) and a low MTF. Each step in an imaging chain has an individual MTF.

The MTF of a complete system is the product of the MTF's of the individual steps. In the end of an imaging process the effect is visible in the amount of loss of image quality. MTF for a total system typically ranges from 0 to 1 (0 to 100%). Sharp features and small flaw indications will be more easily visible in images produced with a system that has a high MTF.

Figure 22-16 graphically shows the image distortion of for example an ideal pin-shaped detail that through successive distortions by the steps in the system, is presented as a blurred spot on the screen of the workstation. Every step in the process widens the detail that was ideal in the beginning with a simultaneous reduction of contrast and sharpness.

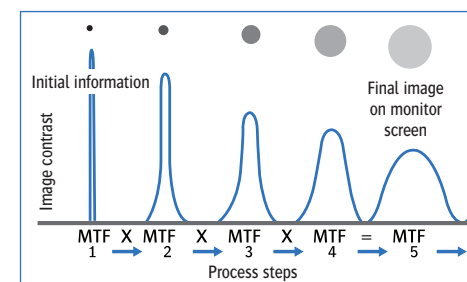

Fig. 22-16. MTF causing step-wise image distortion



### DQE (Defective Quantum Efficiency)

Just as it is more difficult to discern fine detail when an object is dimly lit, it is also more difficult to observe defect indications in a noisy X-ray image with limited detected dose. The effects of contrast and noise on defect recognition is illustrated in figure 23-16.

Thus, in addition to the two factors (exposure parameters and MTF) already mentioned there is an additional loss of image quality if some of the X-rays are not absorbed during the primary detection process determined by the ability of the detector to accurately transfer the information present in the incident X-rays. MTF does not take into account the inherent noise resulting from the X-ray dose available for an image or noise added by the detection system. The measure that combines MTF with detection efficiency and noise considerations is known as “Detective Quantum Efficiency”, or DQE for short.

In mathematical terms DQE can best be thought of as the square of the signal-to-noise ratio ( $SNR_{out}$ ) of the X-ray contrast measured by the detector, divided by the square of the contrast- $SNR_{in}$  incident on the detector, for each spatial frequency:

$$DQE(f) = (SNR_{out})^2 / (SNR_{in})^2 \text{ otherwise: } DQE \approx \text{Image quality} / \text{Dose}$$

So, DQE indicates a detector system's ability to accurately represent all of the contrast information present in the incident X-ray field as a function of spatial frequency. A perfect detector will give a DQE of one (100%) over all frequencies, while a poor detector has a DQE that approaches zero.

For example, assume there are two detectors with different DQE's. If the same incident dose is applied, the detector with the higher DQE will give a larger  $SNR_{out}$  and better image quality. Alternatively, the same image quality can be achieved with the other detector as well, but requiring a higher dose, which translates to increased exposure time or higher tube current. In general, DQE consolidates many individual parameters (resolution, efficiency/exposure time, noise etc.) into a single parameter describing the overall plate- or panel performance. Therefore specifying DQE for a detector will also help determine both the final image quality and inspection times required for a given application. Like MTF, DQE can range from 0.0 to 1.0; numbers in practice vary from 0.05 to 0.9.

**In summary:** MTF quantifies the maximum possible resolution of the total system, but DQE quantifies the actual performance of the detector including its resolution, noise and dose efficiency (exposure efficiency). The DQE function characterises the final image quality versus the inspection time required for a given application.

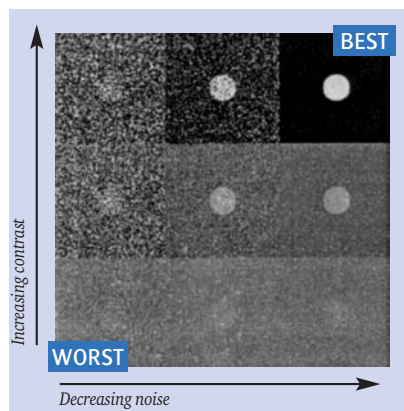

Fig. 23-16. Defect recognition versus contrast and noise

**Remark:** MTF and DQE are used to characterise detectors and systems. Some users may find these scientific notions rather abstract and hard to understand. While very useful in selecting a detector for a particular application, in practice they do not replace the duplex IQI as final indicator of image quality for CR- and DR applications.

### Noise, image averaging and DQE

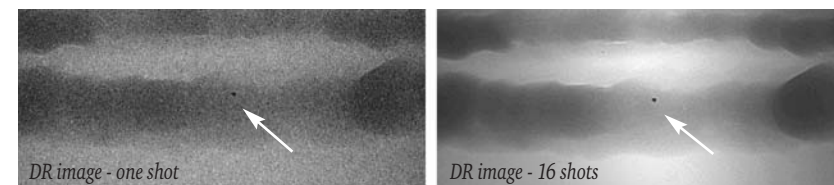

Fig. 24-16. Effect of image-averaging on noise and image quality

Noise is a dominant factor in the DQE value. System noise can be reduced by signal averaging resulting in improved image quality as illustrated by the images of figure 24-16. Noise in turn depends on dose, thus the time needed for an exposure to create an image that might include signal averaging to achieve the required image quality. Reduction of noise by averaging the signals from a number of exposures increases the image quality but reduces the DQE value due to the longer exposure time.

## 16.7 Resolution – number of bits

Resolution is a key word connected with digital radiography. Apart from all digital processing inside the system it is ultimately the image resolution that determines its quality. Two resolutions are of importance:

1. depth resolution – the number of grey levels in which a signal is presented
2. lateral resolution – the pixel size

### Bit depth

For depth resolution, to present the densities in a map like image, usually 12 bit ( $2^{12}$ ) is applied. This corresponds to 4096 different grey levels, which corresponds (when for convenience divided by 1000), to 4 in film technology. The effect of the number of bits is illustrated in figure 25-16. Image A shows a 1 bit ( $2^1$ ) 2 level image and hardly contains any information. Image B shows a 2 bits ( $2^2$ ) image equal to density 4 grey levels with still lots of missing details. Image C shows a 12 bit image, providing more than sufficient information and showing all details even far beyond what the human eye can distinguish.

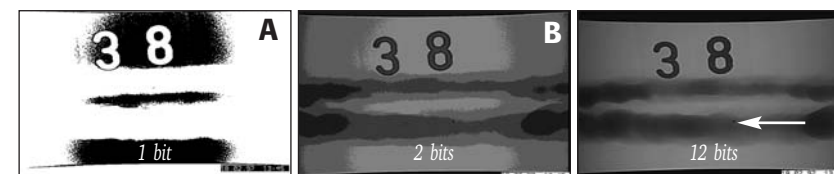

Fig. 25-16. Depth resolution by number of bits



### Lateral resolution

Lateral resolution is determined by pixel size. First of all the pixel size of the detector and secondly the pixel size of the display screen. The effect of pixel size and number of pixels is illustrated in figure 26-16. The same text is displayed in four different resolutions. The text on top shows 6 pixels vertically, step by step increasing to 50 pixels for the lowest text. For this reason also the hardware of work stations is specified by standards to guarantee best possible image presentation without loss of information as contained in the original digital data.



Fig. 26-16. Effect of number of pixels on lateral resolution

Hardware performance should be equal to or better than the required exposure/detector quality.

### 16.8 Comparison of film, CR- and DR methods

The choice of which technique to use depends first of all on the requirements with regard to the ultimate image quality. In both the CR- and DR methods the same IQI's also used in conventional radiography are applied to check the radiographic process and image quality. The major parameters to compare the three methods (film, CR and DR) are speed (dose needed for creating the image) and image quality (noise, resolution, contrast). Figure 27-16 graphically illustrates the relative image quality of different films and digital techniques.

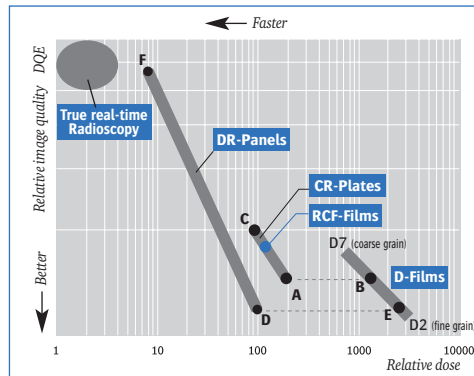

Fig. 27-16. Relative image quality and speed of the various radiographic methods  
This graph appears enlarged in the appendix.

This overview shows that the best image quality (best IQI visibility) of CR plates is similar to what can be achieved with medium to finer grain film (compare point A with B) but is approximately five times faster. At point C the quality is less than what can be achieved with coarse grain film but the speed is more than ten times faster compared to point B. RCF films (five to ten times faster than D7-film) are positioned in the same range as CR plates. The graph for DR panels is based on the results obtained with common flat panel detectors with different numbers of pixels (25 to 400 microns). The best quality that can be achieved with DR panels comes close to fine grain film D3 (compare point D to point E).

The graph also shows that the speed is much higher to achieve the same image quality of D-type films. Depending on the required image quality a time saving of at least a factor 20 (D against E) and roughly 200 (F against E) can be achieved, however with poorer quality. The range for true real-time (real instant) images shows that exposures can be made with extremely low dose but at cost of image quality.

### 16.9 Impact and status of CR- and DR standards

#### Development of standards

The application of established NDT methods is almost exclusively possible thanks to the existence of written standards (codes, norms, guidelines, procedures, specifications, qualification of personnel, etc.). For the introduction and market acceptance of a new non-established NDT method - apart from economic considerations - it is therefore essential that standards support its use. The standards for film radiography were written many years ago and did not envisage digital radiography, so a whole set of new standards is required.

#### Terminology

What's in a name?

- Standard
- Standard practice
- Recommended practice
- Norm
- Code
- Procedure
- Specification
- Qualification
- Guideline etc.

In general the issue of standards lags far behind the introduction of a new method. Development of standards starts earliest once a new NDT method is almost mature and has shown certain market viability. The creation of a standard usually is a time consuming and painstaking formal process. Standards are compiled by (international) working groups consisting of NDT-specialists of different disciplines e.g. research and development, industry, universities and authorities. Participation of authorities at an early stage can speed-up legislation (legislation) and release of a standard.

Sometimes industrial, economic and scientific interests do not fully match and hamper quick release of a new standard. Even under the most favourable conditions, making a standard is a process that takes many years; at first it requires a "working document" followed by a "preliminary version" prior to official release. Until 2005 this was the situation for CR and it still is for DR.

#### Major Issuing Organisations

- ISO
- EN
- ASTM
- ASME
- JIS
- IEC
- DNV

In addition to the many specialists involved, there is also a large number of national and international normalisation organisations that issue such standards. They often adopt the content of each other's documents, to save time, after careful judgment of the content and give them their own specific issue numbers and annotations.





### Status of CR standards

For CR, standard EN 14784 has been issued with EN 444, EN 584-1 and EN 462-5 in mind to achieve conformity with film radiography. Part 1 of EN 14784 describes classification of systems and part 2 describes principles and applications (not including welds). Although a working group for the compilation of an EN standard for welds exists, the issue of such a standard would still take several years.

### Status of DR standards

Application standards for DR do not exist at all, which hampers the strong potentials of this method to be used. A first document (ASTM E 2597-07) related to DR hardware has been issued. It is intended for use by manufacturers of digital detector arrays to quantify the performance of such devices. This is also of importance for those involved in the selection/purchase of systems. This ASTM document includes paragraphs describing the terminology for specification of the condition of pixels (e.g. dead, noisy, over- or under responding, bad clusters, etc.), as well as figures on noise, contrast sensitivity, etc.

### Impact of standards

Despite the lack of a full range of supporting documents CR and DR are in use for lots of applications that do not require international standards. Example are e.g. in manufacturing plants (castings), corrosion detection (profile or on-stream radiography, which is a fast growing market) and a limited amount of weld inspections based on the ASME or DNV standards that allow CR and DR. Certainly CR and DR would already have found more applications if standards would have been available. Regardless of the availability of such documents, if there is a choice, economics will determine which method is selected for a particular application.

In addition to codes, standards, norms etc. (which permit a certain NDT-technique), plant owners often compile specifications, which complement codes and standards with their own requirements. NDT service providers often compile so-called application processes which describe how to apply a technique in a defined application. Such procedures are often part of the formal contract between parties and are essential to achieve uniformity. To speed up the instruction of a new NDT method or technique industry sometimes takes initiatives through JIP's (Joint Industry Projects) to develop procedures or recommended practices, in order to obtain the quality and uniformity of results industry requires. For example HOIS (an international working group with members active in the offshore industry), is working on an improved procedure for the application of CR. Such documents indicate the requirements for NDT-education (level), CR application training and image interpretation.

The results of such efforts are often (partly or in their entirety) implemented in documents issued by international standards-issuing organisations.

### Standards for weld inspection

No EN standards exist (2008) for weld inspection. However, other standards are formulated in such a manner that digital radiography can be an alternative.

For example ISO 3183-2007 permits other means as formulated below:

*E.4.2.1 The homogeneity of weld seams examined by radiographic methods shall be determined by means of X-rays directed through the weld material in order to create a suitable image on a radiographic film or another X-ray imaging system, provided that the required sensitivity is demonstrated.*

Also API 1104 20th edition permits X-ray imaging with other means:

#### 11.1.2.3 Other Imaging Media

*As a minimum, the procedure for radiography using imaging media other than film shall include the following details: (...)*

A similar formulation is included in DNV OS F101:

#### Radioscopic testing:

*Specific requirements to radiography of installation of girth welds.*

*213 Radioscopic testing techniques in accordance with 13068 may be used provided the equipment has been demonstrated, in accordance with Subsection F, to give sensitivity and detection equivalent to conventional X-ray according to ISO 12096.*

Last but not least ASME V (2007) supports the use of the CR technique for weld inspection as well. Although no EN-standard for welds exists until yet, an international working group is involved in its compilation. It is the intention to split existing EN 1435 covering weld inspection into three parts; respectively for film, CR and DR.

For CR, already many years on the market, not even an (EN) "working document" for weld inspection exists, so it will take several more years for it to appear.

### Data exchange and tamper proof standard

Similar to the medical world, where digital radiography has been in use long before its introduction in the NDT industry, standards for data recording have been developed. For industry a standard practice exists (ASTM E 2339-04) to facilitate interoperability (between systems and third parties) of digital NDT data acquisition and imaging.

This document harmonises image file formats. ASTM E 1475-02 regards DICONDE file formats. DICONDE is the acronym for **D**igital **I**maging and **C**ommunication in **N**on **D**estructive **E**valuation. This document includes a tamper proof file protocol to eliminate potential concerns. In any case data is recorded in unprocessed format.

## 16.10 Selection of CR- and DR methods

In radiography, as in other areas of NDT, no one method or technique will serve all situations of need. There are a number of factors to be considered when evaluating a radiographic imaging system beginning with the size, shape and the flexibility of the sensor. Contrast sensitivity or grey scale range (e.g. 8 bit versus 12 bit), and resolution (pixel size) are major factors in determining the imaging performance and scan rate. All these factors must be traded off against size, mobility and cost.

In storage on phosphor based imaging plates for computed radiography, the conversion of radiation into an image is a two-step process. The DR technique, however, immediately (during exposure or within seconds following exposure) produces an image on the screen of the workstation (see figure 33-16). This makes DR extremely useful in automated, robotic, production processes. Although DR, with the correct exposure parameters, offers a higher relative image quality than CR, flat panel detectors are less suitable for field use and for applications with difficult access requirements due to their physical size (thickness) and inflexibility/rigidity. Contrary to DR, CR plates are thin and can be bent to conform with to curvature of the component which sometimes is a condition for certain exposures. Moreover flat panel detectors require a considerably higher capital investment than the CR method.





Although the electronics needed for both methods, e.g. workstation, cost approximately the same (and partly can be shared!), a flat panel detector (~ € 150,000 ) is roughly 200 times more expensive than a phosphor plate (~ € 750 ). Hence selection of a DR solution requires careful considerations with regard to return of investment (pay back period). Another aspect of paramount importance, which influences selection between CR and DR, is the availability (or lack) of industrial standards.

**In summary:** Numerous aspects with a great diversity such as: image quality, process speed, productivity, portability, robustness/fragility, (in)flexibility of plate or panel, available field space, logistics, environmental issues, capital investment, human investment, (non)existence of industrial standards etc. play a role in the ultimate choice between conventional film or CR or DR .

### 16.11 Applications of CR- and DR methods

#### Corrosion detection

For certain applications, e.g. when the requirements for image quality are less stringent and normal or coarse-grain film could be used, the CR technique is an excellent alternative to film. Examples include profile (on-stream) radiography, the majority of the work in 2008 (using isotopes) to detect general internal erosion or corrosion of non-insulated piping, see figure 28-16 and detection of internal and external corrosion under thermal insulation (CUI) see figure 29-16. For wall thickness determination of (insulated) pipes the so-called projection (shadow technique) or tangential technique is applied, see section 18.6.

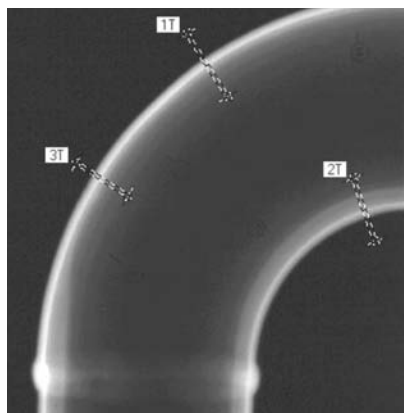

Fig. 28-16. CR image of bare pipe with areas marked for WT measurements

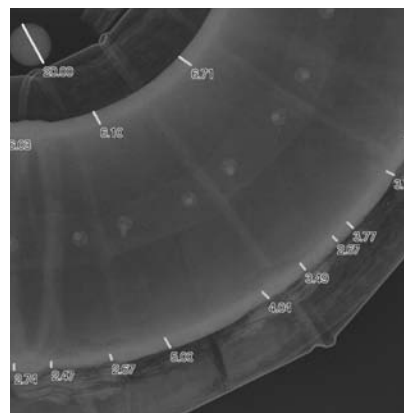

Fig. 29-16. CR image of insulated pipe with WT-values

CR is also very suitable for detection and quantification of erosion/corrosion in or adjacent to the root of welds and for detection and quantification of scaling or clogging, concrete inspection and non-critical castings. In case of offshore work CR is attractive using low activity sources first of all because its smaller controlled area and secondly to avoid that level detectors using radiation are falsely activated or disturbed.

#### Weld inspection

Although conventional film is still superior compared to the CR technique, standards permit CR in several cases because it can under circumstances provide sufficient image quality, even for weld inspection, see section 16.9. Figure 30-16 shows an image of a weld with a clear indication of a serious longitudinal defect.

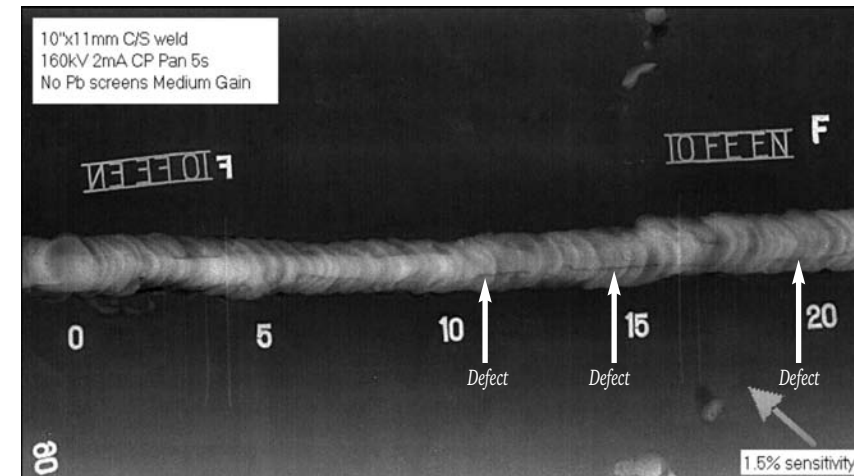

Fig. 30-16. CR image of a weld with a longitudinal defect

see acknowledgements\*

#### Dose reduction and controlled area

Not only are CR- (~ 5x to 10x) and DR techniques (~ 20x with film-quality, to 200x with low quality) much faster than standard X-ray film exposures, (see figure 27-16) another attractive feature is their far greater dynamic range/latitude (> 1000x).

These methods are, therefore, not over-sensitive to variations in radiation dose and very tolerant to less than exact exposure times, see figure 8-16.

This can reduce so-called re-shoots (retakes) and can decrease the need for multiple exposures of some parts with different thicknesses, thus further improving inspection throughput.

The reduced exposure times - in practice a factor 2 to 10 dependent on the type of plate - or weaker sources that can be used, are deciding efficiency- and safety factors (smaller controlled area). The controlled area (radiation exclusion zone) reduces with the square root of source strength ratio:

$$\sqrt{\frac{\text{source strength 1}}{\text{source strength 2}}}$$

**Note:** For a given application the source activity/strength (Bq) can be reduced, but not its energy level (MeV/keV) because it is the energy level that determines the penetration capability.



### Automated/mechanised inspection

The choice of DR flat panel detectors depends on the image quality required and the number of parts to be inspected to make it cost effective (return on investment).

High performance DR detectors are most suitable on stationary locations, for example as part of a production line where vast numbers of precision components are checked at high speed with the lowest possible radiation dose, or in situations where mechanical automation (robotising) can be applied to achieve significant throughput improvements, see figure 31-16.

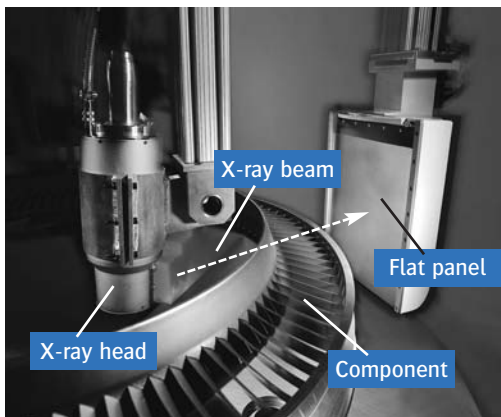

Fig. 31-16. DR inspection of narrow beam weld and turbine blades

### Girth weld inspection

Instant results as provided by DR systems would also very attractive to replace film to inspect the circumferential (girth) welds of long distance pipelines under construction, either on land or at lay barges. Until recently DR systems were more complex and vulnerable than equipment for film radiography, thus not suitable for harsh field conditions. But this has changed.

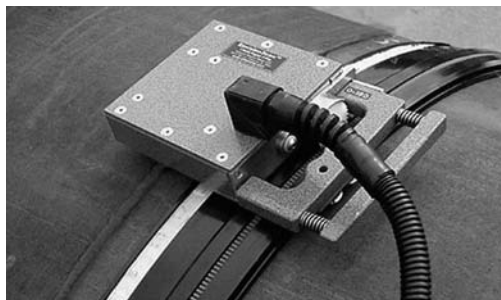

Fig. 32-16. CMOS weld scanner (courtesy Envision USA)

The resolution of DR (although better than CR) is still (2008) too low compared to film to meet the image quality requirements for the majority of such girth welds. Nevertheless, for some type of girth welds, systems using CMOS line detectors with small pixels combined with a high contrast resolution which rapidly orbit around the pipe, could provide a solution. They can scan a weld in a few minutes with a reasonable image- and contrast resolution.

Figure 32-16 shows the scanner of such a system. The radiation source can be located inside the pipe on a crawler (single wall panoramic image) or outside at a 180° shifted position and rotates simultaneously with the line array (double wall image).

Similar scanners exist not using a band wrapped around the pipe but using magnetic wheels instead. For such applications the CMOS line array must have a fast response- and erase time in order to frequently (many times per second) refresh the information. CMOS detectors are able to do that; and are thus fast enough for girth weld inspection in the field.

### Useful life of plate and panel

CR plates (by handling), like DR detectors (by radiation) have a finite useful life which has to be included in an economic evaluation. The working life of flat panel devices can range up to millions of images, dependent on application-specific details, see paragraph 16.5.3. Thus cost-per-image should be considered in any return-on-investment financial analysis. CR plates in flexible cassettes can be used up to one thousand times.

If used in a rigid cassette their life can considerably be prolonged. In the field, care must be taken that rigid cassettes are not too tightly strapped to a curved component (pipe) to prevent permanent bending causing problems with automated readers as shown in figure 4-16. Such readers refuse over-bended cassettes. This may result in undesirable manual handling of the plates causing plate damage and excessive wear.

## 16.12 Work station

### Hardware and software

A computer and extremely high-resolution display screen are recommended for digitised films as well as for displaying and processing the images obtained with CR- and DR techniques. The number of pixels of the display screen should at least match with the digitisation spot- or pixel size of the applied CR plates or DR panels to achieve maximum resolution. Radiographic images contain more information than the human eye can discern. For this purpose workstations, as shown in figure 33-16, are used as an “image-processing centre”. This workstation operates with powerful dedicated proprietary software (e.g. “Rhythm” of GE Inspection Technologies) to manage, process and adjust images.



Fig.33-16. Work station

### Versatility of the software

Images can be adjusted and enhanced in many ways: brightness, contrast, sharpness, noise suppression (averaging), rotation, filtering, inversion, colouring, magnification, zoom-pan-scroll, etc.

In this way, hidden details can be made visible, see figure 34-16.

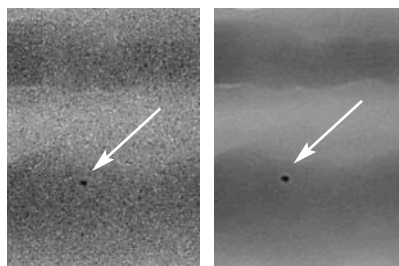

Fig 34-16. Effect of image-averaging on noise

Figure 35-16 graphically shows the effect of two control mechanisms for selecting a part of the density range of the image for a closer look. The Z-shape can be shifted from left to right through the whole range of densities of the image. The angle of the vertical part can be changed to increase the width of the window (steeper or more flat) to alter the range of contrast/densities.

The position of the “working point” determines the brightness of the image. In this graph 16 grey levels on the digital image result in one level on the monitor, this can be set at 1-to-1. These are a few examples of the versatility of the adjustment features provided by the workstation.

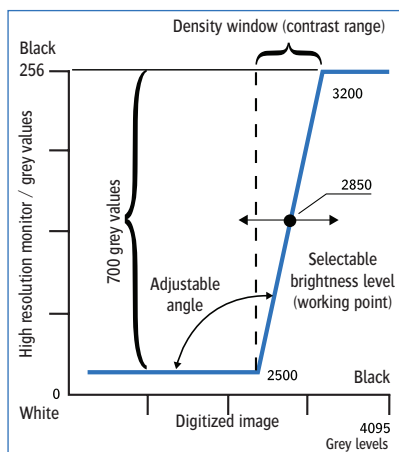
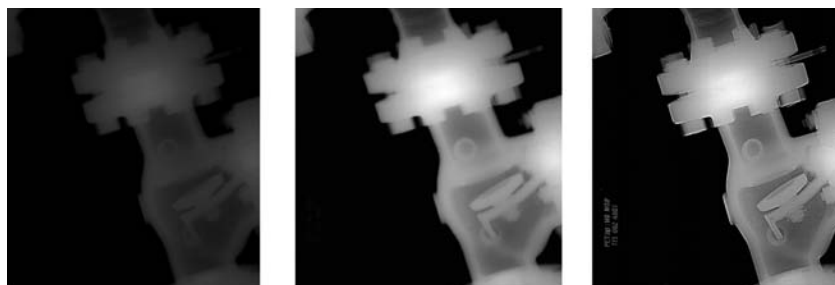

Fig. 35-16. Flexibility of image (grey values) adjustment

Figure 36-16 shows the effect on an image by contrast enhancement and sharpening. Here the contrast improvement, flat Z-shape (wide density window), makes the interior of a valve clearly visible compared to the initial image. It proves that the information is present in the initial image but has to be adjusted to make it visible for the human eye.



Original image  
Contrast improvement  
Sharpness improvement  
Fig. 36-16. Image enhancement in two steps

In addition algorithms have been developed for e.g. the comparison of parts of an image with conformance criteria, carrying out dimensional checks (sizing), for instance to measure remaining wall thickness (see figure 37-16).

For this latter function algorithms exist that takes the source-to-object distance and the nominal pipe diameter as a reference to calculate remaining wall thickness or metal loss due to corrosion. Also defect area measurement, image statistics and a reporting module are part of the tools of the work station.

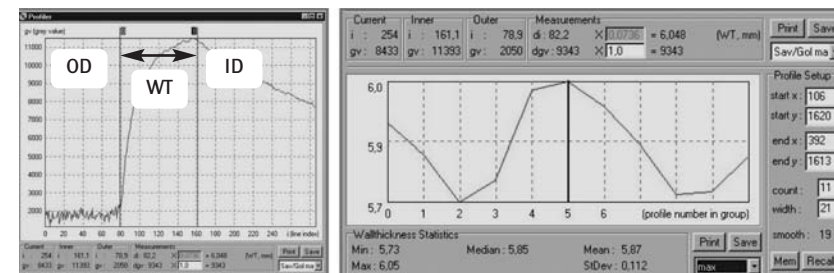

Fig. 37-16. Wall thickness profile from on-stream image of figure 28-16 and report with statistics of all WT measurements

In cases of stationary DR systems in use for large production quantities so-called "Assisted or Automated Defect Recognition" (ADR) programs (software algorithms) can be applied with no human interference to speed up uniform interpretation of images.

Apart from the original image and its imprinted exposure parameters, on a true copy comments and display characteristics (e.g., zoom, contrast, filters) can be superimposed and archived as well. This enables inspection professionals to streamline the process and improve the quality of distributed inspection information.

Figure 38-16 shows a screen shot made of the workstations display. The screen shows the results of an on-stream exposure on a CR plate taken of a valve with connecting pipe.

The screen shot includes one of the selectable frames of the report module.

The image itself shows marks (white lines) super-imposed by the workstation's operator to establish the remaining wall thickness at those places to be calculated by the software.

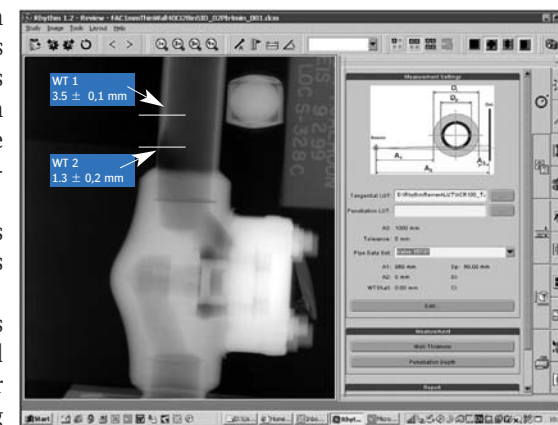

Fig. 38-16. On-stream image and report of a valve





Wall Thickness Result				
Nr.	Material	D <sub>A</sub>	WD <sub>Soll</sub>	WD <sub>Ist</sub>
1	Steel		3,5	3,5
2			3,5	1,3

Figure 39-16 shows a detail of the selected pipe wall area with the reported results.

This example of a valve with a great variety of wall thicknesses also shows one of the strengths of a digital exposure. If needed the same image can be used to study the thin and thick wall parts of the valve thanks to the large dynamic range contained in the image.

Fig. 39-16. Detail of pipe wall of figure 38-16 with report

**Archiving and reliability of images**

Archiving can be done on almost all existing professional mass storage facilities, e.g. CD-ROM (~700 MB), double layer DVD (~10 GB), double layer HD-DVD (~30 GB), double layer blu (blue) ray disk (~50 GB) or hard disk.

In the not too distant future other high capacity optical solutions such as holographic disk technology (~300 GB) will become available.

Such mass memories are needed to be able to store a number of high resolution digital images A single image of a ~ 400 x 400 mm panel with a pixel size of 50 microns requires 120 Mb (position and up to 16 bit of density data). A pixel size of 100 micron needs “only” 30 MB.

Integrity-procedures should be applied to prohibit manipulation or even forgery of digital images. To exclude such tampering with images, it is part of the data handling protocol to always include the original unprocessed data with the processed data set (images), see section 16.9.

Although attractive to save memory space, it is impossible to compress the original unprocessed data. However, for reporting purposes, algorithms such as JPEG, are in use to reduce file sizes of processed images and for printing .

**Exchange of data**

The workstation can also transfer images electronically over great distances (through internet, intranet or wireless), which can be viewed, interpreted or stored by remote users on identical satellite workstations.

This way information is sent to the experts rather than sending the experts to the information. Because the images are digital, multiple copies of the images are always identical. These capabilities are driving the latest trends of enhanced database capabilities and common workstation standards for digital radiography software.

Figure 40-16 shows a block diagram of the various components that make up a complete system for digital radiography.

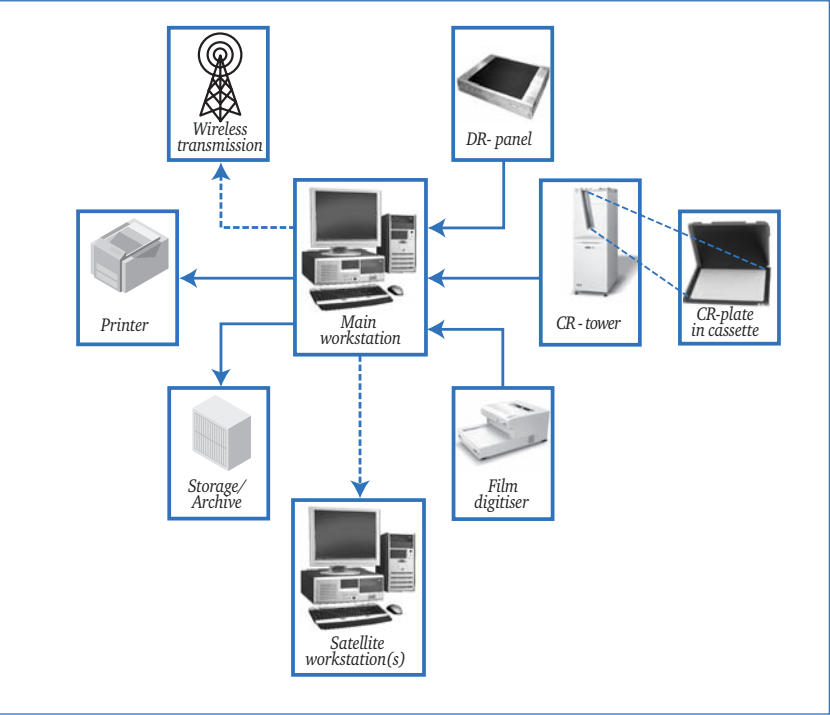

Fig. 40-16. Block diagram for digital radiography with workstation and supporting equipment



# 17 Special radiographic techniques

The previous chapter (16) dealt with techniques that would be impossible without the aid of computers. These techniques share a common feature, whereby the processing, interpretation and storage of data is done by a central computer and monitor, also called the workstation. In the current chapter (17) computers also play an everincreasing important role in some of the techniques discussed. Computer tomography (CT) and the Compton backscatter technique for example would not exist without them.

## 17.1 Image magnification techniques

### 17.1.1 Common image magnification technique

By positioning an object between an X-ray tube and film or detector, as illustrated in figure 1-17, a magnified image is obtained. As a consequence any defect will be magnified as well. The sharpness of the image is dependent of focal spot size, the smaller the spot size the better the sharpness.

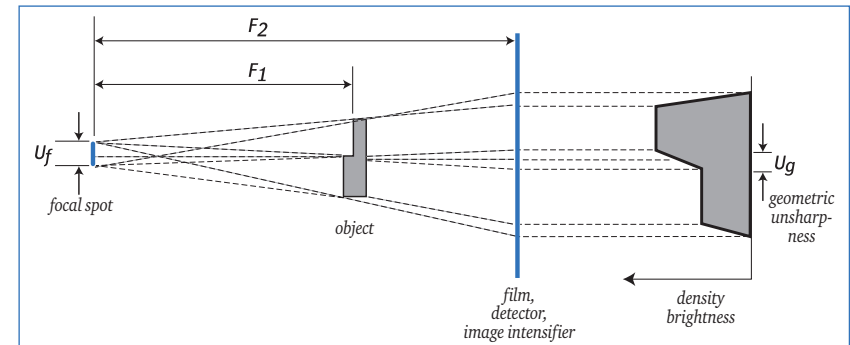

Fig. 1-17. Image magnification

Any unsharpness, as illustrated in figure 1-17, is determined by the relationship between  $F_1$  and  $F_2$ , and the size of  $U_f$ .

The effective unsharpness is calculated as follows:  $U_g = U_f (F_2 - F_1) / F_1$

**For example:** An X-ray tube with a focal spot size of 20 microns with focus-to-object distance ( $F_1$ ) of 50 mm and focus-to-film distance ( $F_2$ ) of 550 mm will have a geometric unsharpness of:  $0.02 (550 - 50) : 50 = 0.20$  mm

The magnification factor is:  $F_2 : F_1 = 550 : 50 = 11$

The magnification technique is mainly used in combination with a radiation-sensitive device such as fluorescent screen, image intensifier or flat panel detector. A computer workstation may be used for image processing and/or enhancement prior to interpretation on the screen.





## 17.1.2 High resolution X-ray microscopy

### Magnification factors

For a number of years magnification factors up to 25 were sufficient. The maximum magnification factor was determined by the smallest possible focal spot size. As illustrated in figure 1-17 larger magnification factors create unsharp images without providing more information. Moreover the intensity of the output is limited by the heat dissipation of the target anode. For some time this was a physical barrier. With the introduction of microfocus and more recently nanofocus X-ray tubes, new techniques have been developed for inspection of low absorbing objects like electronics, applying large magnification factors with still high resolution.

Because of the need to inspect parts with ever decreasing dimensions, such as electronic components and their joints or other products with extreme quality requirements and product process control, ever growing image magnification factors were necessary, ending up in so called "X-ray microscopy".

The need for geometric magnification factors of up to 2,000 are no exception. This was the incentive to develop X-ray tubes with extreme small spot sizes. Because there is a physical limit to the minimum focal spot size (limited heat dissipation and output) other measures (tricks) can be taken: a combination of software, lenses and cameras to further zoom in, even up to 25,000. It should be realised that magnification only make sense if the initial image quality is sufficient, a poor image just creates bigger pixels or results in a vague image.

### Microfocus and nanofocus X-ray tubes

Over the years industry developed X-ray systems with ever decreasing focal spot sizes to meet the need for large magnification factors. At present focal spot sizes expressed in a few hundreds of nanometres (nm) are on the market.

By conformation, manufacturers of X-ray tubes classify their tubes dependent on focus size in a few categories:

- macrofocus with spot sizes > 100 microns (0.1 mm)
- microfocus with spot sizes ranging from 1 micron up to 10 microns
- nanofocus with spot sizes far below 1 micron.  
Sizes of down to 0.25 micron (250 nm) do exist.  
The Nanofocus\*\* (see acknowledgements in chapter 20) X-ray system is just one example of such a system.

The output of nanofocus X-ray tubes is proportionally lower than for tubes with larger focal spot sizes. Heat dissipation of the target anode generating the X-ray beam puts a limit to the output. The smaller the target the lower its output. Over-heating destroys the anode by burn-in.

Two types of X-ray tubes exist:

- The closed X-ray tube, a sealed evacuated glass tube containing all components to generate X-rays. No part in it can be replaced or repaired
- The open X-ray tube with a removable/replaceable anode/target and filament with its own high vacuum system for an almost unlimited life.

A closed system is cheaper and maintenance-free, but has a shorter life time than an open tube. An open tube, with an almost unlimited life-time, can operate at higher voltages and currents. Replacement of target or filament once damaged requires less than half an hour; a very acceptable down-time.

Using micro- or nanofocus X-ray tubes has the following advantages:

- Very small defects are discernible
- Low backscatter because a small part of the object is being irradiated
- High resolution.

Disadvantages are:

- Costly if (separate) high-vacuum equipment is required
- Time-consuming, as for each high resolution exposure only a small part of the object is being irradiated.

### Tube heads

There are two types of tube heads for small focus X-ray tubes.

Figure 2-17 illustrates the two types.

The transmission tube provides the highest magnification (smallest focus).

The directional tube, as common in standard X-ray tubes, provides the highest energy.

This figure also shows the magnetic lenses that create the essential focussing of the electron beam.

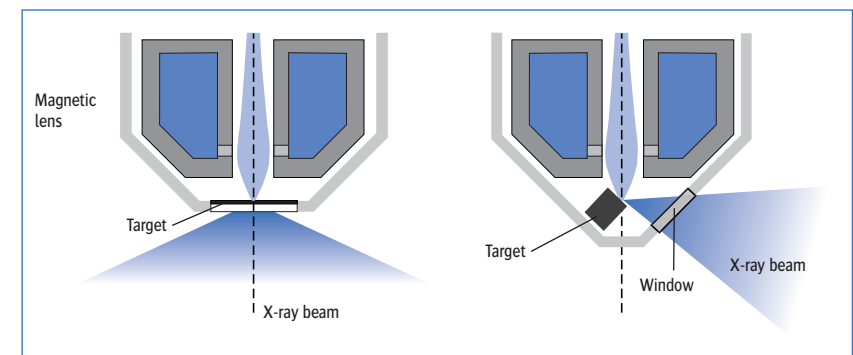

Fig. 2-17. Transmission- and directional small focus tube heads



### System set-up

Figure 3-17 shows the concept of a two-dimensional (2D) X-ray microscopy system to inspect small components consisting of a micro- or nanofocus X-ray tube, an X-Y-Z manipulator and detector. The manipulator can be joystick- or CNC-controlled. Full automation is possible. The geometric magnification can be controlled by the Z-axis. Closer to the tube results in a larger magnification factor.

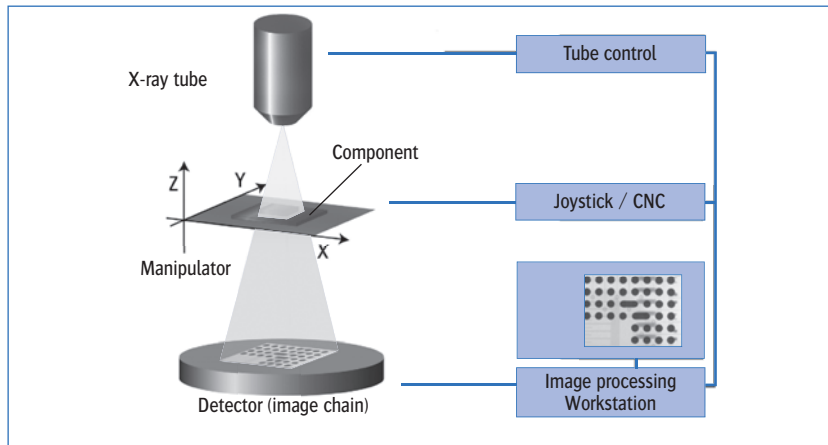

Fig. 3-17. System set-up for X-ray microscopy

The set-up of figure 3-17 is used for flat components. For certain applications, dependent on the geometry of the component, the so called “ovhm” technique (oblique view at highest magnification) is in use.

In such cases an open transmission X-ray tube generates an adjustable oblique (angled) beam, the detector is angled accordingly as illustrated in figure 4-17. Instead of tilting the sample, which would result in a certain distance D that would limit the magnification factor, the beam is tilted as illustrated reducing D to almost zero.

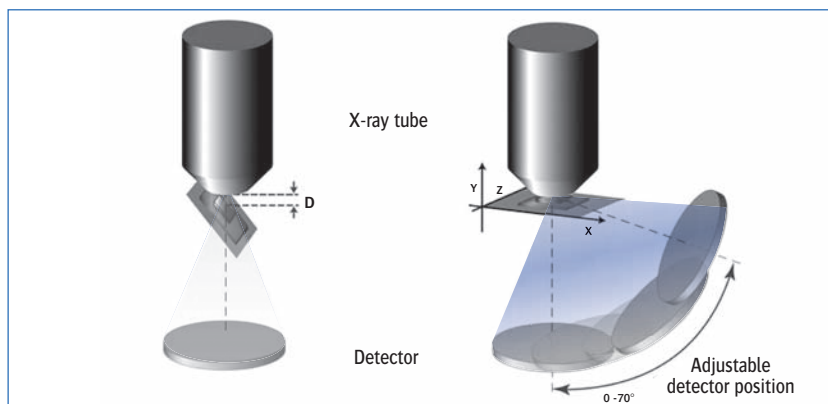

Fig. 4-17. Oblique (ovhm) technique for maximum magnification.

### Effect of focal dimensions

Figure 1-17 illustrates in one way the effect of focal spot size (unsharpness), figure 5-17 shows the same in another way for a micro- and nanofocus tube head.

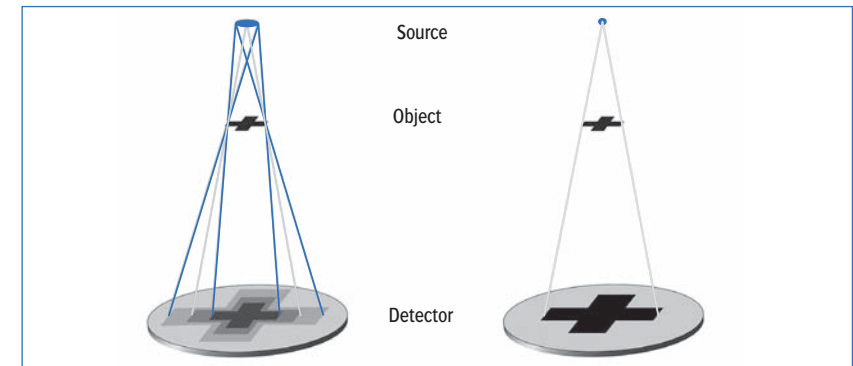
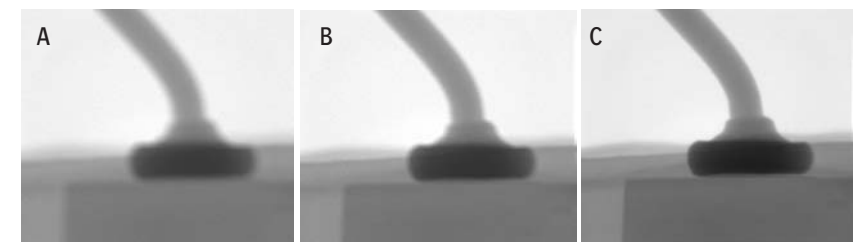

Fig. 5-17. Effect of focal spot size on sharpness

Figure 6-17 shows the effect of focus size on images of a connection (wire diameter 25 micron) in an electronic package. Image A is taken with a focal spot size of 10 micron, image B shows the result for a 5 micron focus and image C was taken with a focus of less than 1 micron. Details of approximately 250 nm are visible.



Focal spot : 10 microns 5 microns <1 micron

Fig. 6-17. Effect of spot sizes on image sharpness for different focal spot sizes

There are rules-of-thumb to determine resolution and potential defect detectability as a function of focal spot size.

For large magnifications, exceeding 100x, the following applies:

- resolution equals the focal spot size divided by two
- detectability or feature recognition equals focal spot size divided by three



### Imaging systems for high resolution radiography

High-resolution X-ray inspection systems usually apply an image intensifier for presentation of results as shown in figure 7-17. This electro-optical device amplifies and converts the invisible X-ray shadow to visible light by means of a scintillation crystal and photo cathode. Electrons from the photo cathode are then accelerated and focused onto a phosphor screen where a bright and visible image is produced that is digitised by a CCD camera. In order to avoid unnecessary losses of resolution, it is crucial to at least use 2 mega pixel high-resolution cameras. To meet highest demands, 4 mega pixel cameras are the best choice.

The advantage of the image intensifier-based digital image chain is its relatively low cost and relatively sharp real-time image.

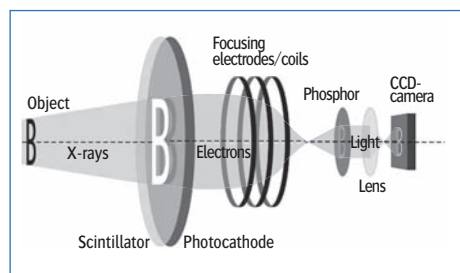

Figure 7-17. Schematic setup of an image-intensifier digital image chain

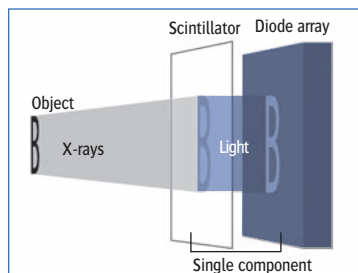

Fig. 8-17. Arrangement of a flat panel based image system

As an alternative, a digital flat panel detector as shown in figure 8-17 can be used. In that case the X-ray shadow image is still converted by a scintillator foil to visible light, which is then directly detected by the photo diode array. This option is more expensive than the traditional image intensifier of figure 7-17.

Digital flat panel detectors provide better images with far superior contrast resolutions of 0.5% compared to 2% of image-intensifiers. This can be a decisive factor for low contrast objects and for high quality computed tomography (CT), see section 17.3.

### 17.2 Fluoroscopy, real-time image intensifiers

Fluoroscopy, also known as radioscopy, is a technique whereby “real-time” detection of defects is achieved by the use of specialised fluorescent screen technology.

At present, there are many alternatives to photographic film for making an X-ray image visible. In addition to the CR- and DR techniques described in chapter 16, a wide range of real-time image forming techniques using display monitors are available.

It can generally be said that the image quality of conventional X-ray film is superior to either true digital (direct) radiography (DR) or computer-aided radiography (CR).

Therefore these new techniques cannot be considered acceptable alternatives at all times. However, when the installation is adjusted to optimal refinement for a single application, for example weld inspection in a pipe mill, a filmequivalent image quality can be obtained, which would only just comply with the requirements. This would possibly require the use of a microfocus tube, see section 5.1.

### Stationary real-time installations

Display monitor systems, as illustrated in figure 9-17, are almost exclusively used in stationary set-ups for production line testing of varying types of objects, in particular in metal casting plants, pipe mills and component assembly industries. Often they provide some image magnification and software features to improve defect detectability.

Sometimes real-time systems are utilised in the food industry to check for instance for the presence of glass fragments or other foreign objects. Being part of a production line and due to the necessary radiation safety provisions (such as cabins) these systems can be very expensive. The display monitors are located at a safe distance.

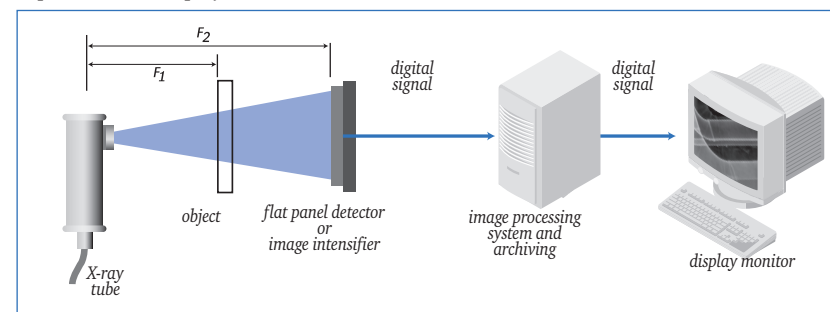

Fig. 9-17. Radiography with image magnification

The choice of a radiographic system to be used for a specific application depends on a number of factors:

- Hardness of the radiation required and appropriate detector
- Resolution or detail discernibility required. The type of defects to be detected in mass-production is normally known
- Magnification factor required when it concerns small defects
- Image dynamics (density range) with regard to object thickness range
- Image contrast required facilitating ease of defect detection. Sometimes this can be “automated” when it concerns common defects
- Time restraints, number of objects to be examined per unit of time
- Budget
- Space available
- Installation and specimen dimensions
- Sufficient safety measures

A number of these factors also influence the choice of detector system.

Some of the options are:

- Phosphorescent screen (afterglow) with TV camera and display monitor (CCTV) at a remote (safe) location
- Fluorescent screen (instant image) with CCTV-system at a safe location
- X-ray image intensifier with conversion screen, in combination with a CCTV-system



- CCD-camera as a substitute for the relatively slow conversion screen
- Photo array detector, minimal size per diode (pixel) approx. 100 microns to inspect slowly moving objects (airport luggage checks)
- Flat panel detector consisting of millions of light-sensitive pixels.

Although the image intensifier is still most commonly used, the flat panel detector is becoming more and more attractive. Flat panel detectors provide various pixel sizes with extensive image dynamics (a very wide density range, far greater than is possible with film). Since the signals received by the computer are digital, the screen image can be optimised for interpretation (contrast, brightness, sharpness, magnification, filtering, noise suppression) and subsequently stored.

These advanced systems also offer the possibility of comparing the image obtained with a reference image and of automatic defect interpretation, see chapter 16. Selection of the most suitable (expensive) system is made even more difficult because of the rapid development in sensor- and electronic technology.

Fluoroscopy, image intensifiers and magnifiers are more elaborately described in the booklets: “Die Röntgenprüfung” and its translation “The X-ray Inspection” [3].

#### Portable real-time equipment

A portable version of real-time equipment is used to detect external corrosion under thermal insulation. It is generally very difficult to detect corrosion on piping with insulation still in place whereas removing and re-installing the insulation is a costly and time consuming operation. Sometimes the likely presence of corrosion is indicated by moisture/water detected in the insulation, see section 17.4.

External corrosion in a low-alloy steel pipe becomes apparent by local swelling of the pipe surface as a result of volume increase of the corrosion layer.

Figure 10-17 illustrates a system by which the swelling and even severe pitting can be detected. On one side a strongly collimated source or X-ray tube is located that must be aligned in a way as to direct a narrow beam of radiation along the tangent of the pipe towards a small flat panel detector behind.

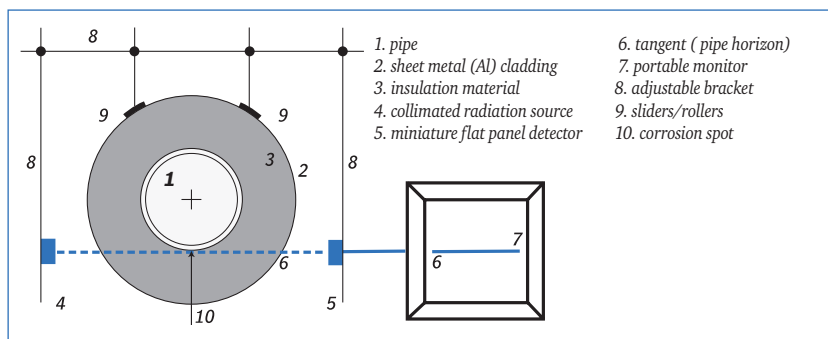

Fig. 10-17. Schematic arrangement of a portable real-time radiographic corrosion detector

This way an image is obtained of the pipe “horizon” with possible presence of corrosion (swelling or pitting). The image is presented real-time on a portable monitor. The battery-powered equipment uses soft radiation of low intensity, so that it can manually be moved along the pipe. The system can also be used to locate welds under insulation, providing the weld crown has not been removed.

### 17.3 Computer Tomography (CT)

#### Unique features

For medical diagnostic purposes, techniques have been developed to obtain a radiographic quasi 3D picture, a so called CT-image with a high resolution of a few tenths of a mm. Powerful computers are used to transform a large number of absorption variations that occur when irradiating a human body with a moving source around the stationary patient, and their coordinates into a comprehensive 3D (volumetric) image. This technique is now also used in industry, e.g. for checking the integrity of components with complex geometries, high quality castings, miniature electronic circuits as built into mobile telephones and even for 3D metrology: a method to measure even internal (inaccessible) dimensions of components that otherwise cannot be measured at all. CT systems with a resolution of only a few microns for a wide variation of tasks have already been successfully applied. To interpret the results, CT images can be freely rotated and virtually sliced in all directions for different views of a defect or other anomaly; a unique and very useful feature.

#### Computing capacity and scanning time

In NDT contrary to medical applications, it is usually the object that rotates between the source and the detector as shown in figure 11-17. This can be done continuously or stepwise to obtain a great number of 2D images that ultimately are reconstructed into a 3D CT image.

The object is scanned section by section with increments of say 1° over 360° with a very narrow beam of radiation (small focus X-ray or collimated gamma-ray). The more increments, the better the CT quality. The receiver in this illustration is a flat panel detector.

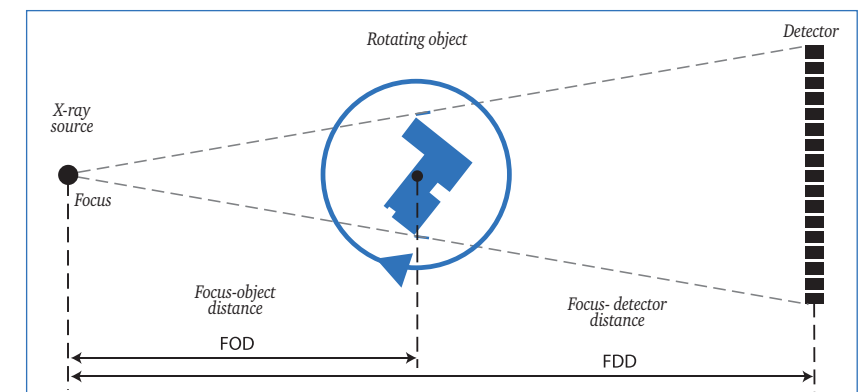

Fig. 11-17. Rotating component to create a 3D CT image



Each individual detector element measures, during a short exposure period, the total absorption across a certain angular position of the object. This information including the coordinates is used to create a numerical reconstruction of the volumetric data.

This process produces a huge data stream to be stored and simultaneously processed, in particular when an image of high resolution is required. A three dimensional representation (3D CT) of the radiographic image requires vast computing capacity. With present day computers, depending on resolution required, the total acquisition and reconstruction time needed for a 3D image is between a few seconds and 20 minutes.

### Reverse engineering

CT offers an effective method of mapping the internal structure of components in three dimensions. With this technique, any internal anomaly, often a defect, that results in a difference of density can be visualized and the image interpreted. These properties allow the use of CT as an NDT tool, permitting examination of samples for internal porosity, cracks, (de)laminations, inclusions and mechanical fit. It shows the exact location of the anomaly in the sample providing information on size, volume and density. Due to the fact that CT images are rich in contrast even small defects become detectable.

CT widely expands the spectrum of X-ray detectable defects in process control and failure analysis, increasing reliability and safety of components for, e.g., automotive, electronics, aerospace, and military applications. It opens a new dimension for quality assurance and can even partially replace destructive methods like cross-sectioning: saving costs and time. CT is increasingly used as a reverse engineering tool to optimise products and for failure analysis which otherwise would require destructive examination.

### CT metrology

CT systems can also be used for so-called 3D metrology. CT metrology systems replace conventional physical or optical measuring devices for components with complex geometries or measure dimensions at places with no access at all. These systems include the software to transfer the part to be measured visible on the CT image into actual dimensions with accuracies of  $\pm 1$  micron.

### High resolution and defect sizing

In CT, absorption values are determined with a very high degree of accuracy, which means that the contrast of an image can be varied over an extraordinarily wide range. Absorption/density variations of 0.02 % can be displayed in a range of density 6 and over. This offers great possibilities for image processing.

For the most challenging X-ray inspections the best results are obtained by high resolution CT using microfocus or nanofocus X-ray sources. The achievable resolution or image sharpness is primarily influenced by the focal-spot size of the X-ray tube.

Defect detectability down to 250 nm (0.25 microns) is possible.

Increasingly, 3D CT is used on high-quality castings often in combination with automatic object and defect identification.

Sometimes the magnification factor is not sufficient. In that case the factor can be increased by scanning only the region of interest. To achieve maximum magnification, the region of interest should be within the X-ray beam (cone) as illustrated in figure 12-17.

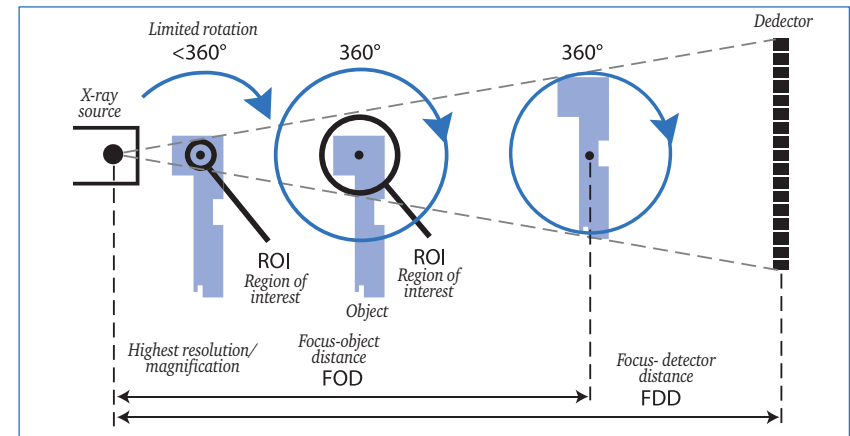

Fig. 12-17. CT scan of object detail

If too close to the X-ray source the geometry of the object can hamper full rotation as illustrated in this figure.

The subject of CT is more elaborately described in the booklets (German) “Die Röntgenprüfung” and (English) “The X-ray Inspection”, see literature reference[3].

## 17.4 CT for defect detection and sizing

### Effect of defect orientation

Traditional radiography almost exclusively uses one single exposure from a fix position, thus one direction of the X-ray beam. This can result in distortion of the defect image on the film, see section 12.1, or even missing a defect. This single shot practice also applies for weld inspection. Welds and their adjacent heat affected zones might contain planar (2D) defects, possibly unfavourably oriented for detection. The probability of detection (POD) of planar defects is strongly dependent on the angle  $\varnothing$  of the beam (radiation angle) and the orientation of the defect, as shown in figure 13-17.

Only transmission under an angle equal to or close to the orientation of the 2D defect will provide sufficient contrast. Figure 14-17 illustrates this.

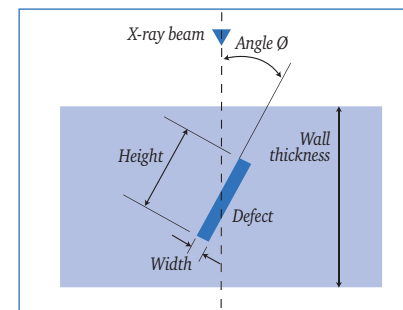

Fig. 13-17. Effect of position of X-ray source versus defect orientation

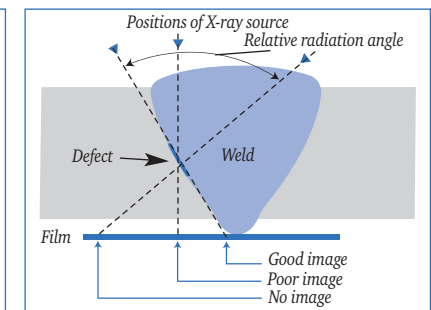

Fig. 14-17. Image formation versus relative radiation angle





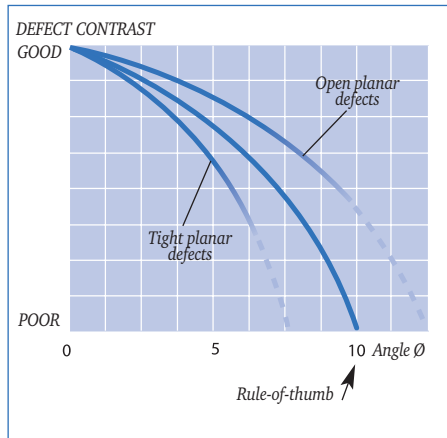

Fig. 15-17. Graphical presentation of "rule-of-thumb"

In practice the following rule of thumb is applied to the detection of planar defects-with a high probability:

*"a defect is detectable if the angle between the X-ray beam and the defect is approximately  $10^\circ$  or less".*

The value of  $10^\circ$  is based on decades of practical experience but does not guarantee detection. The rule is visualised in the graph of figure 15-17. To detect 2D defects with unknown orientations and exceeding  $10^\circ$ , a multi-angle technique would be required, which in general is impractical. As a measure to enhance detection of lack of fusion defects in critical welds, sometimes two

additional shots are made in the direction of the weld preparation. Apart from orientation, the detectability of 2D defects is also dependent on the type of defect, its height and its opening (width). Lack of side wall fusion (LOF) - dependent on the welding method - will in general be easier to detect than a crack because LOF is often accompanied by small 3D slag-type inclusions.

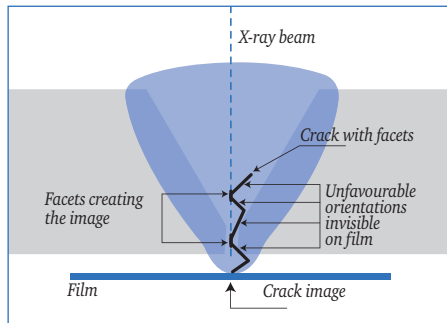

Fig. 16-17. Crack facets creating the defect image

In fact, LOF defects are in practice often detected because of the presence of these small inclusions rather than because of the LOF itself. Such secondary small defects do usually not occur along with cracks, although their character might be erratic and their small facets under different angles - some of them just in line with the X-ray beam - might help to detect them as illustrated in figure 16-17. From experiments it is known that, if more than 1 to 2% of the material in the line of radiation is missing, a defect is detectable.

### 3D CT for sizing of defects in (welded) components

To know the through-thickness size of a defect can be of paramount importance to calculate the strength of a cracked component, its remaining strength or its fitness for purpose. Traditional single-shot (and even multi-shot radiography) is unable to measure through-thickness height of planar defects.

Even detection itself is not always easy, as the previous paragraph describes. Therefore sizing of defects once detected with radiography is often done by ultrasonics, with acceptable sizing accuracies for engineering critical assessment (ECA) calculations.

The application of ultrasonics on welds requires that both the material and the weld are acoustically transparent. This requirement is often not met in welded or cast austenitic materials as used in nuclear power plants.

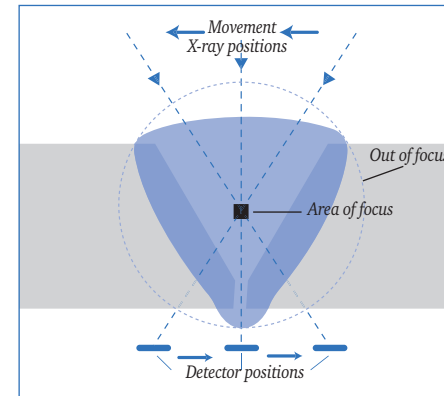

Fig. 17-17. Schematic of 3D CT defect detection and sizing

Such systems use common high-energy X-ray tubes with common focus dimensions of a few  $\text{mm}^2$ , in combination with line detector arrays. Figure 17-17 schematically shows the set-up for a series of exposures to create a 3D CT image. Synchronised and simultaneous movement of the X-ray source and the detector causes only a particular volume of the material (slice) to be "in focus". All information from the adjacent area is out of focus and does not contribute to the image of the defect. Many of such focus areas (volume pixels or "voxels") are stored, for instance a few hundreds per slice. If the detector has sufficient length, it does not need to move ("virtual movement").

In performing a CT scan, the X-ray beam goes through a wide range of angles including the angle(s) of the defect. Numerous slices are made, together resulting in a large number of voxels. On the basis of these many voxels the image of the entire defect can be reconstructed, including its position, orientation and depth location in the component. This can be done with considerable accuracy, typically 1mm or better; accurate enough for calculation purposes. Figure 18-17 shows a crack in an austenitic weld and next to its CT reconstruction. Figure 19-17 shows another example of a CT image obtained with this system. The image shows two planar defects in a V-shaped weld with a clear indication of their orientation and size.



Macro of crack in a weld  
Fig. 18-17. Crack in austenitic weld

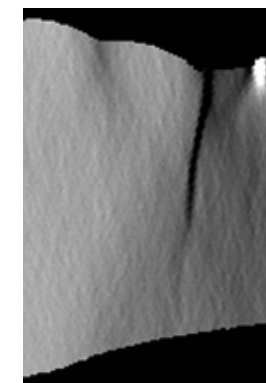

CT reconstruction of the crack

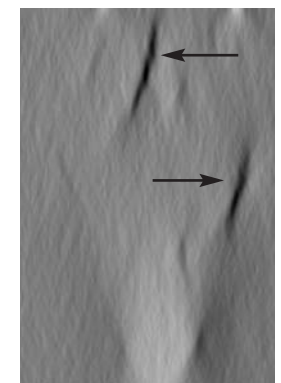

Fig. 19-17. CT reconstruction of two planar defects in a weld



Such 3D CT systems are primarily intended for defect analysis. Scanning of a girth weld typically takes about one hour. Inspection and reconstruction of one cross section takes less than 10 minutes. An example of such a system is the so-called TomoCAR\*\*\*, see “acknowledgments” at the end of this book. This system uses a CMOS line array and is capable to inspect (analyse) pipe diameters of up to 500 mm with a total irradiated thickness of up to 50 mm (2 x 25 mm). To analyse a defect in a circumferential weld the X-ray tube is at one side of the pipe and the detector is located diametrically (at 180°) at the other side. Both are moving synchronously. Condition for use is that there is enough space in the vicinity of the pipe/weld for the scanner to move.

## 17.5 Neutron radiography (neutrography)

Neutrons, which are atomic particles without an electric charge will penetrate most materials, are attenuated in passage, and so can be used to produce “radiographs”. There are various kinds of neutron energies, but only the thermal and cold neutrons are suitable for NDT applications. Contrary to ionising radiation in the keV and MeV range, neutron absorption is higher in light than in heavy materials. Neutrons will be strongly influenced by hydrogenous materials, plastics (all types), explosives, oil, water etc., even when these materials are inside metal containments made of lead, steel or aluminium.

There are many potential applications for neutrography, but its practical use is limited to a large extent by the lack of suitable, portable neutron sources. A neutron “window” in an atomic reactor is by far the best source, but such facilities are not commonly available. The only neutron-emitting radioactive source is Californium252, which is extremely costly and has a half-life of only 2.65 years. An X-ray film also reacts to neutron energy, but useable results are not obtained until it is combined with gadolinium or cadmium intensifying screens. The Agfa D3SC (SC = single coated) film is frequently used for this purpose. The secondary radiation generated in the intensifying screens brings about the image formation.

Another filmless application of neutron radiography in NDT is moisture detection in insulation. This portable equipment that is on the market uses a very weak neutron source. With the aid of this neutron backscatter method, the presence of water, actually that of hydrogen atoms, is established. The presence of moisture is generally an indication of external corrosion in a pipe, or the likelihood that corrosion will occur in the near future. The portable real-time equipment as described in section 17.3, or flash radiography described in section 18.7, can in some cases confirm the presence or absence of corrosion without removing the insulation.

## 17.6 Compton backscatter technique

The Compton backscatter technique, see section 2.6, benefited from the introduction of computer technology into NDT equipment, just as most other methods discussed in this chapter. This method is very attractive for objects with access from one side only. It is now an accepted NDT-technique for plastics and light metals [2].

The scanner comprises an X-ray tube and a detector consisting of a number of elements as illustrated in figure 13-17. A collimator reduces the beam of rays to 0.5 mm in diameter, so that it cannot irradiate the detectors directly.

When a photon and an electron collide in the material, the primary X-radiation is scattered as somewhat softer radiation in all directions, and thus partly also back from the material to the scanner. This secondary radiation is then caught by the detector through a specially shaped diaphragm, see figure 20-17. The detector is made up of 20 or more detector elements marked A', B', C' etc. each of which measures the quantity of back scattered radiation from a certain depth (A, B, C) in the object, as figure 20-17 shows. Each sensor element is, say, focussed at a certain depth.

The cylindrical scanner measures only 7 x 7 cm and scans the object in a grid. By linking the scanning system with a data processor, a comprehensive “Compton image” of the object develops and any possible defects in it. The Compton backscatter technique is for instance frequently applied to honeycomb constructions and composite materials and has a penetration depth of approximately 50 mm.

The method is (still) fairly slow; scanning a 50 cm<sup>2</sup> surface takes approximately 5 minutes. An added advantage is however that the depth position of defects becomes known immediately as a result of the “quasi-focussing” of each individual detector element.

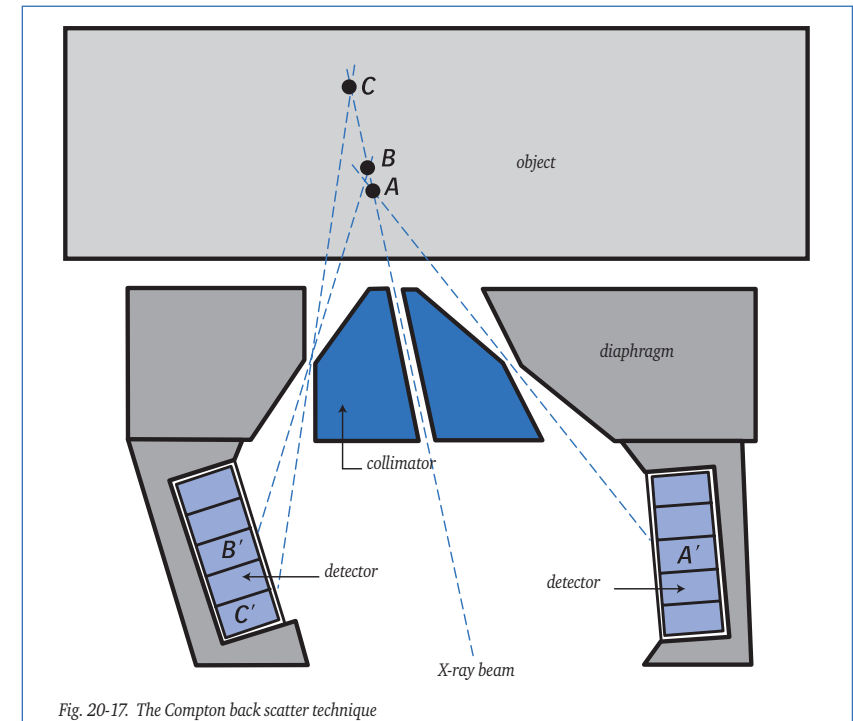
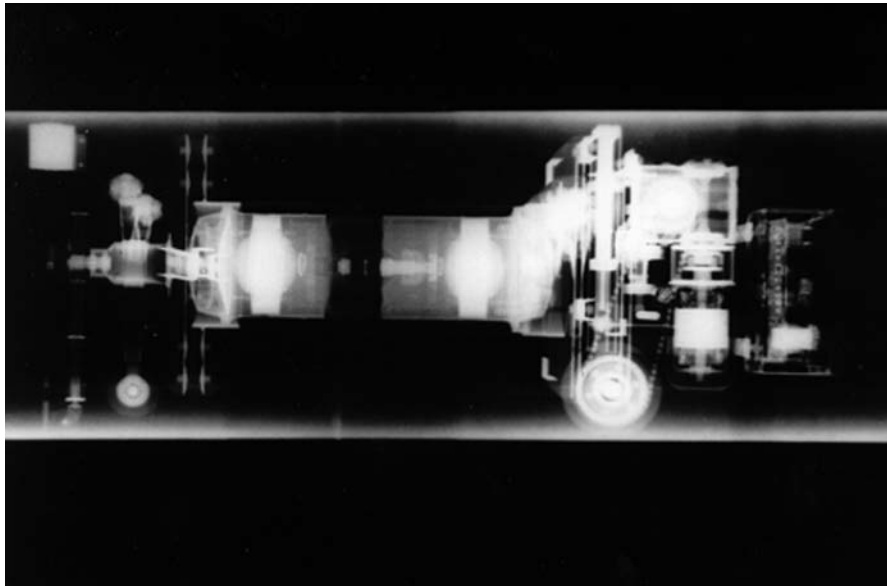

Fig. 20-17. The Compton back scatter technique



## 18 Special radiographic applications



*X-ray image of an X-ray crawler in pipe at weld location*

There are many special applications of radiography in NDT. This chapter describes a limited number of different examples to illustrate this diversity. Apart from the use of radiation in image forming radiography, it is also used in, for instance, measuring instruments such as metal alloy analysing instruments (Positive Material Identification, PMI) and humidity detection in insulation of thermally insulated piping. This type of non-image forming instruments and applications are outside the scope of this book.

### 18.1 Measuring the effective focal spot

The effective focal spot size is an important feature of an X-ray tube and is specified by the manufacturer. In general it can be said; “the smaller the better”. As focal spot size is a critical exposure parameter (see section 11.1) for a particular application, the accuracy of the manufacturer’s information is of vital importance.

Since 1999, EN 12543-1 requires a standardised method which, however, does not have the general support of suppliers, as it requires expensive instrumentation and is time-consuming. The EN-method, suitable for effective foci  $>0.2$  mm, involves scanning the X-ray tube radiation beam with a scintillation counter through a double collimator with an extremely small opening of 10  $\mu\text{m}$ . The resulting intensity values are then represented in a three-dimensional (isometric) diagram from which the effective focal spot can be deduced. EN 12543-1 replaces the (older) less accurate IEC 336 procedure. The values based on EN 12543 are often still reported together with data based on the IEC 336 procedure, for example: “3.5 mm (EN 12543) / 2.2 (IEC 336)”. The numbers based on the IEC refer to a look-up table from which the focal dimensions expressed in mm can be derived. Those dimensions are given with a wide tolerance. In fact the IEC values were too inaccurate to calculate image sharpness, being the main reason to develop the EN-procedure. Manufacturers of X-ray tubes usually apply the so called Sténopé pinhole technique (camera obscura) to determine focal spot size.

The X-ray tube projects its focus through a very small hole (pinhole) in a lead plate onto a film. The lead plate is positioned exactly halfway between focus and film. To prevent scattered radiation, the hole is sometimes made in a tungsten plug which forms part of the lead plate. After development, the effective focal spot size can be measured on the film, with the aid of a magnifying glass. The latter method, still allowed and accepted by EN, results in marginally smaller effective focal spot sizes.

Establishing the effective focal spot size of a panoramic X-ray tube is considerably more complicated. To circumvent this, it is therefore recommended to just make a radiograph of the object - pipe or vessel weld - with the right IQI’s and check the results for compliance with the quality requirements specified.

## 18.2 Radiographs of objects of varying wall thickness

For radiographs of an object with limited differences in wall thickness, it is common to base exposure time on the average thickness to obtain the required film density of at least 2. It is possible that parts of the film are either under- or over-exposed if there are great differences in wall thickness. This can be explained by the shape of the toe (lower part) of the characteristic curve of the X-ray film used. The film gradient (contrast) is lower and, consequently, so is the defect discernibility. In accordance with EN 1435, therefore, there is a limit to the thickness range covered by one single exposure.

There are a number of practical ways to prevent over-exposure of thinner and under-exposure of thicker sections. These can be divided in two groups: compensation by single film or by two film techniques.

**For exposures on one film, the following techniques can be applied:**

- Reduce contrast by utilizing a filter on the X-ray tube to make the radiation harder.
- Reduce contrast by increasing the radiation energy using higher tube voltage or using Iridium192 or Cobalt60 sources.
- Compensate the difference in wall thickness as the left sketch of figure 1-18 shows, with material B of similar composition as object A.
- Instead of insertion of B in the previous method, use a special putty (filling material) mainly consisting of metal powder.

**When two films are used, the following techniques can be applied:**

- Simultaneous use of two films of different sensitivity but similar screens, for a single exposure. For example an Agfa D7 and D4 type film could be used. This is the least complicated and most practical method (see figure 1-18 at right).
- Simultaneous exposure on Agfa D7 and D4 films with different screens (see figure 1-18).
- Make two exposures on film of the same sensitivity and screen type: one with the exposure time based on the thinner and one on the thicker section.
- Make two exposures on film of the same sensitivity but different screen types.

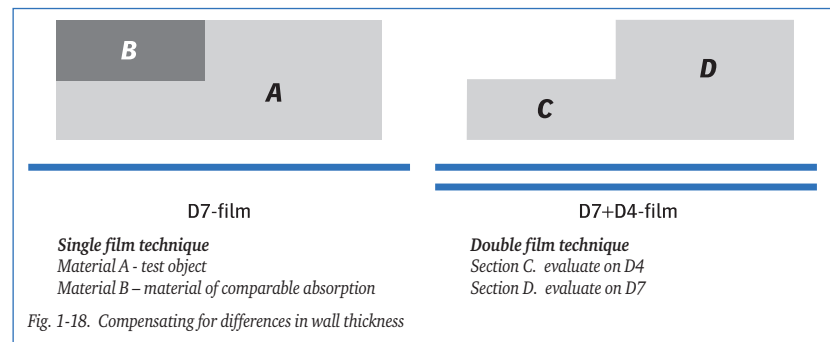

## 18.3 Radiography of welds in small diameter pipes

For pipe welds, the single wall-single image technique (SW-SI), or if this is not feasible, the double wall-single image technique (DW-SI) is to be applied. For small diameter pipes this alternative is not really practical, as a disproportionate number of double wall-single image exposures needs to be made due to the limited effective film length (see section 12.2). In such a case the double wall-double image technique should be used (DW-DI). Normally, the DW-DI technique is only applied on diameters <75 mm and wall thickness of <8 mm. Both, the weld on the source side and film side of the pipe are simultaneously interpreted.

Two more DW-DI techniques are suitable for small diameter pipes:

- the elliptical technique and
- the perpendicular technique

**Elliptical technique**

The elliptical technique, as illustrated in figure 2-18, is the preferred technique, but should only be applied if the following conditions are met:

- external diameter ( $D_e$ ) is <100 mm (in practice 75 mm)
- wall thickness ( $t$ ) is <8 mm
- weld width <  $D_e/4$

The number of exposures is determined by the relation between wall thickness ( $t$ ) and diameter ( $D_e$ ). If  $t / D_e$  is < 0.12, two images - rotated 90° in relation to each other - are sufficient for 100 % coverage. If  $t / D_e$  is equal to or bigger than 0.12, three exposures - rotated 60 or 120° in relation to each other (i.e. equally divided over the circumference) - is considered to be a 100 % examination.

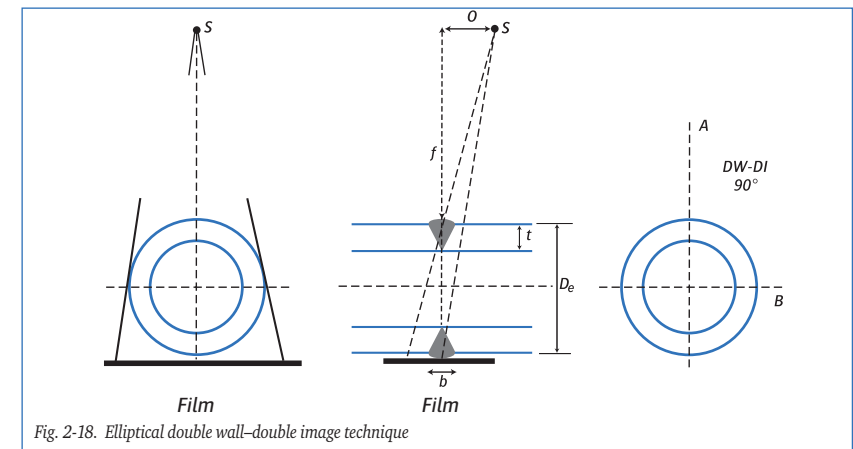

When using the elliptical exposure technique, the images of the weld on the source side and on the film side are shown separately, next to each other. The distance between two weld images has to be approximately one weld width. This requires a certain amount of source offset (O), relative to the perpendicular through the weld. The offset can be calculated with the following formula :

$$O = 1.2 \cdot w \cdot f / D_e$$

In which:

$w$  = width of the weld

$f$  = distance from source to the source side of the object, measured perpendicularly

$D_e$  = external pipe diameter

$O$  = Offset distance

### Perpendicular technique

Alternatively, the perpendicular technique can be used if the elliptical technique is not practical, (see fig. 3-18). This is the case when, for instance, pipes of different wall thickness are joined or a pipe is joined to a 45° / 90° bend.

Three exposures equally divided over the circumference are sufficient for 100% coverage.

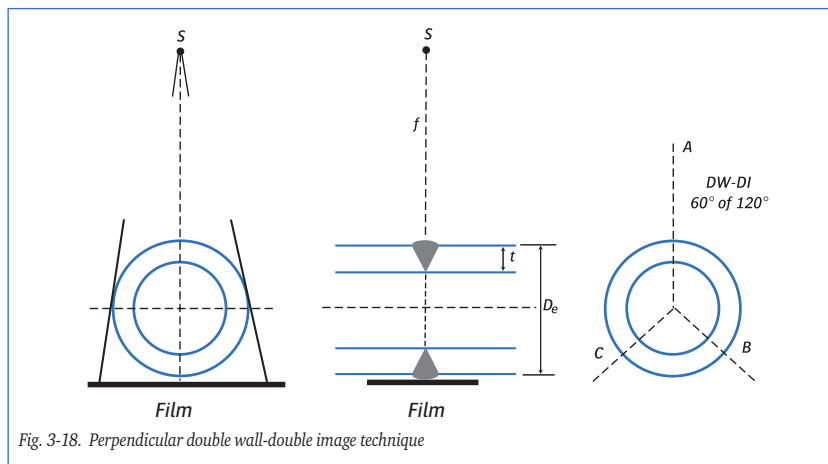

### 18.4 Determination the depth position of a defect

The depth position (d) of a defect can be determined by the parallax-method, as shown in figure 4-18. The radiograph is exposed from two opposite angles. The required quantity of radiation is equally divided over positions A and B. Only one film is used.

The shift in defect image on the film (G in mm) is a measure for the depth position; the shift of the source (A to B in mm) and the source-to-film distance (H in mm) are important data. The depth position is calculated with the formula:  $d = (G \times H) / (AB + G)$ .

Another, much more complex method of depth determination is stereo-radiography, by which two separate films are exposed which are viewed simultaneously via mirrors. However, this method is rarely used.

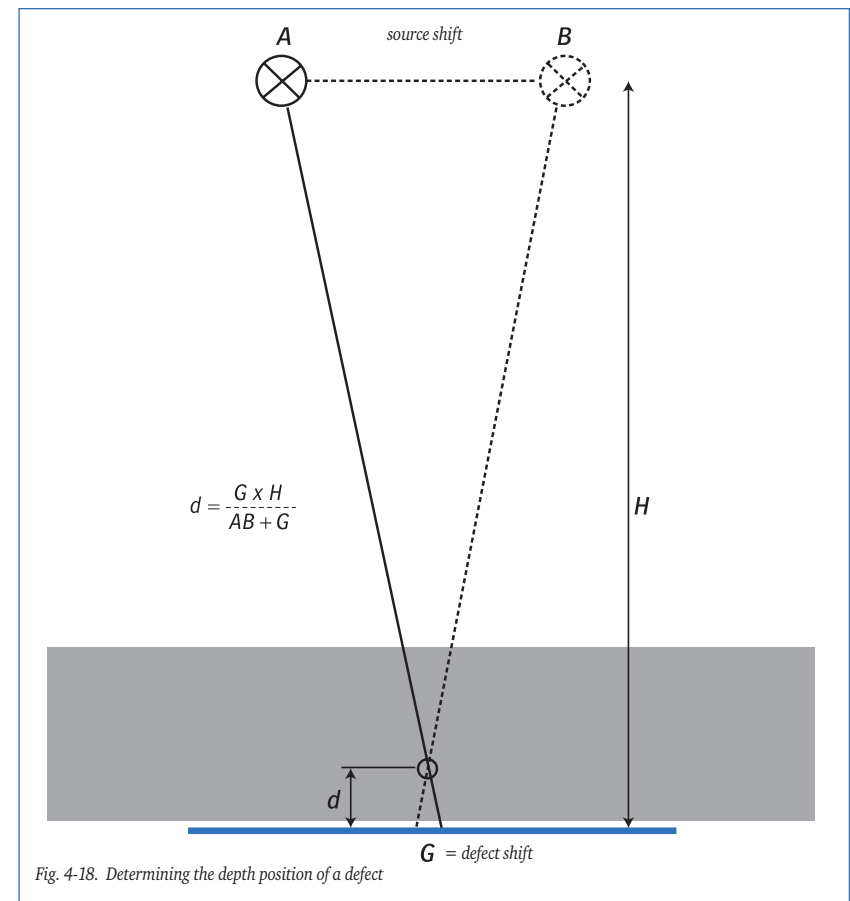



## 18.5 Determination the depth position and diameter of reinforcement steel in concrete

Similar to the method for determination of the depth position of a defect in metals is the determination of the depth position (cover) of reinforcement steel in concrete. Subsequently, the true diameter of the reinforcing bar (D) can be calculated. Correction factor =  $d / (H-d)$ .

The dimension of the radiographic image ( $D_f$ ) on the film is multiplied by this correction factor. The true diameter of the reinforcing steel is therefore  $D = D_f \cdot d / (H-d)$ .

## 18.6 On-stream inspection - profiling technique

On-stream inspection can be carried out on pipes, valves, vessels, and distillation columns while in operation, in order to establish the degree of deterioration of the system either the projection or the tangential technique can be used. Since the introduction of digital radiography, the CR-method using storage phosphorplates, is increasingly becoming an alternative for traditional film in case of on-stream exposures, see chapter 16. The main advantage being that it reduces the exposure time by a factor of 5 to 10, or if lower energies (Iridium192 instead of Cobalt60) can be applied it results in a reduced controlled area, which is very attractive in cramped spaces and personnel nearby e.g. on offshore platforms.

### Projection technique

The projection technique is most commonly used. With this technique the two walls are projected on film simultaneously, as shown in figure 5-18. The image projected is larger than the actual object dimensions. It is important to know the degree of magnification so as to be able to determine the true wall thickness. If both walls of the pipe are projected on the film, it is straight forward to establish the correction factor, which is the true diameter (D) divided by the radiographic diameter  $D_f$ . This method should be used as much as possible.

With the projection technique, the source is placed at a certain distance from the pipe. At a film-to-focus distance of  $3 \times D_{insulation}$  and a source size of 3 mm, image quality requirement A of EN 1435 is met.

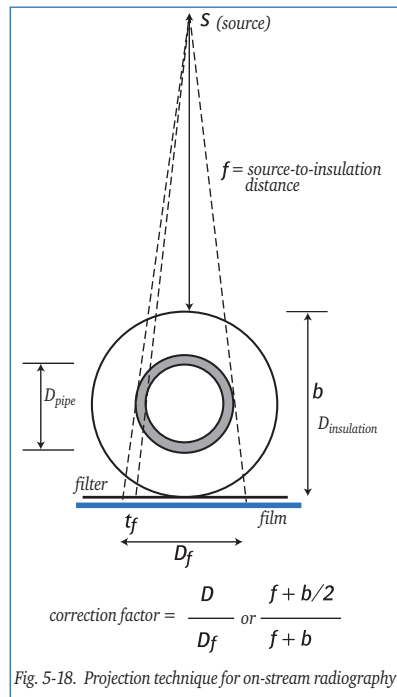

Fig. 5-18. Projection technique for on-stream radiography

The actual pipe wall thickness (t) is equal to the image on film ( $t_f$ ) multiplied by the correction factor (see fig. 5-18).

Most common is on-stream radiography of insulated pipes, for which half the insulated diameter determines the sharpness. In on-stream radiography it is important to know the direction of the product flow, so that a existence of localised wall thickness reduction can be better deduced. Films of 30 x 40 cm are generally used for pipe diameters up to 250 mm. Larger diameters require more films.

### Tangential technique

In the pipe diameter range of 250 to 400 mm the tangential technique, as shown in figure 6-18 is sometimes applied. Only one wall is projected. The perpendicular projection produces a sharper image. This allows a shorter focus-to-film distance, and consequently a shorter exposure time. Generally, a focus-to-film distance of  $2.5 \times D_{insulation}$  is chosen.

The correction factor would then be:  $(2.5 \times D_{insulation} - 0.5 \times D_{insulation}) / 2.5 \times D_{insulation} = 0.8$ .

### Selection of source, screens and filters

The graph in figure 7-18 indicates which radioactive source is the most suitable, depending on pipe diameter and wall thickness. The quality of the radiograph can be optimised by applying filters and screens, see table 1-18.

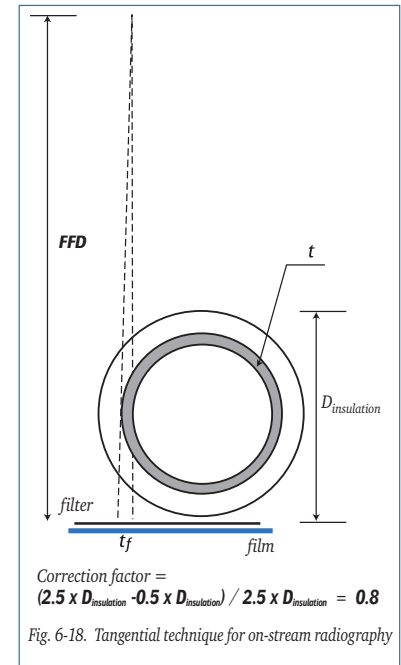

Fig. 6-18. Tangential technique for on-stream radiography

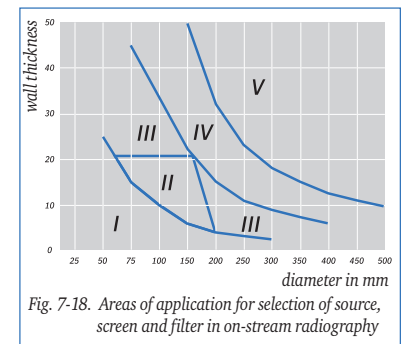

Fig. 7-18. Areas of application for selection of source, screen and filter in on-stream radiography

This graph appears enlarged in the appendix.

Zone	Source type	Source size	Screens front and back	Filter
I	Iridium192	2 mm	0.027 mm Pb	1 mm Pb
II	Iridium192	2 mm	0.027 mm Pb	2 mm Pb
III	Cobalt60	3 mm	0.5 mm Cu of RVS	1 mm Pb
IV	Cobalt60	3 mm	0.5 mm Cu of RVS	2 mm Pb
V	Cobalt60	4 mm	0.5 mm Cu of RVS	4 mm Pb

Table 1-18. Selection of source, screen and filter for the various areas in figure 7-18.



### Exposure time

Obviously different exposure times are required for gas filled or liquid filled pipelines. Below are a few examples.

#### For gas filled pipelines:

Depending on diameter and wall thickness	: Iridium192 or Cobalt60, see figure 7-18
Focus-to-film distance	: minimum $3 \times D_{\text{insulation}}$
Irradiated thickness	: 2 x nominal wall thickness
Film type	: minimum C5 (EN584-1)
Film density	: minimum 2.5 in the centre of the pipe projection

#### For liquid filled pipelines:

Depending on the diameter, wall thickness	: Iridium192 or Cobalt60
Focus-to-film distance	: minimum $3 \times D_{\text{insulation}}$
Irradiated thickness	: 2 x nominal wall thickness plus steel equivalent of the pipe content
Film type	: minimum C5 (EN584-1)
Film density	: minimum 2.5 in the centre of the pipe projection

The steel equivalent of the pipe content is determined as follows:

$(\text{specific density in kg/m}^3 \text{ of content}) / (\text{specific density in kg/m}^3 \text{ of steel}) \times \text{internal diameter}$   
= .... mm of steel

Density of steel = 7.800 kg/m<sup>3</sup>

Density of content (oil and aqueous liquids) = 800 to 1.000 kg/m<sup>3</sup>



Fig. 8-18. Preparations for on-stream radiography

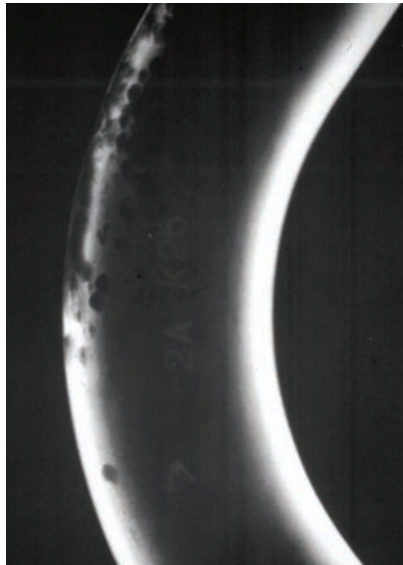

Fig. 9-18. On-stream radiography of pipe with corrosion

Notes:

- In the most commonly used insulation materials absorption is negligible.
- The long exposure times cause over-irradiation at the edge of the pipe. As a result the pipe wall shows up 'thinner'.

Figure 8-18 shows preparations for on-stream radiography being made. The end piece for the gamma-source is positioned above the pipe, while the flat film cassette is placed below. Figure 9-18 shows an on-stream radiograph of a pipe with severe pitting corrosion. Since the introduction of digital radiography the CR-method, using storage fosporplates, is rapidly becoming an alternative for traditional film. The main advantage being that it reduces the exposure time by a factor of up to 10, or if weaker sources can be applied a reduced controlled area which is very attractive in cramped spaces e.g. offshore platforms, see chapter 16. In industry this area is often called "safety area", which is wrong, to the contrary, it is an unsafe area with highest radiation close to the source.

## 18.7 Flash radiography

Flash radiography or pulse radiography can be carried out when information is required about the condition of the outer surface of an insulated pipe, without having to remove the insulation.

Figure 10-18 shows flash radiography in progress. Since only the aluminium cladding and insulation need to be penetrated, relatively soft radiation is applied, while exposure time is limited to only a fraction of a second. In that time sufficient "pulsed radiation" is generated. to create an image on the superfast F8 + NDT 1200 (film+screen combination) see section 6.3. It is safe to make radiographs manually without the need for additional safety arrangements. Systems up to 200 kV exist (Golden Inspector) suitable to penetrate 10 mm wall thickness of steel.



Fig. 10-18. Flash radiography of an insulated pipe section

## 18.8 Radiography of welds in large diameter pipes

To create an on- or offshore pipeline individual pipes (length usually 12 m) or pipe sections (double or multiple joints) are welded together by a circumferential weld, a so-called girth weld.

Onshore production rates can be far beyond 100 welds per day dependent on pipe diameter and terrain conditions. On lay barges, used for production of offshore pipelines, more than 300 welds per day (24 hours) are no exception.

According to applicable (mandatory) norms and specifications these welds have to be inspected either with radiography (RT) or automated ultrasonic testing systems (AUT).

In the past the inspection was exclusively done by RT, in more recent years AUT increasingly replaces RT. One attractive feature of AUT is that, contrary to traditional RT - using film - the results are instantly available.

Nevertheless for many pipelines RT - using X-rays or sometimes gamma rays - is still in use to check weld quality. To eliminate development time of the film several attempts in the past to replace traditional RT by RTR (real time radiography) providing instant results have only resulted in limited success, mainly due to lack of image quality.

In the meantime some of such systems have entered the market and are in use. Although no EN standards exist (essential to conquer a market share) some other standards accept digital real time radiography providing one can prove that the required image quality can be achieved, see chapter 16.

Attempts continue to develop better RTR systems than already exist.

Development of radiation sensitive sensor technology is still in full progress and has the potential to ultimately meet the required image quality which at present only can be achieved by using traditional film.

To cope with the high weld production rates, thus limited time available for inspection, the RT-process has been fully optimised. On land, with sufficient exposure time available, it is common practice to develop and judge the films only once or twice the same day. Repair can be done afterwards.

For offshore work this process is impossible. Each weld has to be judged instantly and if necessary be immediately repaired before a new one can be made, because a lay barge in general only moves forward. For a full cycle, exposure and development of the film and its interpretation, approximately five minutes are available in case of an S-lay situation. For the more complex J-lay situation - applied in deep waters - in general more time is available, so inspection time, although still at the critical path, is less critical.

To optimise the inspection process first of all X-ray crawlers with control units have been developed in combination with very accurate positioning devices as illustrated in figure 11-18.

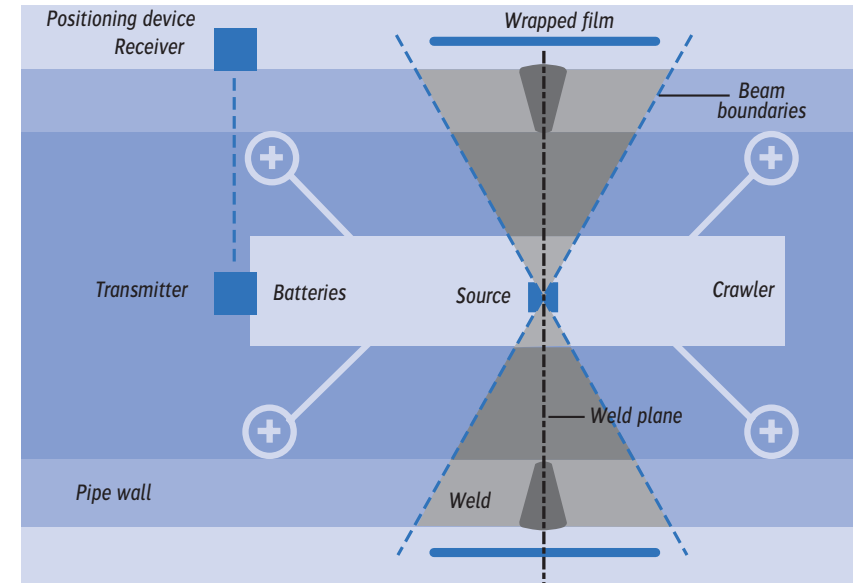

Fig. 11 - 18. Concept of girth weld inspection

This positioning device is used to stop the crawler at the correct X-ray tube position (within a few millimetres) with regard to the weld plane in order to make a true panoramic exposure of the weld.

Usually the crawlers are self-contained and electrically driven. Most of them are powered by heavy duty batteries or sometimes by a motor-generator for the larger diameters, see figure 12-18. Such crawlers must be very reliable to limit cut-outs in case of brake down onshore or avoid costly loss of time on lay barges. Such crawlers are equipped with X-ray tubes with true panoramic (conical) beam to create a full circumferential exposure in one shot.

Although the resulting image quality is less than with X-ray sometimes radioactive sources are allowed. Figure 13-18 shows a battery powered gamma-ray crawler.

Usually crawlers are built according to a “fail safe” design to avoid spontaneous radiation, not triggered by the operator.



Fig. 12-18. Large diameter X-ray crawler with motor generator.



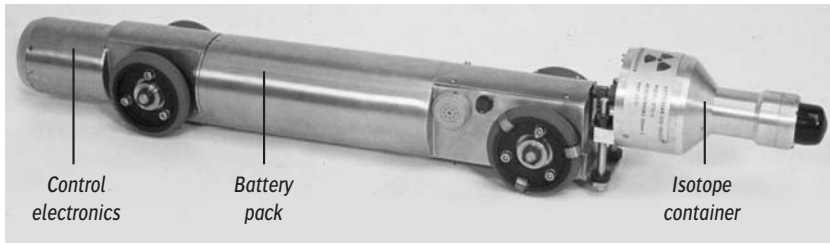

Fig. 13-18 Small diameter gamma-ray crawler

Positioning devices using different physical methods are used to stop the crawler, and thus the source of radiation, at the correct position (at the weld plane). These positioning devices have to transmit or receive a position signal through the (often thick) pipe wall. Despite its radiation and related risks, low activity radioactive sources are often used either in or outside the pipe in combination with collimated detectors to achieve the required positioning accuracy.

Most attractive, for obvious reasons, are positioning devices not using radioactive isotopes. With these control/positioning devices also the commands to the crawler are given for “exposure”, “forward” to the next weld or “reverse”. Prior to arrival of the crawler at the next weld the positioning device is accurately positioned on the pipe near this next weld to stop the crawler. To increase its stop accuracy, at first the crawler is slowed down, at reduced speed the crawler is stopped in order to achieve the highest possible position accuracy of the radiation source.



Fig. 14-18. Preparation of strip film on girth weld

Crawler- and control technologies for on- and offshore application are almost the same. The choice of film can be different. For onshore application traditional film is used, in general type D4-film or equivalent with a common developing process.

For lay barges, requiring the shortest possible cycle time, often high speed film (RCF- rapid cycle film, see chapter 8) in combination with special developer and fixer is applied.

Instead of using standard film lengths it is much more efficient to use a long strip of film to be wrapped around the pipe as illustrated in figure 14-18, e.g Agfa Rollpac, with a length covering the circumference including a small overlap.

Strip film with and without lead screens exists in different widths. They are packed in boxes with lengths up to 100 metres.

For large projects pre-cut films at specified lengths with sealed ends exist. For onshore application of X-ray crawlers the required radiation safety is easily achieved by distance and all other related safety measures and warning signs.

On a lay barge, crowded with people, this is not as easy. Here as a first measure radiation reduction is largely achieved by a lead tunnel as shown in figure 15-18.

Moreover high speed film requiring a lower dose than traditional film, thus requiring a lower source activity or lower mA-value, or shorter exposure times, contribute to reduce radiation.

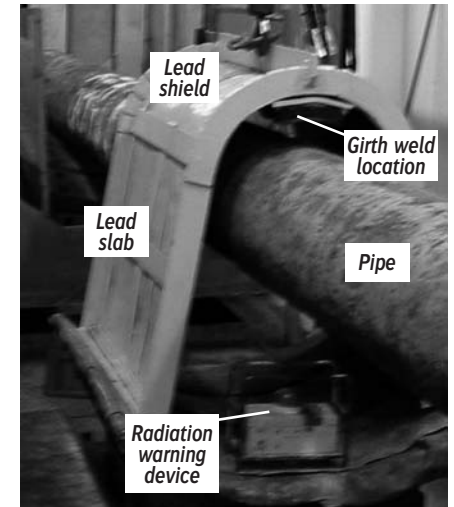

Fig.15-18. Lead radiation protection tunnel



## 19 Radiation hazards, measuring- and recording instruments

### 19.1 The effects of radiation on the human body

The human body is constantly exposed to natural radiation (e.g. from space, the soil and buildings), also known as background radiation. All ionising radiation, whether electromagnetic (gamma- $\gamma$ ) or corpuscular (particles in the form of alpha- $\alpha$  or beta- $\beta$ ), and neutrons, are harmful to the human body. The unit “absorbed dose” (D) defines the effect of radiation on various substances. D is the absorbed dose in J/kg or Gray (Gy).

The biological damage done by the various types of ionising radiation,  $\alpha$ ,  $\beta$ ,  $\gamma$  or fast neutrons, differs and depends on the quality factor (Q). The unit to which the damage quality factor is applied is the equivalent dose H.

The equivalent dose is the product of absorbed dose (D) and quality factor (Q), so the equivalent dose is calculated as  $H = D \cdot Q$  [Sv], (Sv = Sievert).

The Q factors for various types of radiation are indicated in table 1-19.

Type of radiation	Quality factor (Q)
X and gamma radiation ( $\gamma$ )	1
Beta radiation ( $\beta$ )	1
Alpha radiation ( $\alpha$ )	20
Fast neutrons	10

Table 1-19. Q-factors for various types of radiation

### 19.2 Responsibilities

#### The client

It is the client’s responsibility to consider possible alternatives before utilising ionising radiation. Considering its purpose, the decision to use ionising radiation can only be justified when the radiation hazard remains at an acceptable level.

#### The radiographer

It is primarily the radiographer’s responsibility to protect himself and others from exposure to radiation.

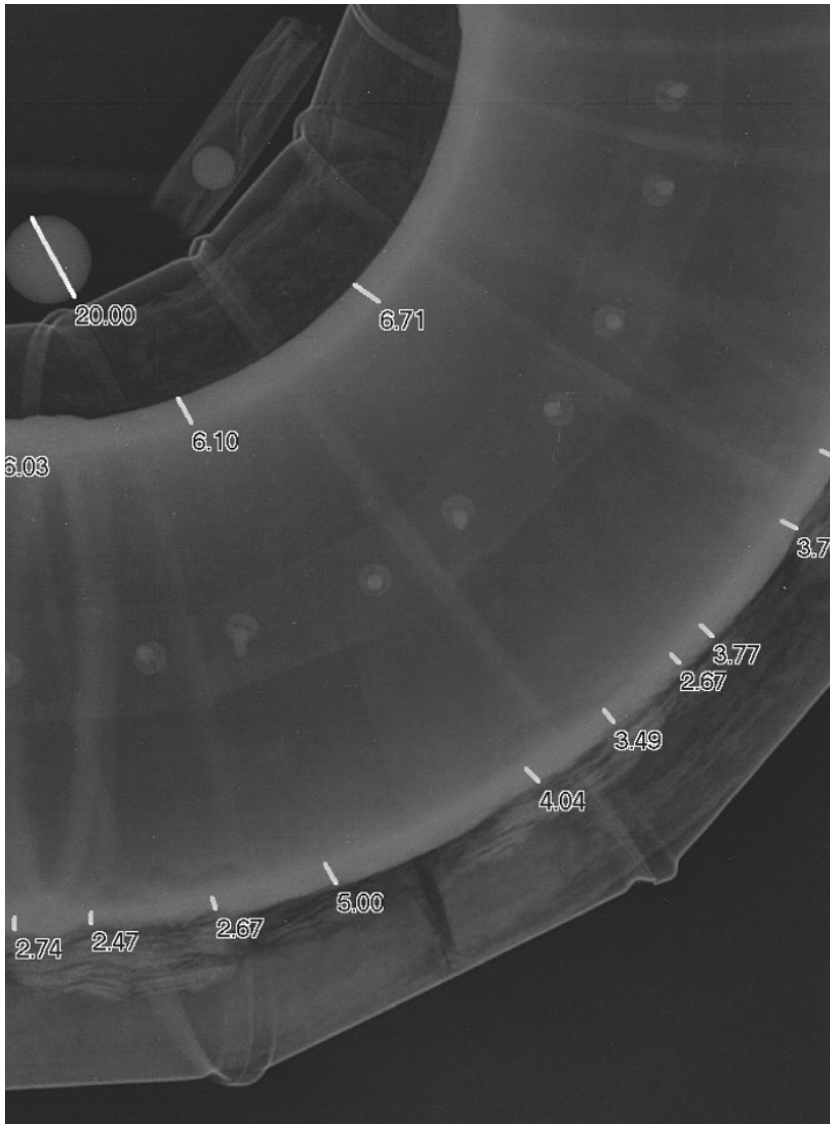

On stream image of insulated pipe

CR-image of a weld  
see acknowledgements\*



### 19.3 The effects of exposure to radiation

The understanding of the effect that exposure to radiation has on human beings has grown over the past 50 years and has led to a substantial reduction of the maximum permissible dose.

There are two categories of biological effects that an overdose of radiation can cause: somatic and genetic effects. Somatic effects are the physical effects.

A reduction in the number of white blood cells is an example of a somatic effect. Much more is known about the somatic than about the genetic effects of radiation.

Blood cells are very sensitive and the first signs of radiation are found in the blood, which is why people working in radiology are subjected to periodic blood tests.

The most serious effects of radiation occur when a large dose is received in a short period of time. Table 2-19 shows doses received over 24 hours and their effects:

Dose received by the body	Effects
0.0 - 0.25 Sv	No noticeable effects
0.25 - 0.5 Sv	Limited temporary changes in the blood
0.5 - 1.0 Sv	Nausea, fatigue
2.0 - 2.5 Sv	First lethal cases
5.0 Sv	50 % lethal (MLD = medical lethal dose)

Table 2-19. Effects of radiation doses

The consequences of excess radiation are not necessarily noticeable immediately after the irradiation. Frequently, they only show up after some time. The time lapse between irradiation and the moment the effects become apparent is called “the latent period”.

Genetic effects can only be assessed over generations.

### 19.4 Protection against radiation

The International Commission on Radiation Protection (ICRP), a division of the International Atomic Energy Agency (IAEA), is engaged in providing rules and regulations for the protection against radiation, as the name suggests. The ICRP has established the values for radiological and non-radiological workers, as indicated in section 19.5.

Practically all countries have brought their national legislation (laws) on ionising radiation in line with the ICRP codes. The conditions for registration, transport, storage, protection and the expertise of preparation and use of radiation sources have been laid down in regulations. The purpose of practical protection against radiation is to prevent any individual receiving a harmful dose.

As there is considered to be no totally safe lower limit below which no damage would be sustained, the “ALARA” concept is being promoted. ALARA (short for As Low As Reasonably Achievable), aims to achieve the lowest possible radiation dose whereby economic and social factors are considered.

The protection from unwanted external irradiation is based on three principles:

- Speed: by working fast, the exposure duration is reduced.
- Distance: the greater the distance, the lower the rate of exposure (remember the inverse square law).
- Shielding and collimating: materials with high radiation absorbing properties, such as lead, reduce the exposure rate to a level that can be calculated in advance.

Table 3-19 in section 19.8 shows the half-value thickness of lead for various gamma sources.

### 19.5 Permissible cumulative dose of radiation

Although the subject of permissible cumulative dose of radiation is complex, the values given below apply to external irradiation of the whole body.

The values have been established by the ICRP.

- Radiology workers, category A: 20 mSv/year
- Radiology workers, category B: 5 mSv/year
- Public, not being radiology workers: 1 mSv/year

The whole body level of 20 mSv per year is normally interpolated as 0.4 mSv per week and 10 µSv/h at a 40 hr working week.

These levels are acceptable but it is not to be automatically assumed that people working with radiation actually should receive these doses.

When radiography is carried out in factories and on construction yards etc. special consideration is required for non-radiological workers and demarcation of the area in which radiation is used, and a maximum dose rate of 10 µSv/h applies, is essential.

This is also the maximum value to be measured at the outside surface of a charged isotope container.



## 19.6 Radiation measurement and recording instruments

From what has been said before, it follows that establishing the presence of ionising radiation and measuring its level is of paramount importance. Since ionising radiation cannot be detected by the senses, detectors and measuring equipment are used. There are various instruments with which the radiographer can measure or register radiation.

The most common measuring instruments are:

1. Dose rate meters
2. Scintillation counters

The most common instruments for personal protection are:

3. Podosimeter (PDM)
4. Thermoluminescent badge (TLD)
5. Film badge

### Radiation measuring instruments

#### Dose rate meters

A portable Geiger-Müller counter of 7 x 15 x 4 cm, see figure 1-19, is the most commonly used instrument for measuring dose rate, but the more accurate and more expensive ionisation chamber is used as radiation monitor as well. Both instruments measure the electric current that is produced by ionisation.

The radiation level can be read instantly off a micro-ampere meter with a  $\mu\text{Sv/h}$  or  $\text{mSv/h}$  calibrated scale. Some radiation monitors give an audible signal when a pre-set dose is exceeded.

The instruments are used by personnel working with radioactive material or X-ray equipment, to determine the safe distance and the dose rate of for instance  $10 \mu\text{Sv/h}$  at the safety barrier. A GM-counter has a measuring range from  $1 \mu\text{Sv/h}$  to  $2 \text{mSv/h}$ .



Fig.1-19. Geiger-Müller counter

#### Scintillation counter

This is an accurate and multifunctional instrument to measure and analyse radiation. The incidence of ionising radiation on a Sodium-iodine crystal is converted into weak light flashes, which are amplified into electric pulses by an integrated photo-multiplier. By measuring amplitude and number of these electric pulses, energy and intensity (dose rate) of the radiation can be determined. These instruments are predominantly used for scientific purposes.

### Personal protection equipment

#### Podosimeter (PDM)

The PDM consists of a quartz fibre electrometer and a simple optic lens system housed in a fountain pen type holder, see figure 2-19.

A small charging unit is used to electrically charge the fibre, which can then be viewed through the lens.

The fibre is set on the zero mark of the calibrated scale as initial setting for the work period.



Fig. 2-19. Podosimeter

Any radiation will cause the charge to leak away through its ionising effect and the fibre will move across the scale. The amount of radiation received can be read off the calibrated scale.

This type of instrument is excellent for personal protection as it is small, inexpensive and reasonably robust. It can be easily read and records the total amount of radiation received for the work period with an accuracy of  $\pm 10\%$ .

#### Thermoluminescent dose meter (TLD badge)

The TLD meter consists of an aluminium plate with circular apertures. Two of these contain luminescent crystals. Figure 3-19 shows an open TLD-meter and the plate with crystals next to it. The right side of the illustration shows the same meter, now closed. When the meter is read only one crystal is used to determine the monthly dose. The other one is spare and, if necessary, can be read to determine the cumulative dose. The TLD meter is sensitive to X- and gamma radiation of 30 keV and higher. The dose measuring range is large and runs from 0.04 mSv to 100 mSv with an accuracy of  $\pm 5\%$ .

The instrument measures 60 x 40 x 10 mm and is convenient to wear

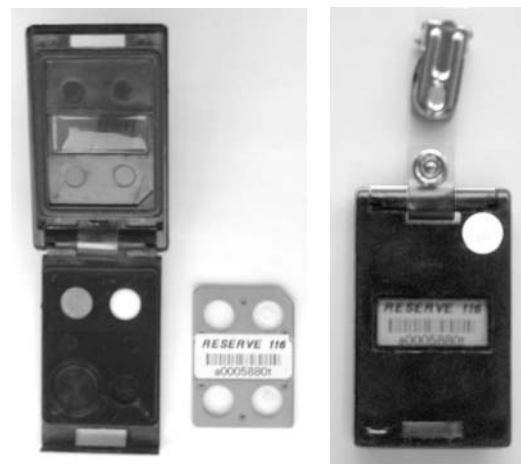

Fig. 3-19. Open TLD meter

Closed TLD meter

### Film dose meter (film badge)

The film badge consists of two pieces of X-ray film contained, with filters, in a special holder. At the end of a specified period, the films are developed and the density measured.

The radiation dose received by the wearer can then be determined by consulting the density/exposure curves, and the type of radiation received can be established by checking the densities behind the filters. Film dose meters as illustrated in figure 4-19 are a very cheap and reasonably accurate method of monitoring personnel in selected areas. They measure 25 x 25 x 5 mm, are robust and convenient to wear.

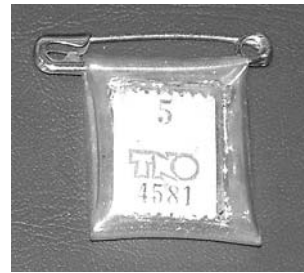

Fig. 4-19. Film dosimeter (film badge)

### 19.7 Dose registration

Due to legally required monitoring and registration of radiation doses received by radiological workers over a specified period of time, dose meters must be worn. Generally, these are TLD or film badges. The TLD-meter is preferred over the film badge as it is read out electronically and can be linked to a data base. Processing film badges is more complicated. The films must first be developed before they can be viewed to quantify and register the radiation dose.

Radiation dose monitoring is carried out by a government-authorized organisation which is responsible for mailing, processing and viewing of the badges. This organisation generates reports, which contain the individual irradiation doses over a specified period of time, as well as the accumulated dose.

### 19.8 Radiation shielding

Protection from radiation (best by distance) can consist of ribbons or ropes and warning flags to demarcate the area where radiographs are made, or concrete bunkers with doors which automatically switch off the X-ray equipment as soon as they are opened.

Both methods have the same objective: i.e. to prevent unauthorised people entering the area of radiation.

An area of radiation can be defined as an area in which the radiation level exceeds the permitted value of 10  $\mu\text{Sv/h}$ .

There are three ways to achieve a reduction in intensity:

1. by erecting a demarcation barrier at an appropriate distance,
2. by erecting an absorbing barrier,
3. by a combination of methods 1 and 2.

### Distance

Since radiation is subjected to the inverse square law, its intensity is reduced with the increase in distance to the square.

### Absorbing barrier and distance

Whenever radiation penetrates a material, the absorption process reduces its intensity. By placing a high-density material such as lead around the source of radiation, the quantity of transmitted radiation will decrease. To determine the material thickness required for a certain reduction in radiation, a factor known as the half-value thickness (HVT) is used.

Table 3-19 shows the HVT-values for lead for various types of gamma sources

Symbol	Average energy in MeV	Half-value thickness in mm lead
Cesium137	0.66	8.4
Cobalt60	1.25	13
Iridium192	0.45	2.8
Selenium75	0.32	2.0
Ytterbium169	0.2	1.0
Thulium170	0.072	0.6

Table 3-19. Half-value thicknesses for lead using different types of gamma sources

### Example

To reduce 2.56 mSv/h, measured at 1 meter distance, to 10  $\mu\text{Sv/h}$  the required distance according the inverse square law is  $\sqrt{2560/10} = 16$  metres. To achieve the same by placing a shield, the number of HVTs is calculated as follows:

Required intensity reduction is  $2560 / 10 = 256 \times$   
 Number of HVTs is,  $\log 256 / \log 2 = 8$

The example above demonstrates that an intensity of 2.56 mSv/h can be reduced to 10  $\mu\text{Sv/h}$  by increasing the distance to 16 metres, or place shielding material of 8 HVTs as close as possible to the source. If either of these methods cannot be used on its own, a combination of the two could be considered.



## 20 Standards, literature/references, acknowledgements and appendices

### European norms (EN-standards)

Ever since the introduction of industrial radiography, there has been a growing need for standardisation of examination techniques and procedures. At first, these standards had mainly a national character, e.g. ASTM and ASME, DIN, AFNOR, BS, JIS etc, but as a result of industrial globalisation the need for international standards grew. The national standards were, and still are, frequently used internationally, in particular the ASTM and ASME standards. International standards are largely based on existing national standards. Organisations that engage in international standardisation are ISO and CEN. These standards are developed by working groups of experts, who present the newly adapted (harmonised) standards to the ISO, CEN etc.

A number of European norms (EN) relevant to radiography are listed in table 1-20.

Norm number	Subject
EN 444	General principles for radiographic examination of metallic materials by X- and gamma rays
EN 13068-3	General principles of radiosopic testing of metallic materials by X- and gamma rays
EN 462-1 through 5	Image quality of radiographs IQIs
EN 473	Qualification and certification of NDT personnel
EN 584-1 Equivalents: ASTM E-1815 ISO 11699-1 JIS-K7627	Classification of film systems
EN/ISO 14096	Film digitisation
EN 584-2 ISO 11699-2	Verification of film systems
EN 1435	Radiographic examination of welded joints
EN 12543-1 through 5 replaces IEC 336	Characteristics of focal spots in industrial X-ray systems for use in NDT
EN 12544-1 through 3	Measurement and evaluation of the X-ray tube voltage
EN 13068	Fluoroscopic/radioscopic testing
EN 25580	Industrial radiographic illuminators minimum requirements
EN 14784 1 and 2	Industrial CR with storage phosphor imaging plates Classification of systems and general principles of application

Table 1-20. European norms for industrial radiography



## Literature and references

1. Industrial Radiology: Theory and Practice (English)  
R. Halmshaw. Applied Science Publishers Ltd. London and New Jersey, 1982.
2. Niet-destructief onderzoek. ISBN 90-407-1147-X (Dutch)  
W.J.P. Vink. Delftse Universitaire Pers.
3. Die Röntgenprüfung, Band 7 ISBN 3-934225-07-8 (German)  
The X-ray Inspection Volume 7 ISBN 3-934255-22-1 (English translation)  
Both compiled by Dr.Ing. M. Purschke. Castell-Verlag GmbH
4. Handbook of radiographic apparatus and techniques. (English) Publication for the IIW  
by the Welding Institute, Abington, Cambridge, England.
5. Radiographic film systems: brochure issued by GE Inspection Technologies.
6. Home page : [www.geinspectiontechnologies.com](http://www.geinspectiontechnologies.com)

## Acknowledgements

Figures 9-5 and 4-17, as well as table 2-9 were copied with the publisher's consent from reference book [2] "Niet-destructief Onderzoek" by W.J.P. Vink, Delftse Universitaire Pers.

Röntgen Technische Dienst bv (Applus RTD NDT & Inspection since 2006) Rotterdam consented to the use of a number of their illustrations and graphs. Furthermore they supplied ample information for chapter 16 concerning application of the CR method and standards related to digital radiography.

\* Illustrations marked with \* are used by courtesy of Oceaneering Inspection Division.

\*\* Nanofocus is a registered trademark of Phoenix X-ray Systems, a division of GE inspection Technologies. Phoenix also provided ample information and illustrations for chapter 17 concerning magnification, X-ray microscopy and CT techniques.

\*\*\* TomoCAR is the trademark of 3D CT equipment, a mutual development of Applus RTD and BAM Berlin. Applus RTD holds the patent.

## Appendices: tables and graphs

Designation of quantity	SI -units		Formerly used		Conversion
	Name	Unit Designation	Name	Unit Designation	Old to SI
Activity (A)	Becquerel (Bq)	1/s*	Curie	Ci	1 Ci = 37 GBq
Ionization dose	Coulomb (C)	C/kg	Röntgen	R	1 R = 2.58 x 10 <sup>-4</sup> C/kg
Ionization dose rate	Coulomb (C) Ampère (A)	C/kg.s or A/kg		R/s	
Absorbed energy dose (D)	Gray (Gy)	J/kg	Rad	Rad	1 Rad = 0.01 Gy
Equivalent dose (H) H=D x RBE**	Sievert (Sv)	J/kg	Rem	Rem	1 Rem = 0.01 Sv

Table 1-3. Overview of new and old units.

\* disintegrations per second C = Coulomb = A.s

\*\* RBE = Relative Biological Effect J = Joule  
A = Ampère

See chapter 3

Material	kV
Steel	100 kV + 8 kV/mm
Aluminium	50 kV + 2 kV/mm
Plastics	20 kV + 0.2 kV/mm

Table 2-11. Rule-of-thumb values for the selection of X-ray tube voltage.

See chapter 11.





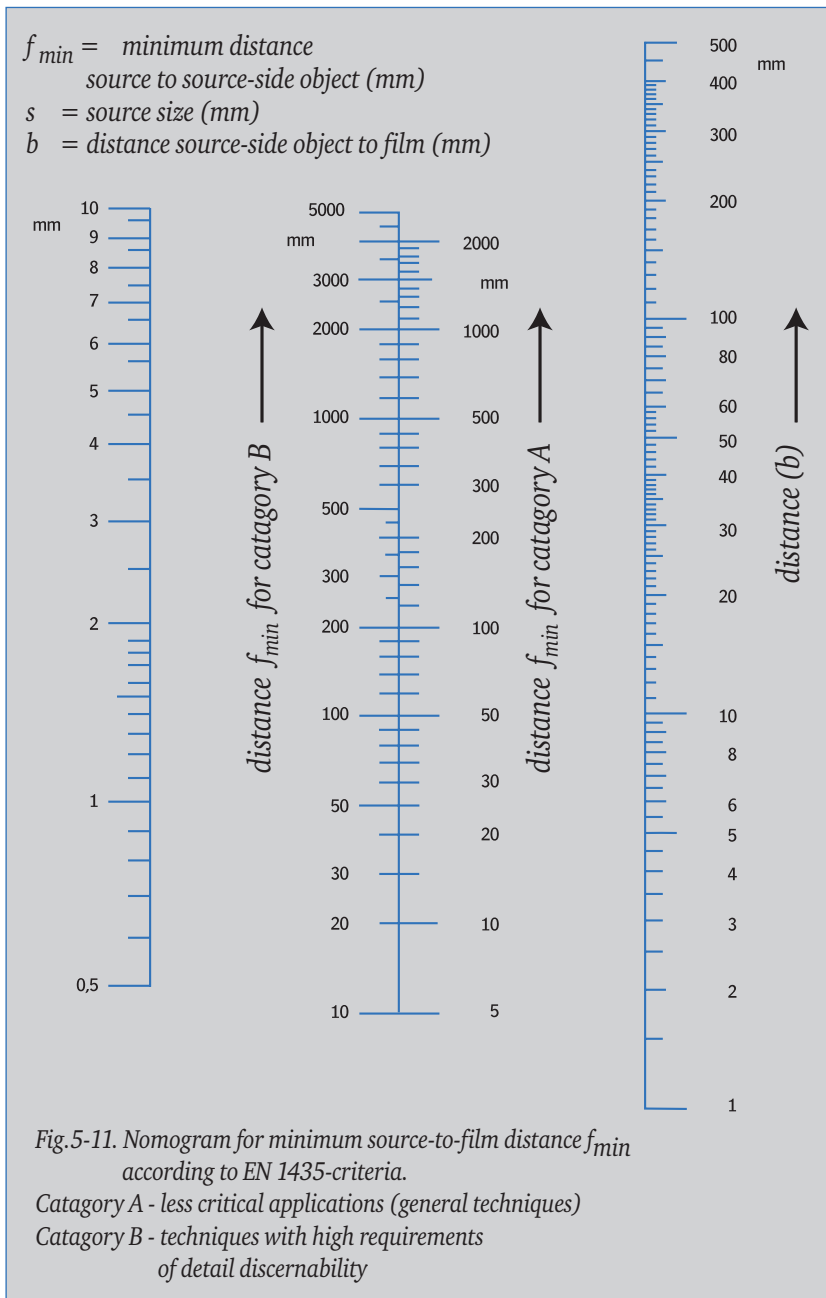

Fig. 5-11. Nomogram for minimum source-to-film distance  $f_{min}$  according to EN 1435 criteria. See chapter 11

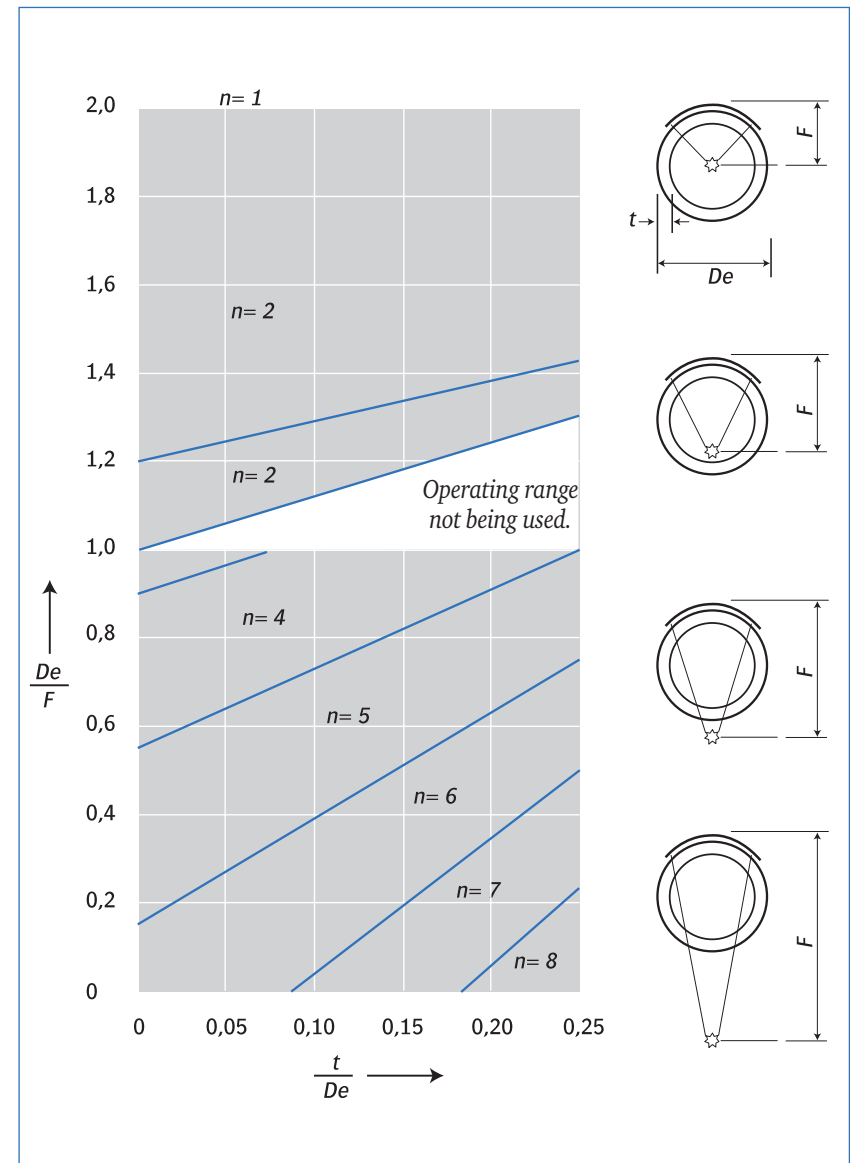

Fig. 4-12. Graph for the minimum number of exposures in accordance with EN 1435 A at maximum thickness increase of 20 %. See chapter 12



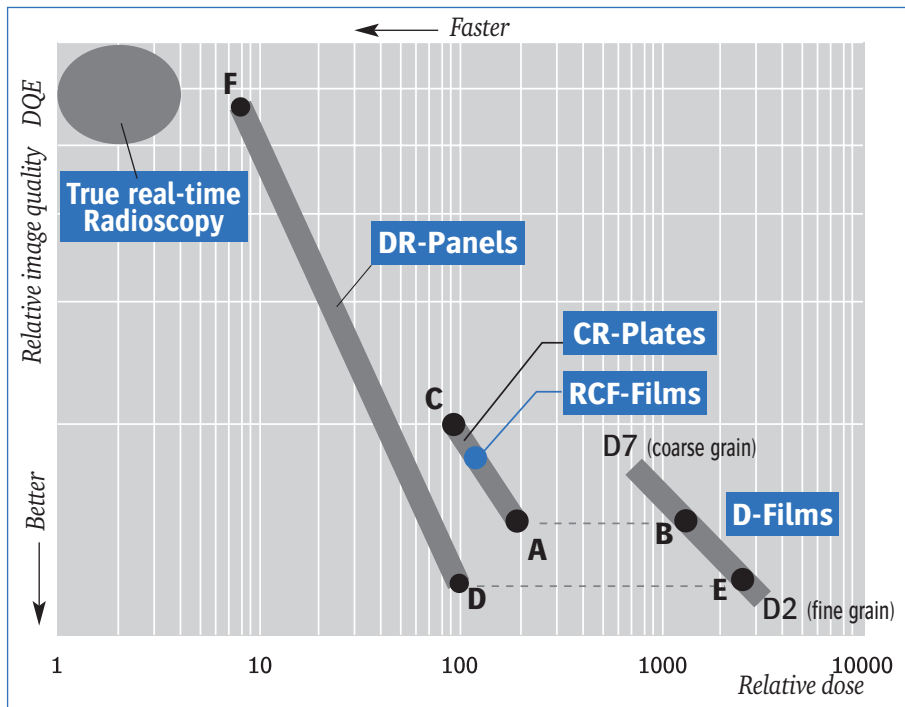

Fig. 13-16. Relative image quality and speed of the various radiographic systems.  
See chapter 16

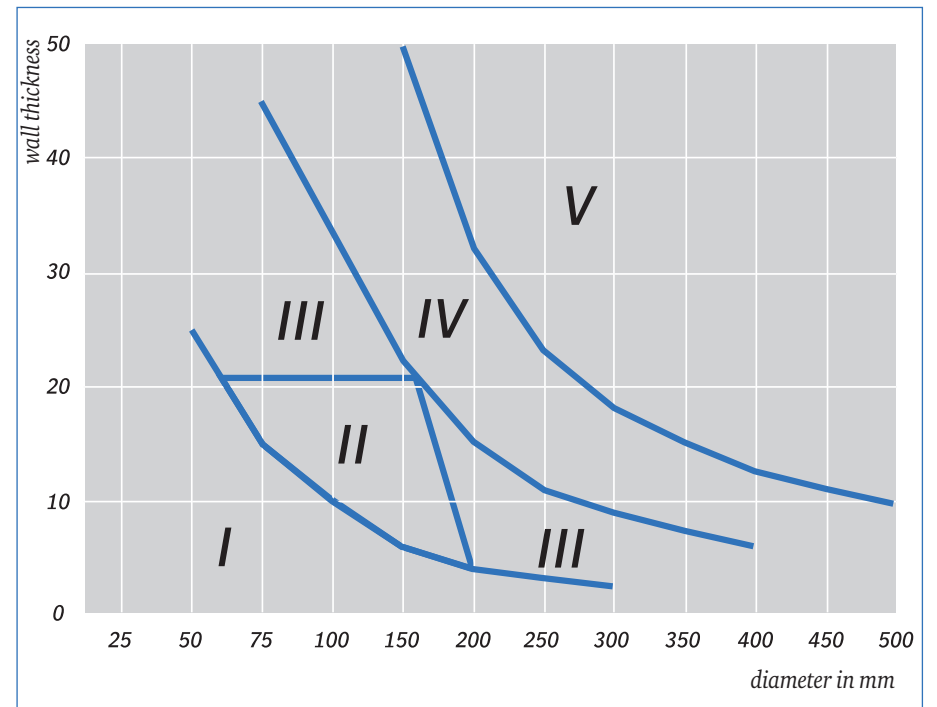

Fig. 7-18. Areas of application for selection of source, screen and filter in on-stream radiography.  
See chapter 18.

